



THE DATASHEET OF BSS123,215



Important notice

Dear Customer,

On 7 February 2017 the former NXP Standard Product business became a new company with the tradename **Nexperia**. Nexperia is an industry leading supplier of Discrete, Logic and PowerMOS semiconductors with its focus on the automotive, industrial, computing, consumer and wearable application markets

In data sheets and application notes which still contain NXP or Philips Semiconductors references, use the references to Nexperia, as shown below.

Instead of <http://www.nxp.com>, <http://www.philips.com/> or <http://www.semiconductors.philips.com/>, use <http://www.nexperia.com>

Instead of sales.addresses@www.nxp.com or sales.addresses@www.semiconductors.philips.com, use salesaddresses@nexperia.com (email)

Replace the copyright notice at the bottom of each page or elsewhere in the document, depending on the version, as shown below:

- © NXP N.V. (year). All rights reserved or © Koninklijke Philips Electronics N.V. (year). All rights reserved

Should be replaced with:

- © **Nexperia B.V. (year). All rights reserved.**

If you have any questions related to the data sheet, please contact our nearest sales office via e-mail or telephone (details via salesaddresses@nexperia.com). Thank you for your cooperation and understanding,

Kind regards,

Team Nexperia

N-channel TrenchMOS™ transistor Logic level FET

BSS123

FEATURES

- 'Trench' technology
- Extremely fast switching
- Logic level compatible
- Subminiature surface mounting package

SYMBOL

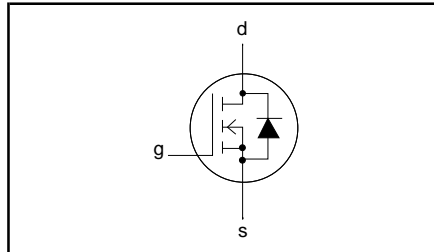

QUICK REFERENCE DATA

$V_{DSS} = 100\text{ V}$
$I_D = 150\text{ mA}$
$R_{DS(ON)} \leq 6\ \Omega\ (V_{GS} = 10\text{ V})$

GENERAL DESCRIPTION

N-channel enhancement mode field-effect transistor in a plastic envelope using 'trench' technology.

Applications:-

- Relay driver
- High-speed line driver
- Telephone ringer

The BSS123 is supplied in the SOT23 subminiature surface mounting package.

PINNING

PIN	DESCRIPTION
1	gate
2	source
3	drain

SOT23

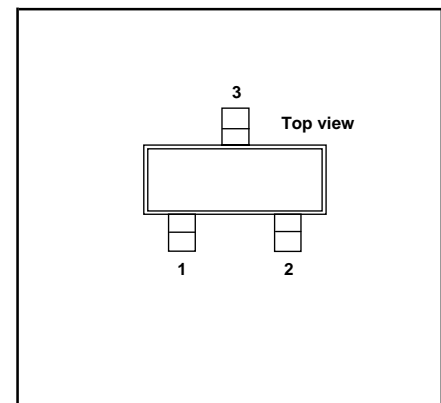

LIMITING VALUES

Limiting values in accordance with the Absolute Maximum System (IEC 134)

SYMBOL	PARAMETER	CONDITIONS	MIN.	MAX.	UNIT
V_{DSS}	Drain-source voltage	$T_j = 25\text{ °C to }150\text{ °C}$	-	100	V
V_{DGR}	Drain-gate voltage	$T_j = 25\text{ °C to }150\text{ °C}; R_{GS} = 20\text{ k}\Omega$	-	100	V
V_{GS}	Gate-source voltage		-	± 20	V
I_D	Continuous drain current	$T_a = 25\text{ °C}$	-	150	mA
I_{DM}	Pulsed drain current	$T_a = 25\text{ °C}$	-	600	mA
P_D	Total power dissipation	$T_a = 25\text{ °C}$	-	0.25	W
T_j, T_{stg}	Operating junction and storage temperature		- 55	150	°C

THERMAL RESISTANCES

SYMBOL	PARAMETER	CONDITIONS	TYP.	MAX.	UNIT
$R_{th\ j-a}$	Thermal resistance junction to ambient	surface mounted on FR4 board	500	-	K/W

N-channel TrenchMOS™ transistor

Logic level FET

BSS123

ELECTRICAL CHARACTERISTICS

$T_j = 25^\circ\text{C}$ unless otherwise specified

SYMBOL	PARAMETER	CONDITIONS	MIN.	TYP.	MAX.	UNIT
$V_{(BR)DSS}$	Drain-source breakdown voltage	$V_{GS} = 0\text{ V}; I_D = 10\ \mu\text{A}$	100	130	-	V
$V_{GS(TO)}$	Gate threshold voltage	$V_{DS} = V_{GS}; I_D = 1\ \text{mA}$	1	2	2.8	V
$R_{DS(ON)}$	Drain-source on-state resistance	$V_{GS} = 10\ \text{V}; I_D = 120\ \text{mA}$	-	3.5	6	Ω
g_{fs}	Forward transconductance	$V_{DS} = 25\ \text{V}; I_D = 120\ \text{mA}$	-	350	-	mS
I_{DSS}	Zero gate voltage drain current	$V_{DS} = 60\ \text{V}; V_{GS} = 0\ \text{V}$	-	10	100	nA
I_{GSS}	Gate source leakage current	$V_{GS} = \pm 20\ \text{V}; V_{DS} = 0\ \text{V}$	-	10	100	nA
t_{on}	Turn-on time	$V_{DD} = 50\ \text{V}; R_D = 250\ \Omega; V_{GS} = 10\ \text{V}; R_G = 50\ \Omega; \text{Resistive load}$	-	3	10	ns
t_{off}	Turn-off time		-	12	20	ns
C_{iss}	Input capacitance	$V_{GS} = 0\ \text{V}; V_{DS} = 25\ \text{V}; f = 1\ \text{MHz}$	-	23	40	pF
C_{oss}	Output capacitance		-	6	25	pF
C_{rss}	Feedback capacitance		-	4	10	pF

N-channel TrenchMOS™ transistor
Logic level FET

BSS123

MECHANICAL DATA

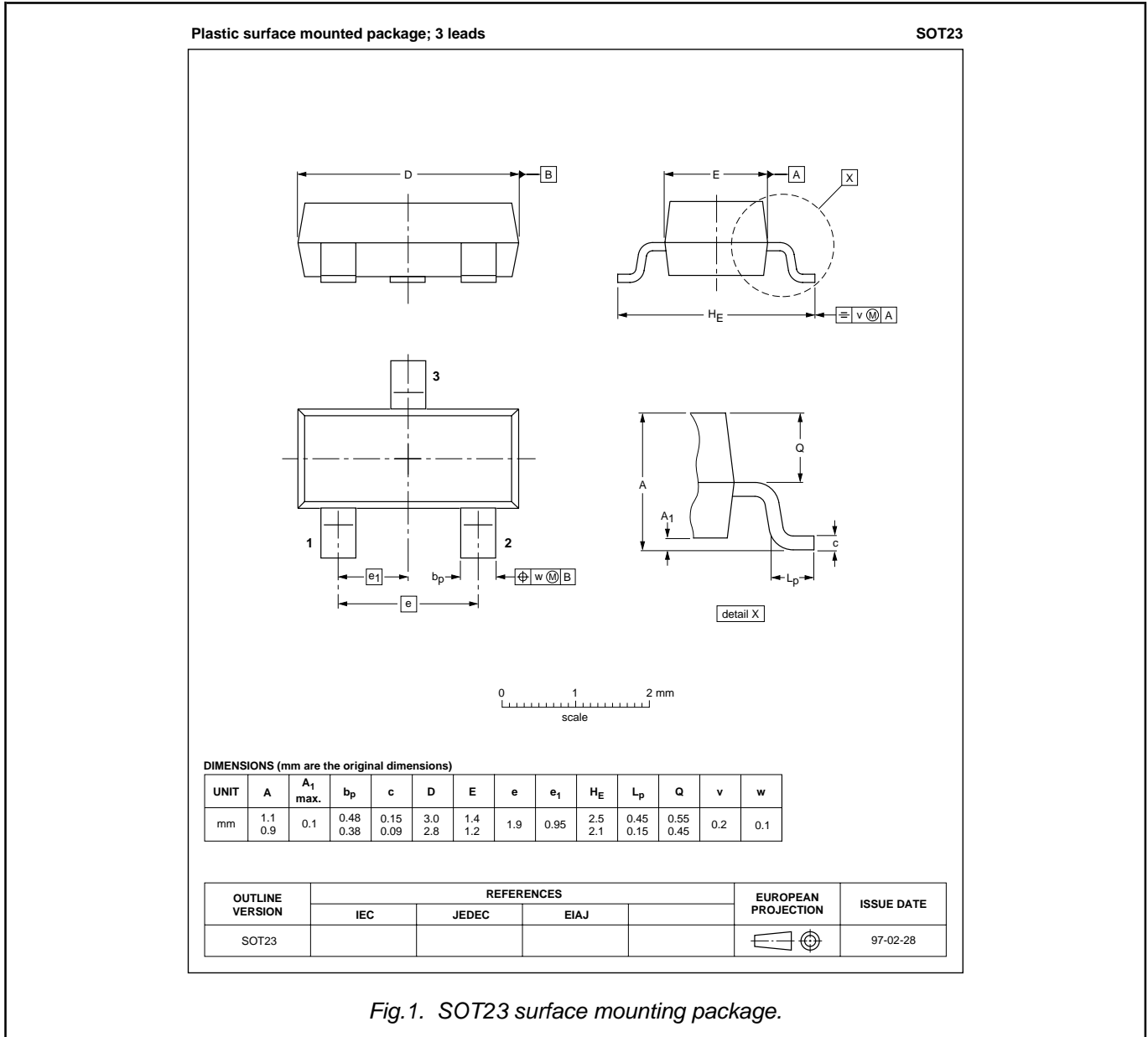

Fig.1. SOT23 surface mounting package.

Notes

1. This product is supplied in anti-static packaging. The gate-source input must be protected against static discharge during transport or handling.
2. Refer to SMD Footprint Design and Soldering Guidelines, Data Handbook SC18.
3. Epoxy meets UL94 V0 at 1/8".

N-channel TrenchMOS™ transistor

Logic level FET

BSS123

DEFINITIONS

Data sheet status	
Objective specification	This data sheet contains target or goal specifications for product development.
Preliminary specification	This data sheet contains preliminary data; supplementary data may be published later.
Product specification	This data sheet contains final product specifications.
Limiting values	
Limiting values are given in accordance with the Absolute Maximum Rating System (IEC 134). Stress above one or more of the limiting values may cause permanent damage to the device. These are stress ratings only and operation of the device at these or at any other conditions above those given in the Characteristics sections of this specification is not implied. Exposure to limiting values for extended periods may affect device reliability.	
Application information	
Where application information is given, it is advisory and does not form part of the specification.	
© Philips Electronics N.V. 2000	
All rights are reserved. Reproduction in whole or in part is prohibited without the prior written consent of the copyright owner.	
The information presented in this document does not form part of any quotation or contract, it is believed to be accurate and reliable and may be changed without notice. No liability will be accepted by the publisher for any consequence of its use. Publication thereof does not convey nor imply any license under patent or other industrial or intellectual property rights.	

LIFE SUPPORT APPLICATIONS





These products are not designed for use in life support appliances, devices or systems where malfunction of these products can be reasonably expected to result in personal injury. Philips customers using or selling these products for use in such applications do so at their own risk and agree to fully indemnify Philips for any damages resulting from such improper use or sale.

Looking for pricing, stock, or lifecycle information?

Click below to explore more details on WIN SOURCE:

-  [View BSS123,215 on WIN SOURCE](#)
-  [Nexperia USA Inc. Information](#)

Optimize Your Supply Chain with WIN SOURCE Solutions

-  Global Sourcing Solution
-  Obsolete Management
-  Cost Control Management
-  Shortage Management
-  Alternative Solution
-  Excess Inventory Management