



THE DATASHEET OF BAS20LT1G



BAS19L, BAS20L, BAS21L, BAS21DW5

High Voltage Switching Diode

Features

- These Devices are Pb-Free, Halogen Free/BFR Free and are RoHS Compliant
- S and NSV Prefixes for Automotive and Other Applications Requiring Unique Site and Control Change Requirements; AEC-Q101 Qualified and PPAP Capable

MAXIMUM RATINGS

Rating	Symbol	Value	Unit
Continuous Reverse Voltage	V_R	120 200 250	Vdc
Repetitive Peak Reverse Voltage	V_{RRM}	120 200 250	Vdc
Continuous Forward Current	I_F	200	mAdc
Peak Forward Surge Current (1/2 Cycle, Sine Wave, 60 Hz)	I_{FSM}	2	A
Repetitive Peak Forward Current (Pulse Train: $T_{ON} = 1$ s, $T_{OFF} = 0.5$ s)	I_{FRM}	0.6	A
Junction and Storage Temperature Range	T_J, T_{stg}	-55 to +150	°C
Power Dissipation (Note 1)	P_D	385	mW
Electrostatic Discharge	ESD	HM < 500 MM < 400	V

Stresses exceeding those listed in the Maximum Ratings table may damage the device. If any of these limits are exceeded, device functionality should not be assumed, damage may occur and reliability may be affected.

1. Mounted on FR-5 Board = 1.0 x 0.75 x 0.062 in.



ON Semiconductor®

www.onsemi.com

HIGH VOLTAGE SWITCHING DIODE

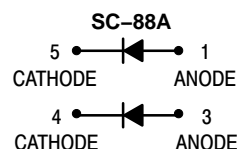
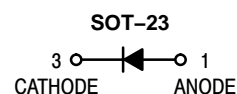

MARKING DIAGRAMS

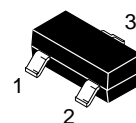

SOT-23 (TO-236)
CASE 318
STYLE 8

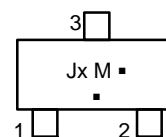

SC-88A (SOT-353)
CASE 419A

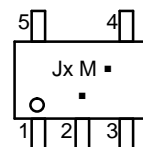

x = P, R, or S
P = BAS19L
R = BAS20L
S = BAS21L or BAS21DW5
M = Date Code
▪ = Pb-Free Package

(Note: Microdot may be in either location)

*Date Code orientation and/or overbar may vary depending upon the manufacturing location.

ORDERING INFORMATION

See detailed ordering and shipping information in the package dimensions section on page 4 of this data sheet.

BAS19L, BAS20L, BAS21L, BAS21DW5

Thermal Characteristics (SOT-23)

Characteristic	Symbol	Max	Unit
Total Device Dissipation FR-5 Board (Note 2) $T_A = 25^\circ\text{C}$ Derate above 25°C	P_D	225	mW
		1.8	mW/ $^\circ\text{C}$
Thermal Resistance Junction-to-Ambient (SOT-23)	$R_{\theta JA}$	556	$^\circ\text{C/W}$
Total Device Dissipation Alumina Substrate (Note 3) $T_A = 25^\circ\text{C}$ Derate above 25°C	P_D	300	mW
		2.4	mW/ $^\circ\text{C}$
Thermal Resistance Junction-to-Ambient	$R_{\theta JA}$	417	$^\circ\text{C/W}$
Junction and Storage Temperature Range	T_J, T_{stg}	-55 to +150	$^\circ\text{C}$

Thermal Characteristics (SC-88A)

Characteristic	Symbol	Max	Unit
Power Dissipation (Note 4)	P_D	385	mW
Thermal Resistance – Junction-to-Ambient Derate Above 25°C	$R_{\theta JA}$	328	$^\circ\text{C/W}$
		3.0	mW/ $^\circ\text{C}$
Maximum Junction Temperature	T_{Jmax}	150	$^\circ\text{C}$
Operating Junction and Storage Temperature Range	T_J, T_{stg}	-55 to +150	$^\circ\text{C}$

2. FR-5 = 1.0 × 0.75 × 0.062 in.

3. Alumina = 0.4 × 0.3 × 0.024 in. 99.5% alumina.

4. Mounted on FR-5 Board = 1.0 × 0.75 × 0.062 in.

Electrical Characteristics ($T_A = 25^\circ\text{C}$ unless otherwise noted)

Characteristic	Symbol	Min	Max	Unit	
Reverse Voltage Leakage Current ($V_R = 100$ Vdc) ($V_R = 150$ Vdc) ($V_R = 200$ Vdc) ($V_R = 100$ Vdc, $T_J = 150^\circ\text{C}$) ($V_R = 150$ Vdc, $T_J = 150^\circ\text{C}$) ($V_R = 200$ Vdc, $T_J = 150^\circ\text{C}$)	I_R	BAS19	–	0.1	μAdc
		BAS20	–	0.1	
		BAS21	–	0.1	
		BAS19	–	100	
		BAS20	–	100	
		BAS21	–	100	
Reverse Breakdown Voltage ($I_{BR} = 100$ μAdc) ($I_{BR} = 100$ μAdc) ($I_{BR} = 100$ μAdc)	$V_{(BR)}$	BAS19	120	–	Vdc
		BAS20	200	–	
		BAS21	250	–	
Forward Voltage ($I_F = 100$ mAdc) ($I_F = 200$ mAdc)	V_F	–	1.0	Vdc	
		–	1.25		
Diode Capacitance ($V_R = 0$, $f = 1.0$ MHz)	C_D	–	5.0	pF	
Reverse Recovery Time ($I_F = I_R = 30$ mAdc, $I_{R(REC)} = 3.0$ mAdc, $R_L = 100$)	t_{rr}	–	50	ns	

Product parametric performance is indicated in the Electrical Characteristics for the listed test conditions, unless otherwise noted. Product performance may not be indicated by the Electrical Characteristics if operated under different conditions.

BAS19L, BAS20L, BAS21L, BAS21DW5

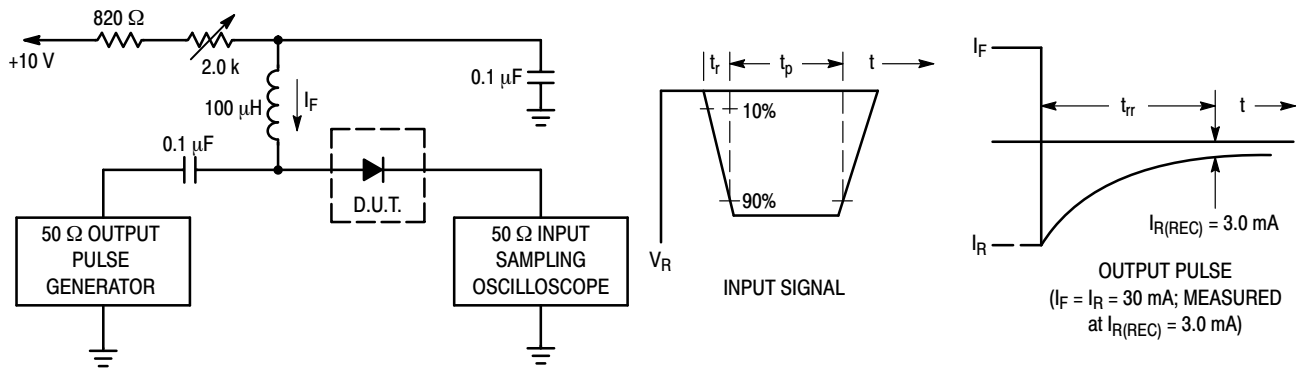

- Notes: 1. A 2.0 kΩ variable resistor adjusted for a Forward Current (I_F) of 30 mA.
 2. Input pulse is adjusted so $I_{R(\text{peak})}$ is equal to 30 mA.
 3. $t_p \gg t_{rr}$

Figure 1. Recovery Time Equivalent Test Circuit

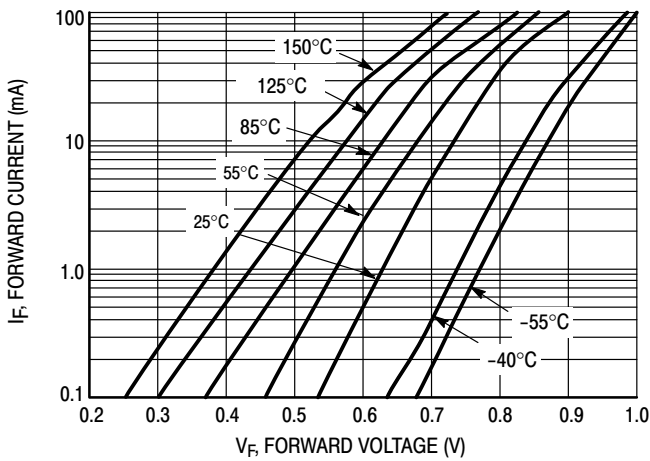

Figure 2. V_F vs. I_F

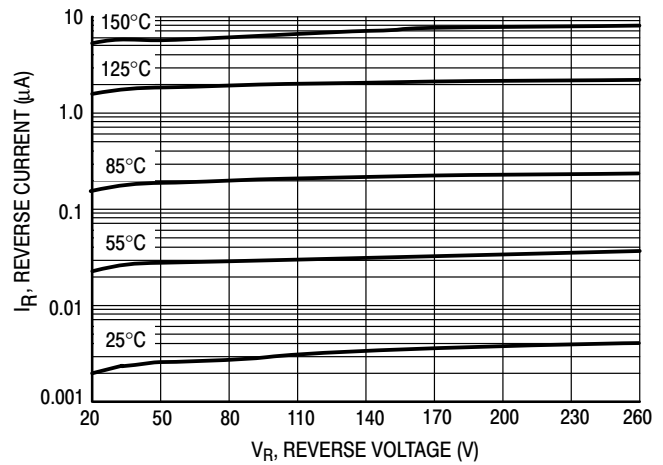

Figure 3. I_R vs. V_R

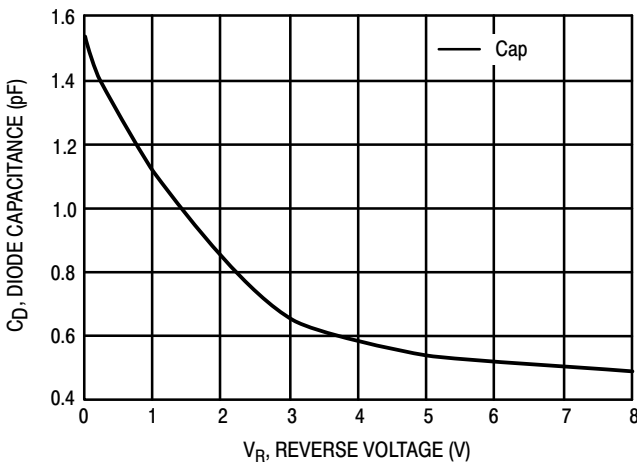

Figure 4. Capacitance

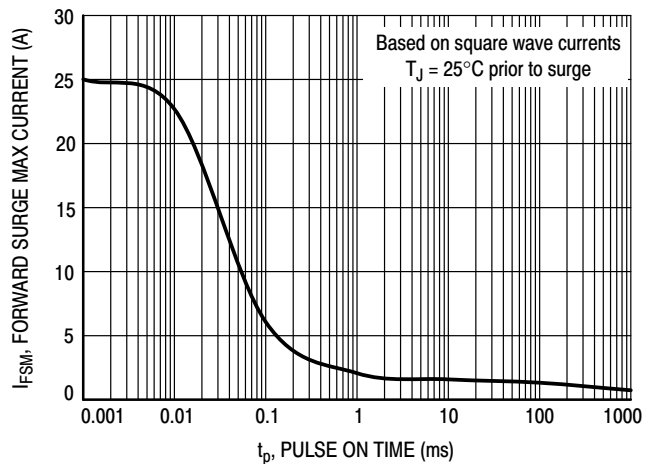

Figure 5. Forward Surge Current

BAS19L, BAS20L, BAS21L, BAS21DW5

ORDERING INFORMATION

Device	Package	Shipping†
BAS19LT1G	SOT-23 (Pb-Free)	3000 / Tape & Reel
BAS19LT3G	SOT-23 (Pb-Free)	10000 / Tape & Reel
NSVBAS19LT1G*	SOT-23 (Pb-Free)	3000 / Tape & Reel
BAS20LT1G	SOT-23 (Pb-Free)	3000 / Tape & Reel
BAS20LT3G	SOT-23 (Pb-Free)	10000 / Tape & Reel
NSVBAS20LT3G*	SOT-23 (Pb-Free)	10000 / Tape & Reel
SBAS20LT1G*	SOT-23 (Pb-Free)	3000 / Tape & Reel
BAS21LT1G	SOT-23 (Pb-Free)	3000 / Tape & Reel
SBAS21LT1G*	SOT-23 (Pb-Free)	3000 / Tape & Reel
BAS21LT3G	SOT-23 (Pb-Free)	10000 / Tape & Reel
SBAS21LT3G*	SOT-23 (Pb-Free)	10000 / Tape & Reel
BAS21DW5T1G	SC-88A (Pb-Free)	3000 / Tape & Reel
SBAS21DW5T1G*	SC-88A (Pb-Free)	3000 / Tape & Reel
SBAS21DW5T3G*	SC-88A (Pb-Free)	10000 / Tape & Reel

†For information on tape and reel specifications, including part orientation and tape sizes, please refer to our Tape and Reel Packaging Specifications Brochure, BRD8011/D.

*S and NSV Prefixes for Automotive and Other Applications Requiring Unique Site and Control Change Requirements; AEC-Q101 Qualified and PPAP Capable.

BAS19L, BAS20L, BAS21L, BAS21DW5

PACKAGE DIMENSIONS

SOT-23 (TO-236)
CASE 318-08
ISSUE AR

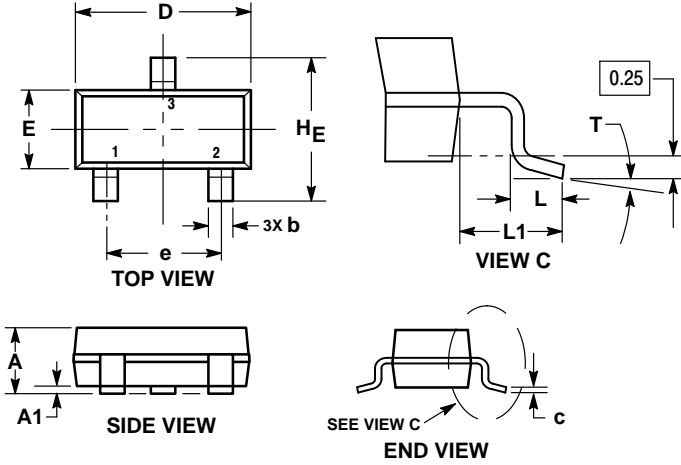

NOTES:

1. DIMENSIONING AND TOLERANCING PER ASME Y14.5M, 1994.
2. CONTROLLING DIMENSION: MILLIMETERS.
3. MAXIMUM LEAD THICKNESS INCLUDES LEAD FINISH. MINIMUM LEAD THICKNESS IS THE MINIMUM THICKNESS OF THE BASE MATERIAL.
4. DIMENSIONS D AND E DO NOT INCLUDE MOLD FLASH, PROTRUSIONS, OR GATE BURRS.

DIM	MILLIMETERS			INCHES		
	MIN	NOM	MAX	MIN	NOM	MAX
A	0.89	1.00	1.11	0.035	0.039	0.044
A1	0.01	0.06	0.10	0.000	0.002	0.004
b	0.37	0.44	0.50	0.015	0.017	0.020
c	0.08	0.14	0.20	0.003	0.006	0.008
D	2.80	2.90	3.04	0.110	0.114	0.120
E	1.20	1.30	1.40	0.047	0.051	0.055
e	1.78	1.90	2.04	0.070	0.075	0.080
L	0.30	0.43	0.55	0.012	0.017	0.022
L1	0.35	0.54	0.69	0.014	0.021	0.027
HE	2.10	2.40	2.64	0.083	0.094	0.104
T	0°	—	10°	0°	—	10°

STYLE 8:

- PIN 1: ANODE
- NO CONNECTION
- CATHODE

RECOMMENDED SOLDERING FOOTPRINT

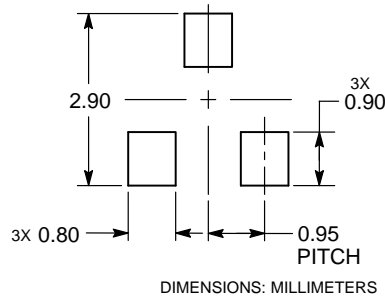

BAS19L, BAS20L, BAS21L, BAS21DW5

PACKAGE DIMENSIONS

SC-88A (SC-70-5/SOT-353)

CASE 419A-02

ISSUE L

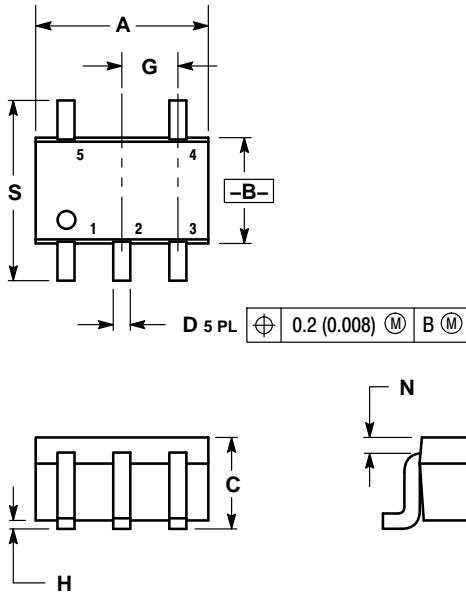

NOTES:

1. DIMENSIONING AND TOLERANCING PER ANSI Y14.5M, 1982.
2. CONTROLLING DIMENSION: INCH.
3. 419A-01 OBSOLETE. NEW STANDARD 419A-02.
4. DIMENSIONS A AND B DO NOT INCLUDE MOLD FLASH, PROTRUSIONS, OR GATE BURRS.

DIM	INCHES		MILLIMETERS	
	MIN	MAX	MIN	MAX
A	0.071	0.087	1.80	2.20
B	0.045	0.053	1.15	1.35
C	0.031	0.043	0.80	1.10
D	0.004	0.012	0.10	0.30
G	0.026 BSC		0.65 BSC	
H	---	0.004	---	0.10
J	0.004	0.010	0.10	0.25
K	0.004	0.012	0.10	0.30
N	0.008 REF		0.20 REF	
S	0.079	0.087	2.00	2.20

SOLDER FOOTPRINT

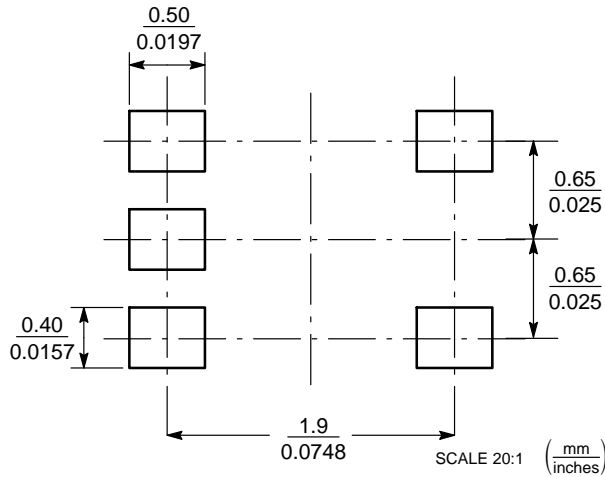

ON Semiconductor and are trademarks of Semiconductor Components Industries, LLC dba ON Semiconductor or its subsidiaries in the United States and/or other countries. ON Semiconductor owns the rights to a number of patents, trademarks, copyrights, trade secrets, and other intellectual property. A listing of ON Semiconductor's product/patent coverage may be accessed at www.onsemi.com/site/pdf/Patent-Marking.pdf. ON Semiconductor reserves the right to make changes without further notice to any products herein. ON Semiconductor makes no warranty, representation or guarantee regarding the suitability of its products for any particular purpose, nor does ON Semiconductor assume any liability arising out of the application or use of any product or circuit, and specifically disclaims any and all liability, including without limitation special, consequential or incidental damages. Buyer is responsible for its products and applications using ON Semiconductor products, including compliance with all laws, regulations and safety requirements or standards, regardless of any support or applications information provided by ON Semiconductor. "Typical" parameters which may be provided in ON Semiconductor data sheets and/or specifications can and do vary in different applications and actual performance may vary over time. All operating parameters, including "Typicals" must be validated for each customer application by customer's technical experts. ON Semiconductor does not convey any license under its patent rights nor the rights of others. ON Semiconductor products are not designed, intended, or authorized for use as a critical component in life support systems or any FDA Class 3 medical devices or medical devices with a same or similar classification in a foreign jurisdiction or any devices intended for implantation in the human body. Should Buyer purchase or use ON Semiconductor products for any such unintended or unauthorized application, Buyer shall indemnify and hold ON Semiconductor and its officers, employees, subsidiaries, affiliates, and distributors harmless against all claims, costs, damages, and expenses, and reasonable attorney fees arising out of, directly or indirectly, any claim of personal injury or death associated with such unintended or unauthorized use, even if such claim alleges that ON Semiconductor was negligent regarding the design or manufacture of the part. ON Semiconductor is an Equal Opportunity/Affirmative Action Employer. This literature is subject to all applicable copyright laws and is not for resale in any manner.

PUBLICATION ORDERING INFORMATION

LITERATURE FULFILLMENT:
Literature Distribution Center for ON Semiconductor
19521 E. 32nd Pkwy, Aurora, Colorado 80011 USA
Phone: 303-675-2175 or 800-344-3860 Toll Free USA/Canada
Fax: 303-675-2176 or 800-344-3867 Toll Free USA/Canada
Email: orderlit@onsemi.com

N. American Technical Support: 800-282-9855 Toll Free
USA/Canada
Europe, Middle East and Africa Technical Support:
Phone: 421 33 790 2910
Japan Customer Focus Center
Phone: 81-3-5817-1050

ON Semiconductor Website: www.onsemi.com
Order Literature: <http://www.onsemi.com/orderlit>
For additional information, please contact your local Sales Representative

Looking for pricing, stock, or lifecycle information?

Click below to explore more details on WIN SOURCE:

 [View BAS20LT1G on WIN SOURCE](#)

 [ON Semiconductor](#) Information

Optimize Your Supply Chain with WIN SOURCE Solutions

-  Global Sourcing Solution
-  Obsolete Management
-  Cost Control Management
-  Shortage Management
-  Alternative Solution
-  Excess Inventory Management