



**THE DATASHEET OF  
ACS725LLCTR-30AB-T**



## Automotive-Grade, Galvanically Isolated Current Sensor IC with Common-Mode Field Rejection in a Small Footprint SOIC8 Package

### FEATURES AND BENEFITS

- AEC-Q100 qualified
- Differential Hall sensing rejects common-mode fields
- 1.2 mΩ primary conductor resistance for low power loss and high inrush current withstand capability
- Integrated shield virtually eliminates capacitive coupling from current conductor to die, greatly suppressing output noise due to high dv/dt transients
- Industry-leading noise performance with greatly improved bandwidth through proprietary amplifier and filter design techniques
- High-bandwidth 120 kHz analog output for faster response times in control applications
- Filter pin allows user to filter the output for improved resolution at lower bandwidth
- Patented integrated digital temperature compensation circuitry allows for near closed loop accuracy over temperature in an open-loop sensor
- Small footprint, low-profile SOIC8 package suitable for space-constrained applications
- Filter pin simplifies bandwidth limiting for better resolution at lower frequencies

Continued on the next page...



### PACKAGE: 8-Pin SOIC (suffix LC)

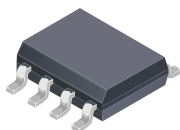

Not to scale

### DESCRIPTION

The Allegro™ ACS725 current sensor IC is an economical and precise solution for AC or DC current sensing in industrial, automotive, commercial, and communications systems. The small package is ideal for space-constrained applications while also saving costs due to reduced board area. Typical applications include motor control, load detection and management, switched-mode power supplies, and overcurrent fault protection.

The device consists of a precise, low-offset, linear Hall sensor circuit with a copper conduction path located near the surface of the die. Applied current flowing through this copper conduction path generates a magnetic field which is sensed by the integrated Hall IC and converted into a proportional voltage. The current is sensed differentially in order to reject common-mode fields, improving accuracy in magnetically noisy environments. The inherent device accuracy is optimized through the close proximity of the magnetic field to the Hall transducer. A precise, proportional voltage is provided by the low-offset, chopper-stabilized BiCMOS Hall IC, which is programmed for accuracy after packaging. The output of the device has a positive slope when an increasing current flows through the primary copper conduction path (from pins 1 and 2, to pins 3 and 4), which is the path used for current sensing. The internal resistance of this conductive path is 1.2 mΩ typical, providing low power loss.

The terminals of the conductive path are electrically isolated from the sensor leads (pins 5 through 8). This allows the ACS725 current sensor IC to be used in high-side current sense applications without the use of high-side differential amplifiers or other costly isolation techniques.

Continued on the next page...

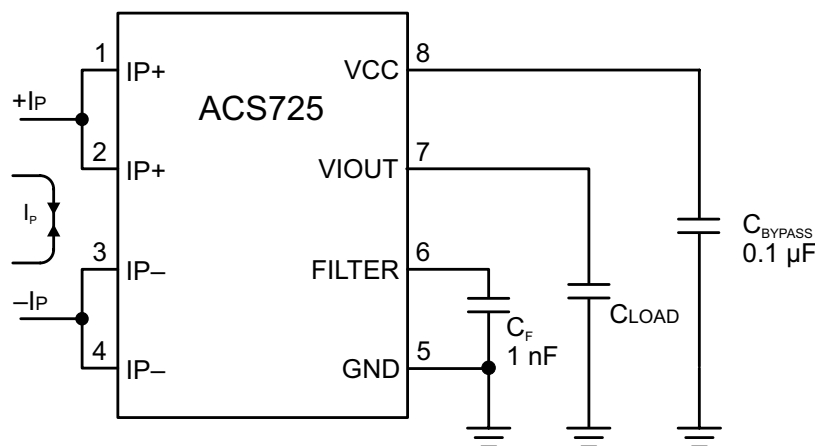

The ACS725 outputs an analog signal, V<sub>IOUT</sub>, that changes, proportionally, with the bidirectional AC or DC primary sensed current, I<sub>P</sub>, within the specified measurement range. The FILTER pin can be used to decrease the bandwidth in order to optimize the noise performance.

Typical Application

### FEATURES AND BENEFITS (continued)

- 3.3 V, single supply operation
- Output voltage proportional to AC or DC current
- Factory-trimmed sensitivity and quiescent output voltage for improved accuracy
- Chopper stabilization results in extremely stable quiescent output voltage
- Nearly zero magnetic hysteresis
- Ratiometric output from supply voltage

### DESCRIPTION (continued)

The ACS725 is provided in a small, low-profile surface-mount SOIC8 package. The leadframe is plated with 100% matte tin, which is compatible with standard lead (Pb) free printed circuit board assembly processes. Internally, the flip-chip device is considered Pb-free. However, the solder bump connections are available in a Pb-free or high-temperature Pb-based option. Part numbers followed by -S are manufactured with tin-silver-based solder bumps, making these parts Pb-free compliant without the use of RoHS exemptions. Part numbers followed by -T are manufactured with Pb-based solder bumps using allowed RoHS exemptions.

### SELECTION GUIDE

Part Number	$I_{PR}$ (A)	Sens(Typ) at $V_{CC} = 3.3\text{ V}$ (mV/A)	$T_A$ (°C)	Packing
<b>-S VARIANT</b> [1]				
ACS725LLCTR-05AB-S	±5	264	-40 to 150	Tape and Reel, 3000 pieces per reel
ACS725LLCTR-10AB-S	±10	132		
ACS725LLCTR-10AU-S	10	264		
ACS725LLCTR-20AB-S	±20	66		
ACS725LLCTR-20AU-S	20	132		
ACS725LLCTR-30AB-S	±30	44		
ACS725LLCTR-30AB-S-H [2]	±30	44		
ACS725LLCTR-30AU-S	30	88		
ACS725LLCTR-40AB-S	±40	33		
ACS725LLCTR-50AB-S	±50	26.4		
<b>-T VARIANT</b> [3]				
ACS725LLCTR-05AB-T	±5	264	-40 to 150	Tape and Reel, 3000 pieces per reel
ACS725LLCTR-10AB-T	±10	132		
ACS725LLCTR-10AU-T	10	264		
ACS725LLCTR-20AB-T	±20	66		
ACS725LLCTR-20AU-T	20	132		
ACS725LLCTR-30AB-T	±30	44		
ACS725LLCTR-30AB-T-H [2]	±30	44		
ACS725LLCTR-30AU-T	30	88		
ACS725LLCTR-40AB-T	±40	33		
ACS725LLCTR-50AB-T	±50	26.4		

[1] -S denotes the lead-free construction with tin-silver-based solder bumps.

[2] -H denotes 100% cold calibration at the Allegro factory for improved accuracy.

[3] -T denotes Pb-contained construction with Pb-based solder bumps. Operating performance of -T and -S devices are identical. -T devices are RoHS-compliant using allowed exemptions provided in Annex III and IV of Directive 2011/65/EU [Exemptions 7(a), 15, 15(a), as applicable].

### SPECIFICATIONS

#### ABSOLUTE MAXIMUM RATINGS

Characteristic	Symbol	Notes	Rating	Units
Supply Voltage	$V_{CC}$		6	V
Reverse Supply Voltage	$V_{RCC}$		-0.1	V
Output Voltage	$V_{IOUT}$		$V_{CC} + 0.5$	V
Reverse Output Voltage	$V_{RIOUT}$		-0.1	V
Operating Ambient Temperature	$T_A$	Range L	-40 to 150	°C
Junction Temperature	$T_J(\text{max})$		165	°C
Storage Temperature	$T_{stg}$		-65 to 165	°C

#### ISOLATION CHARACTERISTICS

Characteristic	Symbol	Notes	Rating	Unit
Dielectric Surge Strength Test Voltage [1]	$V_{SURGE}$	Tested $\pm 5$ pulses at 2/minute in compliance to IEC 61000-4-5 1.2 $\mu\text{s}$ (rise) / 50 $\mu\text{s}$ (width).	6000	V
Dielectric Strength Test Voltage [1]	$V_{ISO}$	Agency type-tested for 60 seconds per UL standard 60950-1 (edition 2). Production tested at $V_{ISO}$ for 1 second, in accordance with UL 60950-1 (edition 2).	2400	$V_{RMS}$
Working Voltage for Basic Isolation [1]	$V_{WVBI}$	Maximum approved working voltage for basic (single) isolation according UL 60950-1 (edition 2)	420	$V_{pk}$ or VDC
			297	$V_{rms}$
Clearance	$D_{cl}$	Minimum distance through air from IP leads to signal leads	4.2	mm
Creepage	$D_{cr}$	Minimum distance along package body from IP leads to signal leads	4.2	mm
Comparative Tracking Index	CTI	Material Group II	400 to 599	V

[1] Certification pending.

#### THERMAL CHARACTERISTICS

Characteristic	Symbol	Test Conditions*	Value	Units
Package Thermal Resistance (Junction to Ambient)	$R_{\theta JA}$	Mounted on the Allegro 85-0140 evaluation board with 800 mm <sup>2</sup> of 4 oz. copper on each side, connected to pins 1 and 2, and to pins 3 and 4, with thermal vias connecting the layers. Performance values include the power consumed by the PCB.	23	°C/W
Package Thermal Resistance (Junction to Lead)	$R_{\theta JL}$	Mounted on the Allegro ASEK725 evaluation board.	5	°C/W

\*Additional thermal information available on the Allegro website.

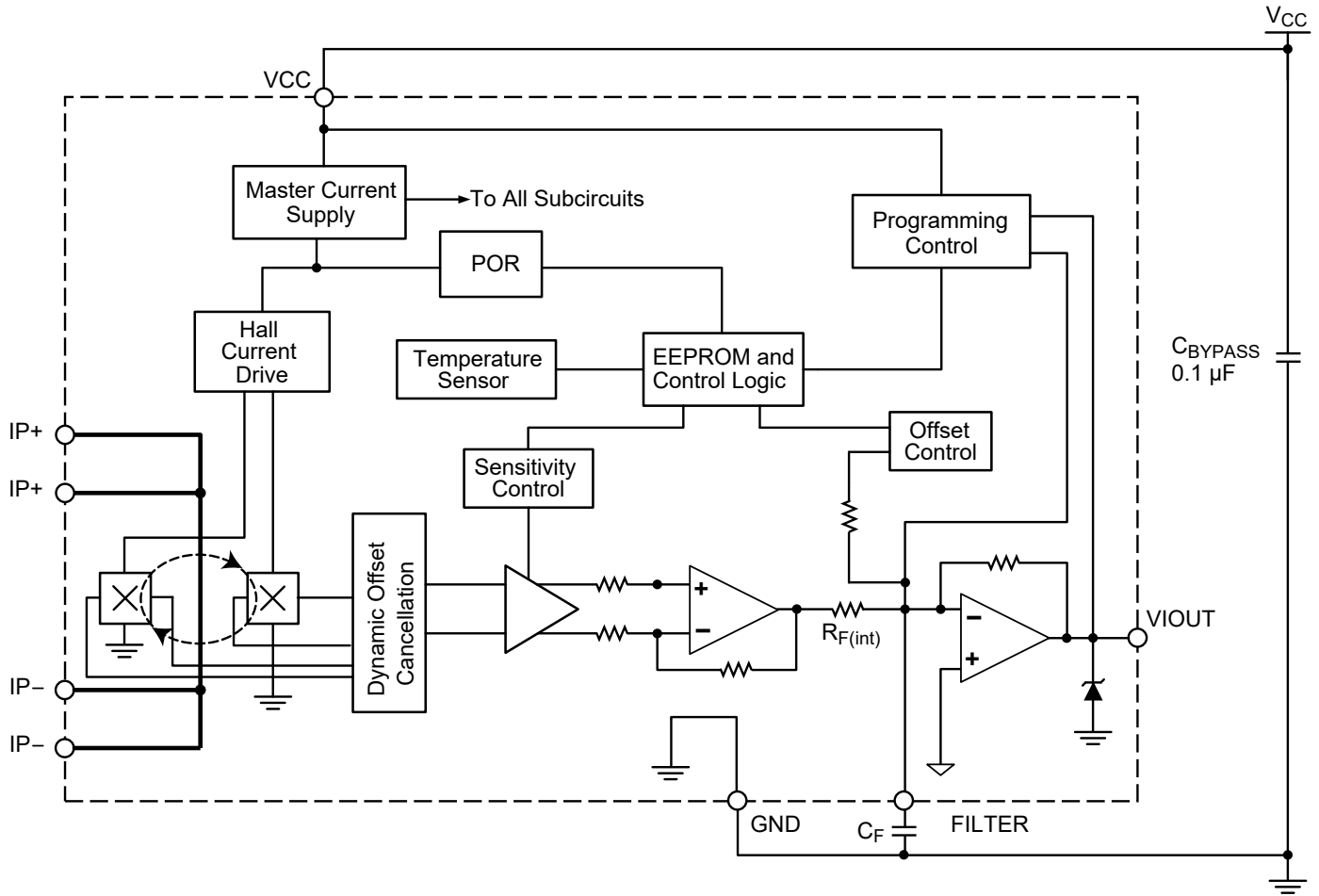

Functional Block Diagram

### Pinout Diagram and Terminal List Table

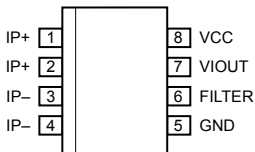

Package LC, 8-Pin SOICN  
Pinout Diagram

Terminal List Table

Number	Name	Description
1, 2	IP+	Terminals for current being sensed; fused internally
3, 4	IP-	Terminals for current being sensed; fused internally
5	GND	Signal ground terminal
6	FILTER	Terminal for external capacitor that sets bandwidth
7	VIOUT	Analog output signal
8	VCC	Device power supply terminal

### COMMON ELECTRICAL CHARACTERISTICS [1]: Valid through the full range of $T_A$ , $V_{CC} = 3.3\text{ V}$ , $C_F = 0$ , unless otherwise specified

Characteristic	Symbol	Test Conditions	Min.	Typ.	Max.	Unit
Supply Voltage	$V_{CC}$		3	3.3	3.6	V
Supply Current	$I_{CC}$	$V_{CC} = 3.3\text{ V}$ , output open	–	10	14	mA
Output Capacitance Load	$C_L$	VIOOUT to GND	–	–	10	nF
Output Resistive Load	$R_L$	VIOOUT to GND	4.7	–	–	k $\Omega$
Primary Conductor Resistance	$R_{IP}$	$T_A = 25^\circ\text{C}$	–	1.2	–	m $\Omega$
Internal Filter Resistance [2]	$R_{F(int)}$		–	1.8	–	k $\Omega$
Common Mode Field Rejection Ratio	CMFRR	Uniform external magnetic field	–	40	–	dB
Primary Hall Coupling Factor	G1	$T_A = 25^\circ\text{C}$	–	11	–	G/A
Secondary Hall Coupling Factor	G2	$T_A = 25^\circ\text{C}$	–	2.8	–	G/A
Hall plate Sensitivity Matching	Sens <sub>match</sub>	$T_A = 25^\circ\text{C}$	–	$\pm 1$	–	%
Rise Time	$t_r$	$I_P = I_P(max)$ , $T_A = 25^\circ\text{C}$ , $C_L = 1\text{ nF}$	–	3	–	$\mu\text{s}$
Propagation Delay	$t_{pd}$	$I_P = I_P(max)$ , $T_A = 25^\circ\text{C}$ , $C_L = 1\text{ nF}$	–	2	–	$\mu\text{s}$
Response Time	$t_{RESPONSE}$	$I_P = I_P(max)$ , $T_A = 25^\circ\text{C}$ , $C_L = 1\text{ nF}$	–	4	–	$\mu\text{s}$
Bandwidth	BW	Small signal $-3\text{ dB}$ ; $C_L = 1\text{ nF}$	–	120	–	kHz
Noise Density	$I_{ND}$	Input referenced noise density; $T_A = 25^\circ\text{C}$ , $C_L = 1\text{ nF}$	–	200	–	$\mu\text{A}_{(rms)}/\sqrt{\text{Hz}}$
Noise	$I_N$	Input referenced noise: $C_F = 4.7\text{ nF}$ , $C_L = 1\text{ nF}$ , BW = 18 kHz, $T_A = 25^\circ\text{C}$	–	27	–	$\text{mA}_{(rms)}$
Nonlinearity	$E_{LIN}$	Through full range of $I_P$	$-1.5$	–	$+1.5$	%
Sensitivity Ratiometry Coefficient	SENS_RAT_COEF	$V_{CC} = 3.0\text{ to }3.6\text{ V}$ , $T_A = 25^\circ\text{C}$	–	1.3	–	–
Zero Current Output Ratiometry Coefficient	QVO_RAT_COEF	$V_{CC} = 3.0\text{ to }3.6\text{ V}$ , $T_A = 25^\circ\text{C}$	–	1	–	–
Saturation Voltage [3]	$V_{OH}$	$R_L = 4.7\text{ k}\Omega$	–	$V_{CC} - 0.3$	–	V
	$V_{OL}$	$R_L = 4.7\text{ k}\Omega$	–	0.3	–	V
Power-On Time	$t_{PO}$	Output reaches 90% of steady-state level, $T_A = 25^\circ\text{C}$ , $I_P = I_{PR}(max)$ applied	–	80	–	$\mu\text{s}$
Shorted Output to Ground Current	$I_{sc(gnd)}$	$T_A = 25^\circ\text{C}$	–	3.3	–	mA
Shorted Output to $V_{CC}$ Current	$I_{sc(vcc)}$	$T_A = 25^\circ\text{C}$	–	45	–	mA

[1] Device may be operated at higher primary current levels,  $I_P$ , ambient temperatures,  $T_A$ , and internal leadframe temperatures, provided the Maximum Junction Temperature,  $T_J(max)$ , is not exceeded.

[2]  $R_{F(int)}$  forms an RC circuit via the FILTER pin.

[3] The sensor IC will continue to respond to current beyond the range of  $I_P$  until the high or low saturation voltage; however, the nonlinearity in this region will be worse than through the rest of the measurement range.

**xLLCTR-05AB PERFORMANCE CHARACTERISTICS:**  $T_A$  Range L, valid at  $T_A = -40^\circ\text{C}$  to  $150^\circ\text{C}$ ,  $V_{CC} = 3.3\text{ V}$ , unless otherwise specified

Characteristic	Symbol	Test Conditions	Min.	Typ. [1]	Max.	Unit
<b>NOMINAL PERFORMANCE</b>						
Current Sensing Range	$I_{PR}$		-5	-	5	A
Sensitivity	Sens	$I_{PR(\min)} < I_P < I_{PR(\max)}$	-	264	-	mV/A
Zero Current Output Voltage	$V_{IOUT(Q)}$	Unidirectional; $I_P = 0\text{ A}$	-	$V_{CC} \times 0.5$	-	V
<b>ACCURACY PERFORMANCE</b>						
Total Output Error [2]	$E_{TOT}$	$I_P = I_{PR(\max)}$ ; $T_A = 25^\circ\text{C}$ to $150^\circ\text{C}$	-2.5	$\pm 0.9$	2.5	%
		$I_P = I_{PR(\max)}$ ; $T_A = -40^\circ\text{C}$ to $25^\circ\text{C}$	-6	$\pm 4$	6	%
<b>TOTAL OUTPUT ERROR COMPONENTS [3] <math>E_{TOT} = E_{SENS} + 100 \times V_{OE}/(\text{Sens} \times I_P)</math></b>						
Sensitivity Error	$E_{sens}$	$I_P = I_{PR(\max)}$ ; $T_A = 25^\circ\text{C}$ to $150^\circ\text{C}$	-1.5	$\pm 0.9$	1.5	%
		$I_P = I_{PR(\max)}$ ; $T_A = -40^\circ\text{C}$ to $25^\circ\text{C}$	-5.5	$\pm 4$	5.5	%
Offset Voltage	$V_{OE}$	$I_P = 0\text{ A}$ ; $T_A = 25^\circ\text{C}$ to $150^\circ\text{C}$	-15	$\pm 5$	15	mV
		$I_P = 0\text{ A}$ ; $T_A = -40^\circ\text{C}$ to $25^\circ\text{C}$	-30	$\pm 15$	30	mV
<b>LIFETIME DRIFT CHARACTERISTICS</b>						
Sensitivity Error Lifetime Drift	$E_{sens\_drift}$		-3	$\pm 1$	3	%
Total Output Error Lifetime Drift	$E_{tot\_drift}$		-3	$\pm 1$	3	%

[1] Typical values with  $\pm$  are 3 sigma values

[2] Percentage of  $I_P$ , with  $I_P = I_{PR(\max)}$

[3] A single part will not have both the maximum/minimum sensitivity error and maximum/minimum offset voltage, as that would violate the maximum/minimum total output error specification. Also, 3 sigma distribution values are combined by taking the square root of the sum of the squares. See Application Information section.

**xLLCTR-10AB PERFORMANCE CHARACTERISTICS:**  $T_A$  Range L, valid at  $T_A = -40^\circ\text{C}$  to  $150^\circ\text{C}$ ,  $V_{CC} = 3.3\text{ V}$ , unless otherwise specified

Characteristic	Symbol	Test Conditions	Min.	Typ. [1]	Max.	Unit
<b>NOMINAL PERFORMANCE</b>						
Current Sensing Range	$I_{PR}$		-10	-	10	A
Sensitivity	Sens	$I_{PR(\min)} < I_P < I_{PR(\max)}$	-	132	-	mV/A
Zero Current Output Voltage	$V_{IOUT(Q)}$	Unidirectional; $I_P = 0\text{ A}$	-	$V_{CC} \times 0.5$	-	V
<b>ACCURACY PERFORMANCE</b>						
Total Output Error [2]	$E_{TOT}$	$I_P = I_{PR(\max)}$ ; $T_A = 25^\circ\text{C}$ to $150^\circ\text{C}$	-2	$\pm 0.8$	2	%
		$I_P = I_{PR(\max)}$ ; $T_A = -40^\circ\text{C}$ to $25^\circ\text{C}$	-6	$\pm 4$	6	%
<b>TOTAL OUTPUT ERROR COMPONENTS [3] <math>E_{TOT} = E_{SENS} + 100 \times V_{OE}/(\text{Sens} \times I_P)</math></b>						
Sensitivity Error	$E_{sens}$	$I_P = I_{PR(\max)}$ ; $T_A = 25^\circ\text{C}$ to $150^\circ\text{C}$	-1.5	$\pm 0.8$	1.5	%
		$I_P = I_{PR(\max)}$ ; $T_A = -40^\circ\text{C}$ to $25^\circ\text{C}$	-5.5	$\pm 4$	5.5	%
Offset Voltage	$V_{OE}$	$I_P = 0\text{ A}$ ; $T_A = 25^\circ\text{C}$ to $150^\circ\text{C}$	-10	$\pm 4$	10	mV
		$I_P = 0\text{ A}$ ; $T_A = -40^\circ\text{C}$ to $25^\circ\text{C}$	-30	$\pm 15$	30	mV
<b>LIFETIME DRIFT CHARACTERISTICS</b>						
Sensitivity Error Lifetime Drift	$E_{sens\_drift}$		-3	$\pm 1$	3	%
Total Output Error Lifetime Drift	$E_{tot\_drift}$		-3	$\pm 1$	3	%

[1] Typical values with  $\pm$  are 3 sigma values

[2] Percentage of  $I_P$ , with  $I_P = I_{PR(\max)}$

[3] A single part will not have both the maximum/minimum sensitivity error and maximum/minimum offset voltage, as that would violate the maximum/minimum total output error specification. Also, 3 sigma distribution values are combined by taking the square root of the sum of the squares. See Application Information section.

**xLLCTR-10AU PERFORMANCE CHARACTERISTICS:**  $T_A$  Range L, valid at  $T_A = -40^\circ\text{C}$  to  $150^\circ\text{C}$ ,  $V_{CC} = 3.3\text{ V}$ , unless otherwise specified

Characteristic	Symbol	Test Conditions	Min.	Typ. [1]	Max.	Unit
<b>NOMINAL PERFORMANCE</b>						
Current Sensing Range	$I_{PR}$		0	–	10	A
Sensitivity	Sens	$I_{PR(\min)} < I_P < I_{PR(\max)}$	–	264	–	mV/A
Zero Current Output Voltage	$V_{IOUT(Q)}$	Unidirectional; $I_P = 0\text{ A}$	–	$V_{CC} \times 0.1$	–	V
<b>ACCURACY PERFORMANCE</b>						
Total Output Error [2]	$E_{TOT}$	$I_P = I_{PR(\max)}$ ; $T_A = 25^\circ\text{C}$ to $150^\circ\text{C}$	–2.5	$\pm 0.9$	2.5	%
		$I_P = I_{PR(\max)}$ ; $T_A = -40^\circ\text{C}$ to $25^\circ\text{C}$	–6	$\pm 4$	6	%
<b>TOTAL OUTPUT ERROR COMPONENTS [3] <math>E_{TOT} = E_{SENS} + 100 \times V_{OE}/(\text{Sens} \times I_P)</math></b>						
Sensitivity Error	$E_{sens}$	$I_P = I_{PR(\max)}$ ; $T_A = 25^\circ\text{C}$ to $150^\circ\text{C}$	–2	$\pm 0.9$	2	%
		$I_P = I_{PR(\max)}$ ; $T_A = -40^\circ\text{C}$ to $25^\circ\text{C}$	–5.5	$\pm 4$	5.5	%
Offset Voltage	$V_{OE}$	$I_P = 0\text{ A}$ ; $T_A = 25^\circ\text{C}$ to $150^\circ\text{C}$	–15	$\pm 5$	15	mV
		$I_P = 0\text{ A}$ ; $T_A = -40^\circ\text{C}$ to $25^\circ\text{C}$	–30	$\pm 15$	30	mV
<b>LIFETIME DRIFT CHARACTERISTICS</b>						
Sensitivity Error Lifetime Drift	$E_{sens\_drift}$		–3	$\pm 1$	3	%
Total Output Error Lifetime Drift	$E_{tot\_drift}$		–3	$\pm 1$	3	%

[1] Typical values with  $\pm$  are 3 sigma values

[2] Percentage of  $I_P$ , with  $I_P = I_{PR(\max)}$ .

[3] A single part will not have both the maximum/minimum sensitivity error and maximum/minimum offset voltage, as that would violate the maximum/minimum total output error specification. Also, 3 sigma distribution values are combined by taking the square root of the sum of the squares. See Application Information section.

**xLLCTR-20AU PERFORMANCE CHARACTERISTICS:**  $T_A$  Range L, valid at  $T_A = -40^\circ\text{C}$  to  $150^\circ\text{C}$ ,  $V_{CC} = 3.3\text{ V}$ , unless otherwise specified

Characteristic	Symbol	Test Conditions	Min.	Typ. [1]	Max.	Unit
<b>NOMINAL PERFORMANCE</b>						
Current Sensing Range	$I_{PR}$		0	–	20	A
Sensitivity	Sens	$I_{PR(\min)} < I_P < I_{PR(\max)}$	–	132	–	mV/A
Zero Current Output Voltage	$V_{IOUT(Q)}$	Unidirectional; $I_P = 0\text{ A}$	–	$V_{CC} \times 0.1$	–	V
<b>ACCURACY PERFORMANCE</b>						
Total Output Error [2]	$E_{TOT}$	$I_P = I_{PR(\max)}$ ; $T_A = 25^\circ\text{C}$ to $150^\circ\text{C}$	–2	$\pm 0.8$	2	%
		$I_P = I_{PR(\max)}$ ; $T_A = -40^\circ\text{C}$ to $25^\circ\text{C}$	–6	$\pm 4$	6	%
<b>TOTAL OUTPUT ERROR COMPONENTS [3] <math>E_{TOT} = E_{SENS} + 100 \times V_{OE}/(\text{Sens} \times I_P)</math></b>						
Sensitivity Error	$E_{sens}$	$I_P = I_{PR(\max)}$ ; $T_A = 25^\circ\text{C}$ to $150^\circ\text{C}$	–1.5	$\pm 0.8$	1.5	%
		$I_P = I_{PR(\max)}$ ; $T_A = -40^\circ\text{C}$ to $25^\circ\text{C}$	–5.5	$\pm 4$	5.5	%
Offset Voltage	$V_{OE}$	$I_P = 0\text{ A}$ ; $T_A = 25^\circ\text{C}$ to $150^\circ\text{C}$	–10	$\pm 4$	10	mV
		$I_P = 0\text{ A}$ ; $T_A = -40^\circ\text{C}$ to $25^\circ\text{C}$	–30	$\pm 5$	30	mV
<b>LIFETIME DRIFT CHARACTERISTICS</b>						
Sensitivity Error Lifetime Drift	$E_{sens\_drift}$		–3	$\pm 1$	3	%
Total Output Error Lifetime Drift	$E_{tot\_drift}$		–3	$\pm 1$	3	%

[1] Typical values with  $\pm$  are 3 sigma values

[2] Percentage of  $I_P$ , with  $I_P = I_{PR(\max)}$ .

[3] A single part will not have both the maximum/minimum sensitivity error and maximum/minimum offset voltage, as that would violate the maximum/minimum total output error specification. Also, 3 sigma distribution values are combined by taking the square root of the sum of the squares. See Application Information section.

**xLLCTR-20AB PERFORMANCE CHARACTERISTICS:**  $T_A$  Range L, valid at  $T_A = -40^\circ\text{C}$  to  $150^\circ\text{C}$ ,  $V_{CC} = 3.3\text{ V}$ , unless otherwise specified

Characteristic	Symbol	Test Conditions	Min.	Typ. [1]	Max.	Unit
<b>NOMINAL PERFORMANCE</b>						
Current Sensing Range	$I_{PR}$		-20	-	20	A
Sensitivity	Sens	$I_{PR(\min)} < I_P < I_{PR(\max)}$	-	66	-	mV/A
Zero Current Output Voltage	$V_{IOUT(Q)}$	Bidirectional; $I_P = 0\text{ A}$	-	$V_{CC} \times 0.5$	-	V
<b>ACCURACY PERFORMANCE</b>						
Total Output Error [2]	$E_{TOT}$	$I_P = I_{PR(\max)}$ ; $T_A = 25^\circ\text{C}$ to $150^\circ\text{C}$	-2	$\pm 0.8$	2	%
		$I_P = I_{PR(\max)}$ ; $T_A = -40^\circ\text{C}$ to $25^\circ\text{C}$	-6	$\pm 4$	6	%
<b>TOTAL OUTPUT ERROR COMPONENTS [3] <math>E_{TOT} = E_{SENS} + 100 \times V_{OE} / (\text{Sens} \times I_P)</math></b>						
Sensitivity Error	$E_{sens}$	$I_P = I_{PR(\max)}$ ; $T_A = 25^\circ\text{C}$ to $150^\circ\text{C}$	-1.5	$\pm 0.8$	1.5	%
		$I_P = I_{PR(\max)}$ ; $T_A = -40^\circ\text{C}$ to $25^\circ\text{C}$	-5.5	$\pm 4$	5.5	%
Offset Voltage	$V_{OE}$	$I_P = 0\text{ A}$ ; $T_A = 25^\circ\text{C}$ to $150^\circ\text{C}$	-10	$\pm 4$	10	mV
		$I_P = 0\text{ A}$ ; $T_A = -40^\circ\text{C}$ to $25^\circ\text{C}$	-30	$\pm 5$	30	mV
<b>LIFETIME DRIFT CHARACTERISTICS</b>						
Sensitivity Error Lifetime Drift	$E_{sens\_drift}$		-3	$\pm 1$	3	%
Total Output Error Lifetime Drift	$E_{tot\_drift}$		-3	$\pm 1$	3	%

[1] Typical values with  $\pm$  are 3 sigma values

[2] Percentage of  $I_P$ , with  $I_P = I_{PR(\max)}$ .

[3] A single part will not have both the maximum/minimum sensitivity error and maximum/minimum offset voltage, as that would violate the maximum/minimum total output error specification. Also, 3 sigma distribution values are combined by taking the square root of the sum of the squares. See Application Information section.

**xLLCTR-30AB PERFORMANCE CHARACTERISTICS:**  $T_A$  Range L, valid at  $T_A = -40^\circ\text{C}$  to  $150^\circ\text{C}$ ,  $V_{CC} = 3.3\text{ V}$ , unless otherwise specified

Characteristic	Symbol	Test Conditions	Min.	Typ. [1]	Max.	Unit
<b>NOMINAL PERFORMANCE</b>						
Current Sensing Range	$I_{PR}$		-30	-	30	A
Sensitivity	Sens	$I_{PR(\min)} < I_P < I_{PR(\max)}$	-	44	-	mV/A
Zero Current Output Voltage	$V_{IOUT(Q)}$	Bidirectional; $I_P = 0\text{ A}$	-	$V_{CC} \times 0.5$	-	V
<b>ACCURACY PERFORMANCE</b>						
Total Output Error [2]	$E_{TOT}$	$I_P = I_{PR(\max)}$ ; $T_A = 25^\circ\text{C}$ to $150^\circ\text{C}$	-2	$\pm 0.7$	2	%
		$I_P = I_{PR(\max)}$ ; $T_A = -40^\circ\text{C}$ to $25^\circ\text{C}$	-6	$\pm 4$	6	%
<b>TOTAL OUTPUT ERROR COMPONENTS [3] <math>E_{TOT} = E_{SENS} + 100 \times V_{OE} / (\text{Sens} \times I_P)</math></b>						
Sensitivity Error	$E_{sens}$	$I_P = I_{PR(\max)}$ ; $T_A = 25^\circ\text{C}$ to $150^\circ\text{C}$	-1.5	$\pm 0.7$	1.5	%
		$I_P = I_{PR(\max)}$ ; $T_A = -40^\circ\text{C}$ to $25^\circ\text{C}$	-5.5	$\pm 4$	5.5	%
Offset Voltage	$V_{OE}$	$I_P = 0\text{ A}$ ; $T_A = 25^\circ\text{C}$ to $150^\circ\text{C}$	-10	$\pm 3$	10	mV
		$I_P = 0\text{ A}$ ; $T_A = -40^\circ\text{C}$ to $25^\circ\text{C}$	-30	$\pm 5$	30	mV
<b>LIFETIME DRIFT CHARACTERISTICS</b>						
Sensitivity Error Lifetime Drift	$E_{sens\_drift}$		-3	$\pm 1$	3	%
Total Output Error Lifetime Drift	$E_{tot\_drift}$		-3	$\pm 1$	3	%

[1] Typical values with  $\pm$  are 3 sigma values

[2] Percentage of  $I_P$ , with  $I_P = I_{PR(\max)}$

[3] A single part will not have both the maximum/minimum sensitivity error and maximum/minimum offset voltage, as that would violate the maximum/minimum total output error specification. Also, 3 sigma distribution values are combined by taking the square root of the sum of the squares. See Application Information section.

**xLLCTR-30AB-H PERFORMANCE CHARACTERISTICS:**  $T_A$  Range L, valid at  $T_A = -40^\circ\text{C}$  to  $150^\circ\text{C}$ ,  $V_{CC} = 3.3\text{ V}$ , unless otherwise specified

Characteristic	Symbol	Test Conditions	Min.	Typ. [1]	Max.	Unit
<b>NOMINAL PERFORMANCE</b>						
Current Sensing Range	$I_{PR}$		-30	-	30	A
Sensitivity	Sens	$I_{PR(\min)} < I_P < I_{PR(\max)}$	-	44	-	mV/A
Zero Current Output Voltage	$V_{IOUT(Q)}$	Bidirectional; $I_P = 0\text{ A}$	-	$V_{CC} \times 0.5$	-	V
<b>ACCURACY PERFORMANCE</b>						
Total Output Error [2]	$E_{TOT}$	$I_P = I_{PR(\max)}$ ; $T_A = 25^\circ\text{C}$ to $150^\circ\text{C}$	-2	$\pm 0.7$	2	%
		$I_P = I_{PR(\max)}$ ; $T_A = -40^\circ\text{C}$ to $25^\circ\text{C}$	-2	$\pm 1.5$	2	%
<b>TOTAL OUTPUT ERROR COMPONENTS [3] <math>E_{TOT} = E_{SENS} + 100 \times V_{OE} / (\text{Sens} \times I_P)</math></b>						
Sensitivity Error	$E_{sens}$	$I_P = I_{PR(\max)}$ ; $T_A = 25^\circ\text{C}$ to $150^\circ\text{C}$	-1.5	$\pm 0.7$	1.5	%
		$I_P = I_{PR(\max)}$ ; $T_A = -40^\circ\text{C}$ to $25^\circ\text{C}$	-1.5	$\pm 1$	1.5	%
Offset Voltage	$V_{OE}$	$I_P = 0\text{ A}$ ; $T_A = 25^\circ\text{C}$ to $150^\circ\text{C}$	-10	$\pm 3$	10	mV
		$I_P = 0\text{ A}$ ; $T_A = -40^\circ\text{C}$ to $25^\circ\text{C}$	-10	$\pm 6$	10	mV
<b>LIFETIME DRIFT CHARACTERISTICS</b>						
Sensitivity Error Lifetime Drift	$E_{sens\_drift}$		-3	$\pm 1$	3	%
Total Output Error Lifetime Drift	$E_{tot\_drift}$		-3	$\pm 1$	3	%

[1] Typical values with  $\pm$  are 3 sigma values

[2] Percentage of  $I_P$ , with  $I_P = I_{PR(\max)}$

[3] A single part will not have both the maximum/minimum sensitivity error and maximum/minimum offset voltage, as that would violate the maximum/minimum total output error specification. Also, 3 sigma distribution values are combined by taking the square root of the sum of the squares. See Application Information section.

**xLLCTR-30AU PERFORMANCE CHARACTERISTICS:**  $T_A$  Range L, valid at  $T_A = -40^\circ\text{C}$  to  $150^\circ\text{C}$ ,  $V_{CC} = 3.3\text{ V}$ , unless otherwise specified

Characteristic	Symbol	Test Conditions	Min.	Typ. [1]	Max.	Unit
<b>NOMINAL PERFORMANCE</b>						
Current Sensing Range	$I_{PR}$		0	–	30	A
Sensitivity	Sens	$I_{PR(\min)} < I_P < I_{PR(\max)}$	–	88	–	mV/A
Zero Current Output Voltage	$V_{IOUT(Q)}$	Unidirectional; $I_P = 0\text{ A}$	–	$V_{CC} \times 0.1$	–	V
<b>ACCURACY PERFORMANCE</b>						
Total Output Error [2]	$E_{TOT}$	$I_P = I_{PR(\max)}$ ; $T_A = 25^\circ\text{C}$ to $150^\circ\text{C}$	–2	$\pm 0.8$	2	%
		$I_P = I_{PR(\max)}$ ; $T_A = -40^\circ\text{C}$ to $25^\circ\text{C}$	–6	$\pm 4$	6	%
<b>TOTAL OUTPUT ERROR COMPONENTS [3] <math>E_{TOT} = E_{SENS} + 100 \times V_{OE}/(\text{Sens} \times I_P)</math></b>						
Sensitivity Error	$E_{sens}$	$I_P = I_{PR(\max)}$ ; $T_A = 25^\circ\text{C}$ to $150^\circ\text{C}$	–1.5	$\pm 0.8$	1.5	%
		$I_P = I_{PR(\max)}$ ; $T_A = -40^\circ\text{C}$ to $25^\circ\text{C}$	–5.5	$\pm 4$	5.5	%
Offset Voltage	$V_{OE}$	$I_P = 0\text{ A}$ ; $T_A = 25^\circ\text{C}$ to $150^\circ\text{C}$	–10	$\pm 4$	10	mV
		$I_P = 0\text{ A}$ ; $T_A = -40^\circ\text{C}$ to $25^\circ\text{C}$	–30	$\pm 5$	30	mV
<b>LIFETIME DRIFT CHARACTERISTICS</b>						
Sensitivity Error Lifetime Drift	$E_{sens\_drift}$		–3	$\pm 1$	3	%
Total Output Error Lifetime Drift	$E_{tot\_drift}$		–3	$\pm 1$	3	%

[1] Typical values with  $\pm$  are 3 sigma values

[2] Percentage of  $I_P$ , with  $I_P = I_{PR(\max)}$ .

[3] A single part will not have both the maximum/minimum sensitivity error and maximum/minimum offset voltage, as that would violate the maximum/minimum total output error specification. Also, 3 sigma distribution values are combined by taking the square root of the sum of the squares. See Application Information section.

**xLLCTR-40AB PERFORMANCE CHARACTERISTICS:**  $T_A$  Range L, valid at  $T_A = -40^\circ\text{C}$  to  $150^\circ\text{C}$ ,  $V_{CC} = 3.3\text{ V}$ , unless otherwise specified

Characteristic	Symbol	Test Conditions	Min.	Typ. [1]	Max.	Unit
<b>NOMINAL PERFORMANCE</b>						
Current Sensing Range	$I_{PR}$		–40	–	40	A
Sensitivity	Sens	$I_{PR(\min)} < I_P < I_{PR(\max)}$	–	33	–	mV/A
Zero Current Output Voltage	$V_{IOUT(Q)}$	Bidirectional; $I_P = 0\text{ A}$	–	$V_{CC} \times 0.5$	–	V
<b>ACCURACY PERFORMANCE</b>						
Total Output Error [2]	$E_{TOT}$	$I_P = I_{PR(\max)}$ ; $T_A = 25^\circ\text{C}$ to $150^\circ\text{C}$	–2	$\pm 1$	2	%
		$I_P = I_{PR(\max)}$ ; $T_A = -40^\circ\text{C}$ to $25^\circ\text{C}$	–6	$\pm 4$	6	%
<b>TOTAL OUTPUT ERROR COMPONENTS [3] <math>E_{TOT} = E_{SENS} + 100 \times V_{OE}/(\text{Sens} \times I_P)</math></b>						
Sensitivity Error	$E_{sens}$	$I_P = I_{PR(\max)}$ ; $T_A = 25^\circ\text{C}$ to $150^\circ\text{C}$	–1.5	$\pm 1$	1.5	%
		$I_P = I_{PR(\max)}$ ; $T_A = -40^\circ\text{C}$ to $25^\circ\text{C}$	–5.5	$\pm 4$	5.5	%
Offset Voltage	$V_{OE}$	$I_P = 0\text{ A}$ ; $T_A = 25^\circ\text{C}$ to $150^\circ\text{C}$	–10	$\pm 3$	10	mV
		$I_P = 0\text{ A}$ ; $T_A = -40^\circ\text{C}$ to $25^\circ\text{C}$	–30	$\pm 5$	30	mV
<b>LIFETIME DRIFT CHARACTERISTICS</b>						
Sensitivity Error Lifetime Drift	$E_{sens\_drift}$		–3	$\pm 1$	3	%
Total Output Error Lifetime Drift	$E_{tot\_drift}$		–3	$\pm 1$	3	%

[1] Typical values with  $\pm$  are 3 sigma values

[2] Percentage of  $I_P$ , with  $I_P = I_{PR(\max)}$ .

[3] A single part will not have both the maximum/minimum sensitivity error and maximum/minimum offset voltage, as that would violate the maximum/minimum total output error specification. Also, 3 sigma distribution values are combined by taking the square root of the sum of the squares. See Application Information section.

**xLLCTR-50AB PERFORMANCE CHARACTERISTICS:**  $T_A$  Range L, valid at  $T_A = -40^\circ\text{C}$  to  $150^\circ\text{C}$ ,  $V_{CC} = 3.3\text{ V}$ , unless otherwise specified

Characteristic	Symbol	Test Conditions	Min.	Typ. [1]	Max.	Unit
<b>NOMINAL PERFORMANCE</b>						
Current Sensing Range	$I_{PR}$		-50	-	50	A
Sensitivity	Sens	$I_{PR(\min)} < I_P < I_{PR(\max)}$	-	26.4	-	mV/A
Zero Current Output Voltage	$V_{IOUT(Q)}$	Bidirectional; $I_P = 0\text{ A}$	-	$V_{CC} \times 0.5$	-	V
<b>ACCURACY PERFORMANCE</b>						
Total Output Error [2]	$E_{TOT}$	$I_P = I_{PR(\max)}$ ; $T_A = 25^\circ\text{C}$ to $150^\circ\text{C}$	-2	$\pm 1$	2	%
		$I_P = I_{PR(\max)}$ ; $T_A = -40^\circ\text{C}$ to $25^\circ\text{C}$	-6	$\pm 4$	6	%
<b>TOTAL OUTPUT ERROR COMPONENTS [3] <math>E_{TOT} = E_{SENS} + 100 \times V_{OE} / (\text{Sens} \times I_P)</math></b>						
Sensitivity Error	$E_{sens}$	$I_P = I_{PR(\max)}$ ; $T_A = 25^\circ\text{C}$ to $150^\circ\text{C}$	-1.5	$\pm 1$	1.5	%
		$I_P = I_{PR(\max)}$ ; $T_A = -40^\circ\text{C}$ to $25^\circ\text{C}$	-5.5	$\pm 4$	5.5	%
Offset Voltage	$V_{OE}$	$I_P = 0\text{ A}$ ; $T_A = 25^\circ\text{C}$ to $150^\circ\text{C}$	-10	$\pm 3$	10	mV
		$I_P = 0\text{ A}$ ; $T_A = -40^\circ\text{C}$ to $25^\circ\text{C}$	-30	$\pm 5$	30	mV
<b>LIFETIME DRIFT CHARACTERISTICS</b>						
Sensitivity Error Lifetime Drift	$E_{sens\_drift}$		-3	$\pm 1$	3	%
Total Output Error Lifetime Drift	$E_{tot\_drift}$		-3	$\pm 1$	3	%

[1] Typical values with  $\pm$  are 3 sigma values

[2] Percentage of  $I_P$ , with  $I_P = I_{PR(\max)}$ .

[3] A single part will not have both the maximum/minimum sensitivity error and maximum/minimum offset voltage, as that would violate the maximum/minimum total output error specification. Also, 3 sigma distribution values are combined by taking the square root of the sum of the squares. See Application Information section.

## CHARACTERISTIC PERFORMANCE ACS725 TYPICAL FREQUENCY RESPONSE

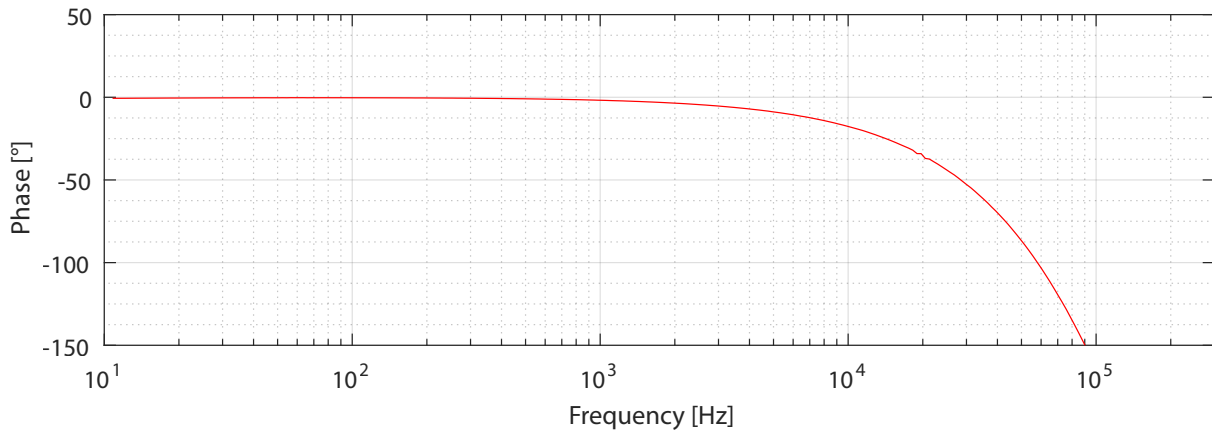
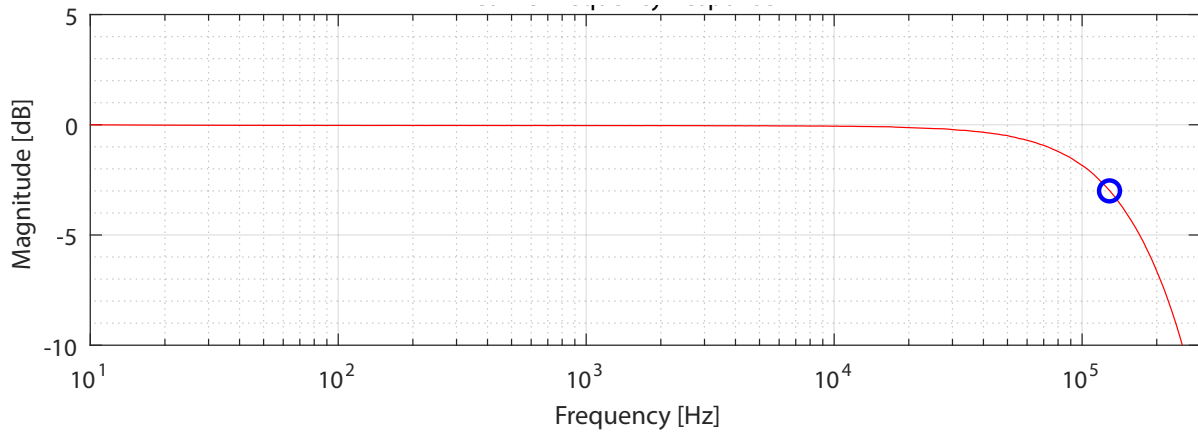

### APPLICATION INFORMATION

#### Estimating Total Error vs. Sensed Current

The Performance Characteristics tables give distribution ( $\pm 3$  sigma) values for Total Error at  $I_{PR(max)}$ ; however, one often wants to know what error to expect at a particular current. This can be estimated by using the distribution data for the components of Total Error, Sensitivity Error, and Offset Voltage. The  $\pm 3$  sigma value for Total Error ( $E_{TOT}$ ) as a function of the sensed current ( $I_p$ ) is estimated as:

$$E_{TOT}(I_p) = \sqrt{E_{SENS}^2 + \left(\frac{100 \times V_{OE}}{Sens \times I_p}\right)^2}$$

Here,  $E_{SENS}$  and  $V_{OE}$  are the  $\pm 3$  sigma values for those error terms. If there is an average sensitivity error or average offset voltage, then the average Total Error is estimated as:

$$E_{TOT_{AVG}}(I_p) = E_{SENS_{AVG}} + \frac{100 \times V_{OE_{AVG}}}{Sens \times I_p}$$

The resulting total error will be a sum of  $E_{TOT}$  and  $E_{TOT_{AVG}}$ . Using these equations and the 3 sigma distributions for Sensitivity Error and Offset Voltage, the Total Error vs. sensed current ( $I_p$ ) is below for the ACS725LLCTR-20AB. As expected, as one goes towards zero current, the error in percent goes towards infinity due to division by zero.

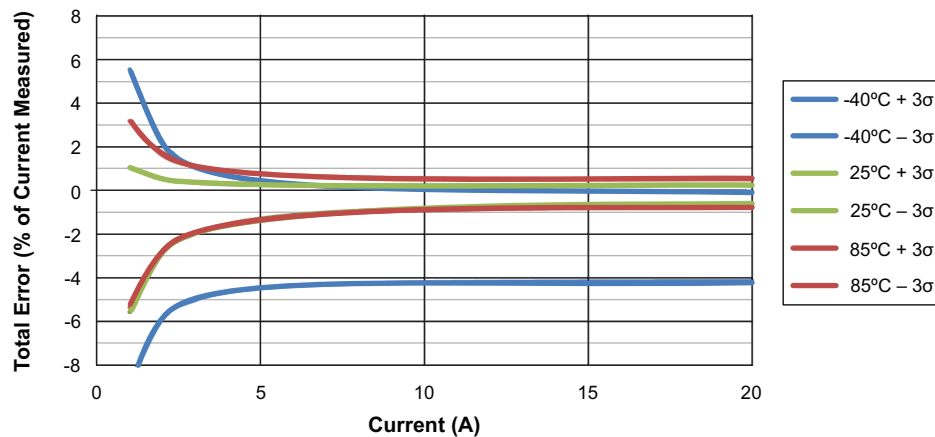

Figure 1: Predicted Total Error as a Function of the Sensed Current for the ACS725LLCTR-20AB

### Thermal Rise vs. Primary Current

Self-heating due to the flow-off current should be considered during the design of any current sensing system. The sensor, printed circuit board (PCB), and contacts to the PCB will generate heat as current moves through the system.

The thermal response is highly dependent on PCB layout, copper thickness, cooling techniques, and the profile of the injected current. The current profile includes peak current, current “on-time”, and duty cycle. While the data presented in this section was collected with direct current (DC), these numbers may be used to approximate thermal response for both AC signals and current pulses.

The plot in Figure 2 shows the measured rise in steady-state die temperature of the ACS725 versus DC input current at an ambient temperature,  $T_A$ , of 25 °C. The thermal offset curves may be directly applied to other values of  $T_A$ .

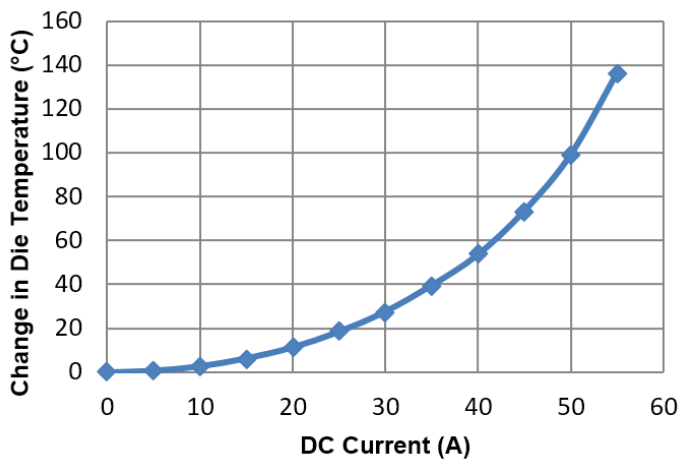
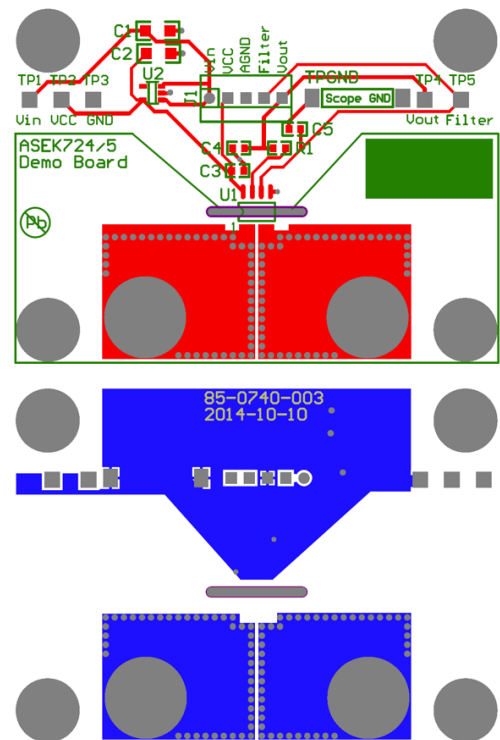

**Figure 2: Self Heating in the LA Package Due to Current Flow**

The thermal capacity of the ACS725 should be verified by the end user in the application’s specific conditions. The maximum junction temperature,  $T_{J(MAX)}$  (165°C), should not be exceeded. Further information on this application testing is available in the [DC and Transient Current Capability application note](#) on the Allegro website.

### ASEK724/5 Evaluation Board Layout

Thermal data shown in Figure 2 was collected using the ASEK724/5 Evaluation Board (TED-85-0740-003). This board includes 1500 mm<sup>2</sup> of 2 oz. copper (0.0694 mm) connected to pins 1 and 2, and to pins 3 and 4, with thermal vias connecting the layers. Top and bottom layers of the PCB are shown below in Figure 3.



**Figure 3: Top and Bottom Layers for ASEK724/5 Evaluation Board**

Gerber files for the ASEK724/5 evaluation board are available for download from our website. See the technical documents section of the [ACS725 device webpage](#).

### DEFINITIONS OF ACCURACY CHARACTERISTICS

**Sensitivity (Sens).** The change in sensor IC output in response to a 1 A change through the primary conductor. The sensitivity is the product of the magnetic circuit sensitivity (G/A) (1 G = 0.1 mT) and the linear IC amplifier gain (mV/G). The linear IC amplifier gain is programmed at the factory to optimize the sensitivity (mV/A) for the full-scale current of the device.

**Nonlinearity ( $E_{LIN}$ ).** The nonlinearity is a measure of how linear the output of the sensor IC is over the full current measurement range. The nonlinearity is calculated as:

$$E_{LIN} = \left\{ 1 - \left[ \frac{V_{IOUT}(I_{PR(max)}) - V_{IOUT(Q)}}{2 \cdot V_{IOUT}(I_{PR(max)/2}) - V_{IOUT(Q)}} \right] \right\} \cdot 100(\%)$$

where  $V_{IOUT}(I_{PR(max)})$  is the output of the sensor IC with the maximum measurement current flowing through it and  $V_{IOUT}(I_{PR(max)/2})$  is the output of the sensor IC with half of the maximum measurement current flowing through it.

**Zero Current Output Voltage ( $V_{IOUT(Q)}$ ).** The output of the sensor when the primary current is zero. For a unipolar supply voltage, it nominally remains at  $0.5 \times V_{CC}$  for a bidirectional device and  $0.1 \times V_{CC}$  for a unidirectional device. For example, in the case of a bidirectional output device,  $V_{CC} = 3.3$  V translates into  $V_{IOUT(Q)} = 1.65$  V. Variation in  $V_{IOUT(Q)}$  can be attributed to the resolution of the Allegro linear IC quiescent voltage trim and thermal drift.

**Offset Voltage ( $V_{OE}$ ).** The deviation of the device output from its ideal quiescent value of  $0.5 \times V_{CC}$  (bidirectional) or  $0.1 \times V_{CC}$  (unidirectional) due to nonmagnetic causes. To convert this voltage to amperes, divide by the device sensitivity, Sens.

**Total Output Error ( $E_{TOT}$ ).** The difference between the current measurement from the sensor IC and the actual current ( $I_P$ ), relative to the actual current. This is equivalent to the difference between the ideal output voltage and the actual output voltage, divided by the ideal sensitivity, relative to the current flowing through the primary conduction path:

$$E_{TOT}(I_P) = \frac{V_{IOUT,ideal}(I_P) - V_{IOUT}(I_P)}{Sens_{ideal}(I_P) \cdot I_P} \cdot 100(\%)$$

The Total Output Error incorporates all sources of error and is a function of  $I_P$ . At relatively high currents,  $E_{TOT}$  will be mostly due to sensitivity error, and at relatively low currents,  $E_{TOT}$  will be mostly due to Offset Voltage ( $V_{OE}$ ). In fact, at  $I_P = 0$ ,  $E_{TOT}$  approaches infinity due to the offset. This is illustrated in Figure 4 and Figure 5. Figure 4 shows a distribution of output voltages versus  $I_P$  at 25°C and across temperature. Figure 5 shows the corresponding  $E_{TOT}$  versus  $I_P$ .

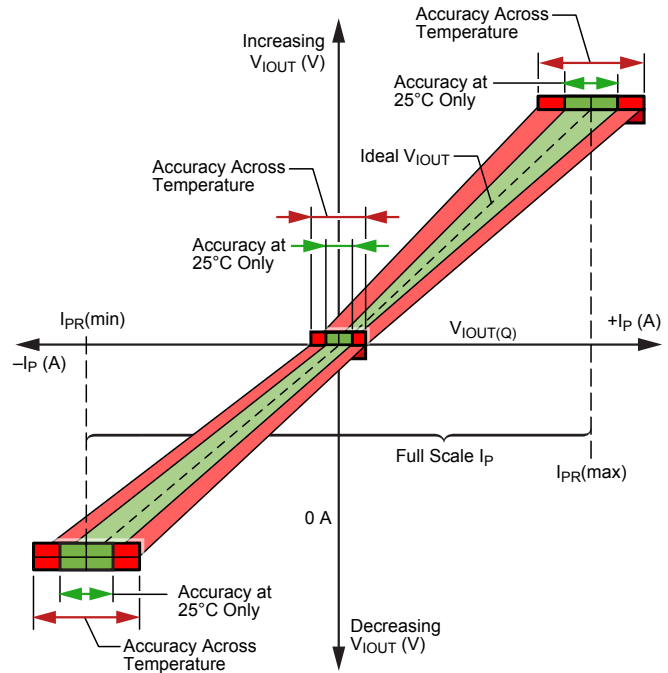

Figure 4: Output Voltage versus Sensed Current

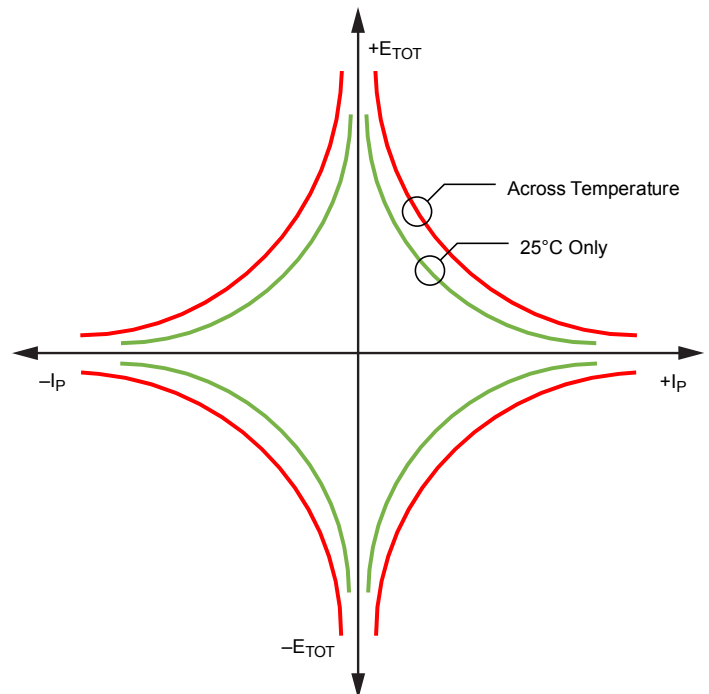

Figure 5: Total Output Error versus Sensed Current

**Sensitivity Ratiometry Coefficient (SENS\_RAT\_COEF).** The coefficient defining how the sensitivity scales with  $V_{CC}$ . The ideal coefficient is 1, meaning the sensitivity scales proportionally with  $V_{CC}$ . A 10% increase in  $V_{CC}$  results in a 10% increase in sensitivity. A coefficient of 1.1 means that the sensitivity increases by 10% more than the ideal proportionality case. This means that a 10% increase in  $V_{CC}$  results in an 11% increase in sensitivity. This relationship is described by the following equation:

$$Sens(V_{cc}) = Sens(3.3 V) \left[ 1 + \frac{(V_{cc} - 3.3 V) \cdot SENS\_RAT\_COEF}{3.3 V} \right]$$

This can be rearranged to define the sensitivity ratiometry coefficient as:

$$SENS\_RAT\_COEF = \left[ \frac{Sens(V_{cc})}{Sens(3.3 V)} - 1 \right] \cdot \frac{3.3 V}{(V_{cc} - 3.3 V)}$$

**Zero Current Output Ratiometry Coefficient (QVO\_RAT\_COEF).** The coefficient defining how the zero current output voltage scales with  $V_{CC}$ . The ideal coefficient is 1, meaning the output voltage scales proportionally with  $V_{CC}$ , always being equal to  $V_{CC}/2$ . A coefficient of 1.1 means that the zero current output voltage increases by 10% more than the ideal proportionality case. This means that a 10% increase in  $V_{CC}$  results in an 11% increase in the zero current output voltage. This relationship is described by the following equation:

$$VIOUTQ(V_{cc}) = VIOUTQ(3.3 V) \left[ 1 + \frac{(V_{cc} - 3.3 V) \cdot QVO\_RAT\_COEF}{3.3 V} \right]$$

This can be rearranged to define the zero current output ratiometry coefficient as:

$$QVO\_RAT\_COEF = \left[ \frac{VIOUTQ(V_{cc})}{VIOUTQ(3.3 V)} - 1 \right] \cdot \frac{3.3 V}{(V_{cc} - 3.3 V)}$$

### DEFINITIONS OF DYNAMIC RESPONSE CHARACTERISTICS

**Power-On Time ( $t_{PO}$ ).** When the supply is ramped to its operating voltage, the device requires a finite time to power its internal components before responding to an input magnetic field. Power-On Time,  $t_{PO}$ , is defined as the time it takes for the output voltage to settle within  $\pm 10\%$  of its steady state value under an applied magnetic field, after the power supply has reached its minimum specified operating voltage,  $V_{CC(min)}$ , as shown in the chart at right.

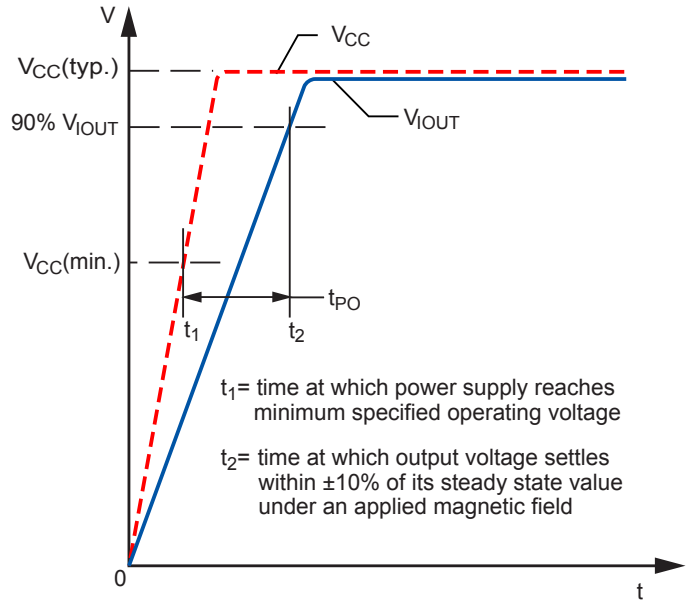

Figure 6: Power-On Time ( $t_{PO}$ )

**Rise Time ( $t_r$ ).** The time interval between a) when the sensor IC reaches 10% of its full scale value, and b) when it reaches 90% of its full scale value. The rise time to a step response is used to derive the bandwidth of the current sensor IC, in which  $f(-3 \text{ dB}) = 0.35/t_r$ . Both  $t_r$  and  $t_{RESPONSE}$  are detrimentally affected by eddy current losses observed in the conductive IC ground plane.

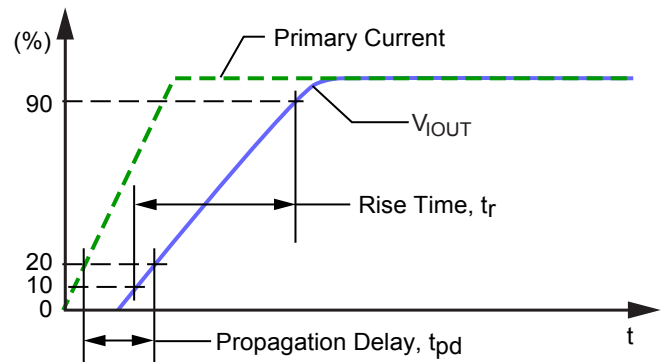

Figure 7: Rise Time ( $t_r$ ) and Propagation Delay ( $t_{pd}$ )

**Response Time ( $t_{RESPONSE}$ ).** The time interval between a) when the primary current signal reaches 90% of its final value, and b) when the device reaches 90% of its output corresponding to the applied current.

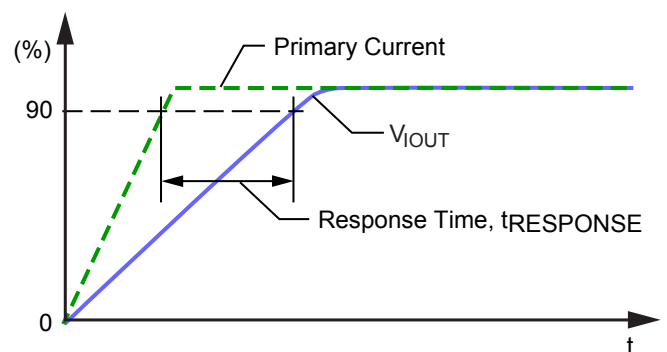

Figure 8: Response Time ( $t_{RESPONSE}$ )

### PACKAGE OUTLINE DRAWING

For Reference Only – Not for Tooling Use

(Reference MS-012AA)  
 Dimensions in millimeters – NOT TO SCALE  
 Dimensions exclusive of mold flash, gate burrs, and dambar protrusions  
 Exact case and lead configuration at supplier discretion within limits shown

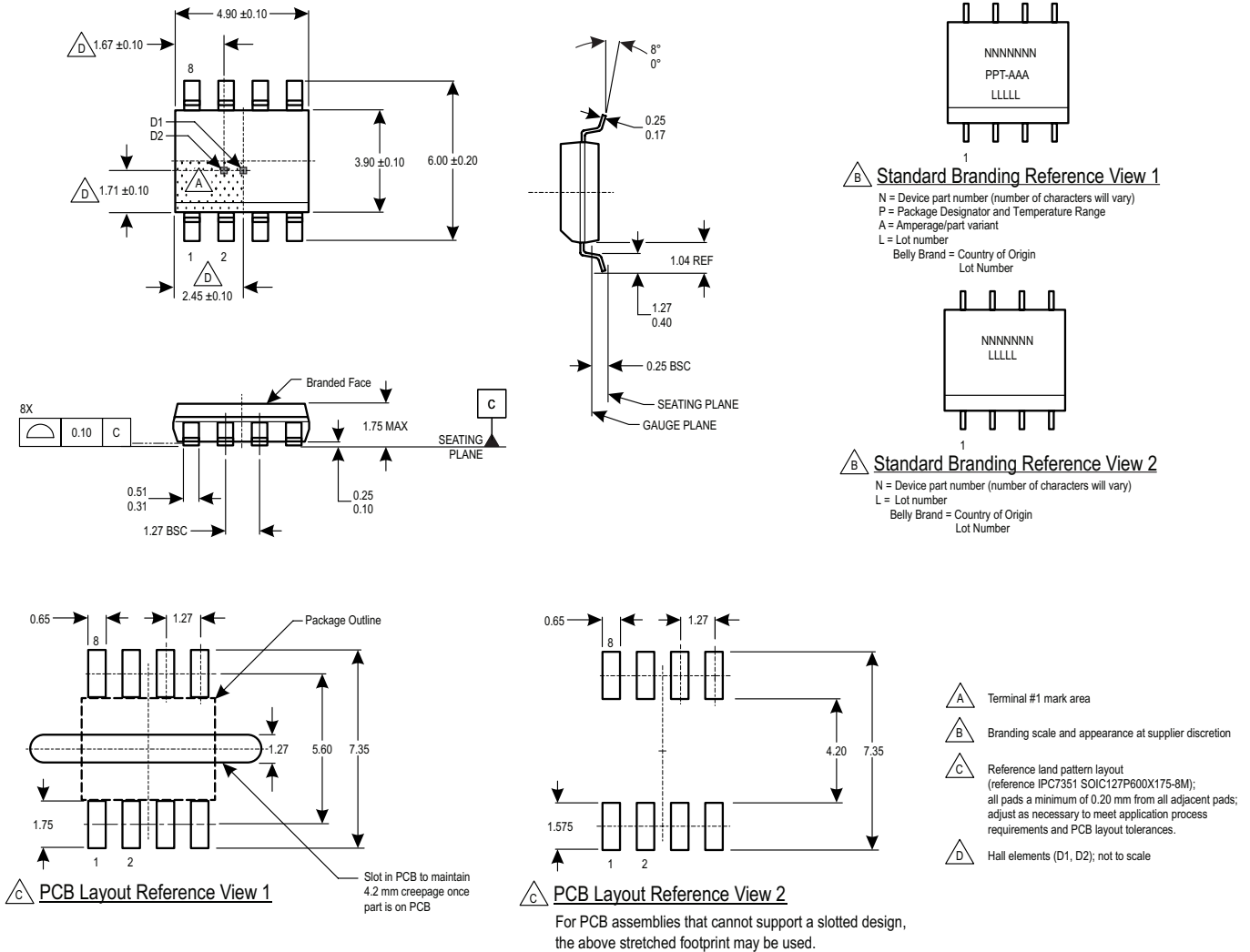

Figure 9: Package LC, 8-Pin SOICN

### Revision History

Number	Change	Pages	Responsible	Date
–	Initial Release	All	A. Latham	January 19, 2015
1	Added ACS725LLCTR-20AU-T to Selection Guide and Performance Characteristics charts, and corrected Sensitivity Error; added xLLCTR-20AU Characteristic Performance charts.	2, 6-8, 10	A. Latham	September 28, 2015
2	Added ACS725LLCTR-30AU-T to Selection Guide and Performance Characteristics charts.	2, 8	A. Latham	December 11, 2015
3	Added ACS725LLCTR-50AB-T to Selection Guide and Performance Characteristics charts.	2, 9	W. Bussing	March 17, 2017
4	Added AEC-Q100 qualified status	1	W. Bussing	June 28, 2017
5	Added ACS725LLCTR-05AB-T and ACS725LLCTR-10AB-T to Selection Guide and Performance Characteristics charts.	2, 5	M. McNally	November 15, 2017
6	Updated Clearance and Creepage rating values	3	W. Bussing	January 10, 2018
7	Added Dielectric Surge Strength Test Voltage characteristic	2	W. Bussing	January 23, 2018
	Added Common Mode Field Rejection Ratio characteristic	5		
8	Updated PCB Layout References in Package Outline Drawing	20	W. Bussing	March 19, 2018
9	Added Typical Frequency Response plots	16	W. Bussing	June 22, 2018
10	Added “Thermal Rise vs. Primary Current” and “ASEK724/5 Evaluation Board Layout” to the Applications Information section	18	W. Bussing	July 3, 2018
11	Added ACS725LLCTR-30AB-T-H to Selection Guide and Performance Characteristic charts.	2, 9, 15	M. McNally	July 30, 2018
12	Updated certificate numbers	1	V. Mach	December 13, 2018
13	Updated TUV certificate mark	1	M. McNally	June 3, 2019
14	Added ACS725LLC-20AB-T-H to Selection Guide and Performance Characteristics charts	2, 8	W. Bussing	December 20, 2019
	Removed Characteristic Plots	12-17		
15	Updated Functional Block Diagram	4	K. Hampton	February 1, 2021
16	Updated Comparative Tracking Index to Isolation Characteristics table	3	E. Shorman	July 7, 2021
17	Added -S lead-free part variants; removed ACS725LLCTR-20AB-T-H part variant; merged Selection Guides into one table and added footnote; minor editorial updates	1–4, 9	K. Hampton	May 16, 2022
18	Updated Branding Reference View	19	K. Hampton	July 7, 2023

Copyright 2023, Allegro MicroSystems.

Allegro MicroSystems reserves the right to make, from time to time, such departures from the detail specifications as may be required to permit improvements in the performance, reliability, or manufacturability of its products. Before placing an order, the user is cautioned to verify that the information being relied upon is current.

Allegro’s products are not to be used in any devices or systems, including but not limited to life support devices or systems, in which a failure of Allegro’s product can reasonably be expected to cause bodily harm.

The information included herein is believed to be accurate and reliable. However, Allegro MicroSystems assumes no responsibility for its use; nor for any infringement of patents or other rights of third parties which may result from its use.

Copies of this document are considered uncontrolled documents.

For the latest version of this document, visit our website:

[www.allegromicro.com](http://www.allegromicro.com)

## Looking for pricing, stock, or lifecycle information?

Click below to explore more details on WIN SOURCE:

- ⊖ [View ACS725LLCTR-30AB-T on WIN SOURCE](#)
- ⊖ [Allegro MicroSystems, LLC Information](#)

## Optimize Your Supply Chain with WIN SOURCE Solutions

- ✓ Global Sourcing Solution
- ✓ Obsolete Management
- ✓ Cost Control Management
- ✓ Shortage Management
- ✓ Alternative Solution
- ✓ Excess Inventory Management