



# THE DATASHEET OF ADM3222ARUZ



## ADM3202/ADM3222/ADM1385

### FEATURES

- 460 kbps data rate**
- Specified at 3.3 V**
- Meets EIA-232E specifications**
- 0.1  $\mu$ F charge pump capacitors**
- Low power shutdown (ADM3222 and ADM1385)**
- PDIP, SOIC\_N, SOIC\_W, SSOP, and TSSOP options**
- Upgrade for MAX3222/MAX3232 and LTC1385**
- ESD protection to IEC 1000-4-2 (801.2)**
  - on RS-232 pins (ADM3202 only)
- $\pm 8$  kV: contact discharge**
- $\pm 15$  kV: air gap discharge**

### APPLICATIONS

- General-purpose RS-232 data link**
- Portable instruments**
- Printers, palmtop computers, PDAs**

### GENERAL DESCRIPTION

The ADM3202/ADM3222/ADM1385 transceivers are high speed, 2-channel RS-232/V.28 interface devices that operate from a single 3.3 V power supply. Low power consumption and a shutdown facility (ADM3222/ADM1385) make them ideal for battery-powered portable instruments.

The ADM3202/ADM3222/ADM1385 parts conform to the EIA-232E and CCITT V.28 specifications and operate at data rates up to 460 kbps.

Four external 0.1  $\mu$ F charge pump capacitors are used for the voltage doubler/inverter, permitting operation from a single 3.3 V supply.

The ADM3222 contains additional enable and shutdown circuitry. The  $\overline{\text{EN}}$  input can be used to three-state the receiver outputs. The  $\overline{\text{SD}}$  input is used to power down the charge pump and transmitter outputs, reducing the quiescent current to less than 0.5  $\mu$ A. The receivers remain enabled during shutdown unless disabled using  $\overline{\text{EN}}$ .

The ADM1385 contains a driver disable mode and a complete shutdown mode.

The ADM3202 is available in a 16-lead PDIP, SOIC\_W, and SOIC\_N, as well as a space-saving 16-lead TSSOP. The ADM3222 is available in 18-lead PDIP and SOIC\_W and in 20-lead SSOP and TSSOP. The ADM1385 is available in a 20-lead SSOP, which is pin-compatible with the LTC1385 CG.

#### Rev. E

Information furnished by Analog Devices is believed to be accurate and reliable. However, no responsibility is assumed by Analog Devices for its use, nor for any infringements of patents or other rights of third parties that may result from its use. Specifications subject to change without notice. No license is granted by implication or otherwise under any patent or patent rights of Analog Devices. Trademarks and registered trademarks are the property of their respective owners.

### FUNCTIONAL BLOCK DIAGRAMS



Figure 1.



Figure 2.



Figure 3.

**TABLE OF CONTENTS**

Features .....	1	Pin Configurations (N, RN, RU, and RW Packages) .....	5
Applications.....	1	Pin Configurations (RS and RU Packages) .....	5
General Description .....	1	Typical Performance Characteristics .....	6
Functional Block Diagrams.....	1	General Description .....	8
Revision History .....	2	Circuit Description .....	8
Specifications.....	3	High Baud Rate.....	9
Absolute Maximum Ratings.....	4	Outline Dimensions .....	10
ESD Caution.....	4	Ordering Guide .....	14
Pin Configurations and Function Descriptions .....	5		

**REVISION HISTORY**

**7/11—Rev. D to Rev. E**

Changes to Figure 3.....	1
Changes to Table 2.....	4
Changes to Figure 17.....	8
Updated Outline Dimensions .....	10
Changes to Ordering Guide .....	14

**8/06—Rev. C to Rev. D**

Changes to Table 1.....	3
Updated Outline Dimensions .....	10
Changes to Ordering Guide .....	12

**9/05—Rev. B to Rev. C**

Updated Outline Dimensions .....	10
Changes to Ordering Guide .....	12

**12/01—Rev. A to Rev. B**

Changes to Specifications Page.....	2
-------------------------------------	---

## SPECIFICATIONS

$V_{CC} = 3.3 \text{ V} \pm 0.3 \text{ V}$ ,  $C1$  to  $C4 = 0.1 \mu\text{F}$ . All specifications  $T_{MIN}$  to  $T_{MAX}$ , unless otherwise noted.

Table 1.

Parameter	Min	Typ	Max	Unit	Test Conditions/Comments
<b>DC CHARACTERISTICS</b>					
Operating Voltage Range	3.0	3.3	5.5	V	
$V_{CC}$ Power Supply Current		1.3	3	mA	No load
		8	12	mA	$R_L = 3 \text{ k}\Omega$ to GND
Shutdown Supply Current		0.01	0.5	$\mu\text{A}$	
<b>LOGIC</b>					
Input Logic Threshold Low, $V_{INL}$			0.8	V	$T_{IN}$
Input Logic Threshold High, $V_{INH}$	2.0			V	$T_{IN}$
CMOS Output Voltage Low, $V_{OL}$			0.4	V	$I_{OUT} = 1.6 \text{ mA}$
CMOS Output Voltage High, $V_{OH}$	$V_{CC} - 0.6$			V	$I_{OUT} = -1 \text{ mA}$
Logic Pull-Up Current		5	10	$\mu\text{A}$	$T_{IN} = \text{GND to } V_{CC}^1$
Output Leakage Current			$\pm 10$	$\mu\text{A}$	Receivers disabled
<b>RS-232 RECEIVER</b>					
EIA-232 Input Voltage Range	-30		+30	V	
EIA-232 Input Threshold Low	0.6	1.2		V	
EIA-232 Input Threshold High		1.6	2.4	V	
EIA-232 Input Hysteresis		0.4		V	
EIA-232 Input Resistance	3	5	7	k $\Omega$	
<b>RS-232 TRANSMITTER</b>					
Output Voltage Swing (RS-232)	$\pm 5.0$	$\pm 5.2$		V	$V_{CC} = 3.3 \text{ V}$ , all transmitter outputs loaded with $3 \text{ k}\Omega$ to ground
Output Voltage Swing (RS-562)	$\pm 3.7$			V	$V_{CC} = 3.0 \text{ V}$
Transmitter Output Resistance	300			$\Omega$	$V_{CC} = 0 \text{ V}$ , $V_{OUT} = \pm 2 \text{ V}$
RS-232 Output Short-Circuit Current		$\pm 15$		mA	
Output Leakage Current			$\pm 25$	$\mu\text{A}$	$\overline{SD} = \text{low}$ , $V_{OUT} = 12 \text{ V}$
<b>TIMING CHARACTERISTICS</b>					
Maximum Data Rate	460			kbps	$V_{CC} = 3.3 \text{ V}$ , $R_L = 3 \text{ k}\Omega$ to $7 \text{ k}\Omega$ , $C_L = 50 \text{ pF}$ to $1000 \text{ pF}$ , one Tx switching
Receiver Propagation Delay					
TPHL		0.4	1	$\mu\text{s}$	
TPLH		0.4	1	$\mu\text{s}$	
Transmitter Propagation Delay		0.3	1.2	$\mu\text{s}$	$R_L = 3 \text{ k}\Omega$ , $C_L = 1000 \text{ pF}$
Receiver Output Enable Time		200		ns	
Receiver Output Disable Time		200		ns	
Transmitter Skew		30		ns	
Receiver Skew		300		ns	
Transition Region Slew Rate	5.5	10	30	V/ $\mu\text{s}$	Measured from $+3 \text{ V}$ to $-3 \text{ V}$ or $-3 \text{ V}$ to $+3 \text{ V}$ , $V_{CC} = +3.3 \text{ V}$ ; $R_L = 3 \text{ k}\Omega$ , $C_L = 1000 \text{ pF}$ , $T_A = 25^\circ\text{C}$

<sup>1</sup> ADM1385: Input leakage current typically  $-10 \mu\text{A}$  when  $T_{IN} = \text{GND}$ .

## ABSOLUTE MAXIMUM RATINGS

T<sub>A</sub> = 25°C, unless otherwise noted.

Table 2.

Parameter	Rating
V <sub>CC</sub>	−0.3 V to +6 V
V+	(V <sub>CC</sub> − 0.3 V) to +14 V
V−	+0.3 V to −14 V
Input Voltages	
T <sub>IN</sub>	−0.3 V to (V+, +0.3 V)
R <sub>IN</sub>	±30 V
Output Voltages	
T <sub>OUT</sub>	±15 V
R <sub>OUT</sub>	−0.3 V to (V <sub>CC</sub> + 0.3 V)
Short-Circuit Duration	
T <sub>OUT</sub>	Continuous
Power Dissipation (Derates 6 mW/°C above 50°C)	450 mW
Thermal Impedance, θ <sub>JA</sub>	
N-16/N-18 (2-Layer Test Board)	117°C/W
RW-16/RW-18 (4-Layer Test Board)	56°C/W
R-16 (4-Layer Test Board)	81°C/W
RU-16 (4-Layer Test Board)	113°C/W
RU-20 (4-Layer Test Board)	110°C/W
RS-20 (4-Layer Test Board)	83°C/W
Operating Temperature Range	
Industrial (A Version)	−40°C to +85°C
Storage Temperature Range	−65°C to +150°C
Lead Temperature (Soldering, 10 sec)	JEDEC industry standard J-STD-020

Stresses above those listed under Absolute Maximum Ratings may cause permanent damage to the device. This is a stress rating only; functional operation of the device at these or any other conditions above those indicated in the operational section of this specification is not implied. Exposure to absolute maximum rating conditions for extended periods may affect device reliability.

### ESD CAUTION



#### ESD (electrostatic discharge) sensitive device.

Charged devices and circuit boards can discharge without detection. Although this product features patented or proprietary protection circuitry, damage may occur on devices subjected to high energy ESD. Therefore, proper ESD precautions should be taken to avoid performance degradation or loss of functionality.

# PIN CONFIGURATIONS AND FUNCTION DESCRIPTIONS

## PIN CONFIGURATIONS (N, R, RU, AND RW PACKAGES)



Figure 4. N, R, RU, and RW Packages Pin Configuration



Figure 5. N and RW Packages Pin Configuration

## PIN CONFIGURATIONS (RS AND RU PACKAGES)



Figure 6. RS and RU Packages Pin Configuration



Figure 7. RS Package Pin Configuration

Table 3. Pin Function Descriptions

Mnemonic	Description
V <sub>CC</sub>	Power Supply Input (3.3 V ± 0.3 V).
V+	Internally Generated Positive Supply (+6 V nominal).
V-	Internally Generated Negative Supply (-6 V nominal).
GND	Ground Pin. Must be connected to 0 V.
C1+, C1-	External Capacitor 1 is connected between these pins. A 0.1 μF capacitor is recommended but larger capacitors up to 47 μF can be used.
C2+, C2-	External Capacitor 2 is connected between these pins. A 0.1 μF capacitor is recommended but larger capacitors up to 47 μF can be used.
T <sub>XIN</sub>	Transmitter (Driver) Inputs. These inputs accept TTL/CMOS levels.
T <sub>XOUT</sub>	Transmitter (Driver) Outputs. These are RS-232 signal levels (typically ±9 V).
R <sub>XIN</sub>	Receiver Inputs. These inputs accept RS-232 signal levels. An internal 5 kΩ pull-down resistor to GND is connected on each input.
R <sub>XOUT</sub>	Receiver Outputs. These are CMOS output logic levels.
EN	(ADM3222 only) Receiver Enable. Active low. When low, the receiver outputs are enabled. When high, they are three-stated.
SD	(ADM3222 only) Shutdown Control. Active low. When low, the charge pump is shut down and the transmitter outputs are disabled.
SD	(ADM1385 only) Shutdown Control. When low, the charge pump is shut down and all transmitters and receivers are disabled.
DD	(ADM1385 only) Driver Disable. When low, the charge pump is turned off and the transmitters are disabled. The receivers remain active.
NC	No Connect.

## TYPICAL PERFORMANCE CHARACTERISTICS



Figure 8. Transmitter Output Voltage High/Low vs. Load Capacitance @ 460 kbps

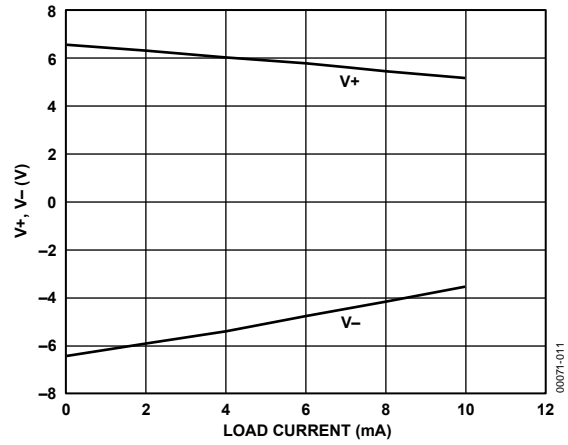

Figure 11. Charge Pump V+, V- vs. Load Current



Figure 9. Transmitter Output Voltage vs. V<sub>CC</sub>

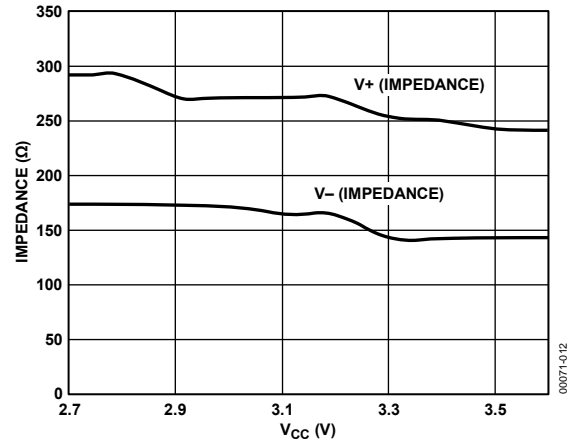

Figure 12. Charge Pump Impedance vs. V<sub>CC</sub>



Figure 10. Transmitter Output Voltage Low/High vs. Load Current

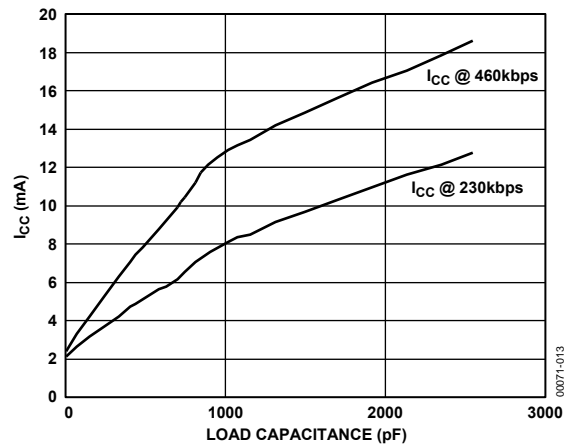

Figure 13. Power Supply Current vs. Load Capacitance

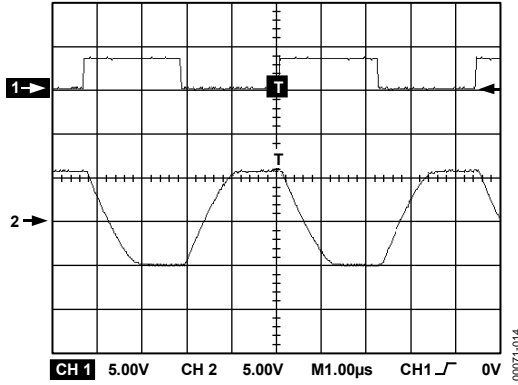

Figure 14. 460 kbps Data Transmission

# ADM3202/ADM3222/ADM1385

## GENERAL DESCRIPTION

The ADM3202/ADM3222/ADM1385 are RS-232 line drivers/receivers. Step-up voltage converters coupled with level-shifting transmitters and receivers allow RS-232 levels to be developed while operating from a single 3.3 V supply.

CMOS technology is used to keep the power dissipation to an absolute minimum, allowing maximum battery life in portable applications.

The ADM3202/ADM3222/ADM1385 are modifications, enhancements, and improvements of the AD230 to AD241 family and derivatives. They are essentially plug-in compatible and do not have any materially different applications.

## CIRCUIT DESCRIPTION

The internal circuitry consists of these main sections:

- A charge pump voltage converter
- 3.3 V logic to EIA-232 transmitters
- EIA-232 to 5 V logic receivers

### Charge Pump DC to DC Voltage Converter

The charge pump voltage converter consists of a 200 kHz oscillator and a switching matrix. The converter generates a  $\pm 6.6$  V supply from the input 3.3 V level. This is done in two stages by using a switched capacitor technique as illustrated in Figure 18 and Figure 19. First, the 3.3 V input supply is doubled to 6.6 V by using Capacitor C1 as the charge storage element. The +6.6 V level is then inverted to generate  $-6.6$  V using C2 as the storage element. C3 is shown connected between V+ and V<sub>CC</sub> but is equally effective if connected between V+ and GND.

Capacitors C3 and C4 are used to reduce the output ripple. Their values are not critical and can be increased, if desired. Capacitor C3 is shown connected between V+ and V<sub>CC</sub>. It is also acceptable to connect this capacitor between V+ and GND.

If desired, larger capacitors (up to 10  $\mu$ F) can be used for capacitors C1 to C4.



Figure 16. ADM3222 Typical Operating Circuit



Figure 17. ADM1385 Typical Operating Circuit



Figure 18. Charge Pump Voltage Doubler

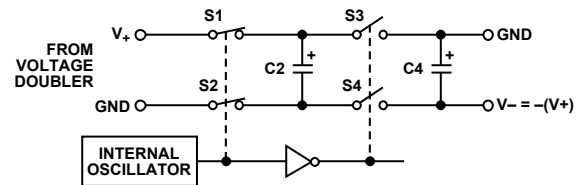

Figure 19. Charge Pump Voltage Inverter



Figure 15. ADM3202 Typical Operating Circuit

***Transmitter (Driver) Section***

The drivers convert 3.3 V logic input levels into RS-232 output levels. With  $V_{CC} = 3.3$  V and driving an RS-232 load, the output voltage swing is typically  $\pm 6$  V.

***Receiver Section***

The receivers are inverting level-shifters that accept RS-232 input levels and translate them into 3 V logic output levels. The inputs have internal 5 k $\Omega$ , pull-down resistors to ground and are protected against overvoltages up to  $\pm 30$  V. Unconnected inputs are pulled to 0 V by the internal 5 k $\Omega$ , pull-down resistor. This results in a Logic 1 output level for unconnected inputs or for inputs connected to GND.

The receivers have Schmitt-trigger inputs with a hysteresis level of 0.4 V. This ensures error-free reception for both noisy inputs and for inputs with slow transition times.

**HIGH BAUD RATE**

The ADM3202/ADM3222 feature high slew rates permitting data transmission at rates well in excess of the EIA/RS-232E specifications. RS-232 voltage levels are maintained at data rates up to 460 kbps even under worst-case loading conditions. This allows high speed data links between two terminals and is suitable for the new generation ISDN modem standards that require data rates of 230 kbps. The slew rate is internally controlled to less than 30 V/ $\mu$ s to minimize EMI interference.

OUTLINE DIMENSIONS



COMPLIANT TO JEDEC STANDARDS MS-001-AB  
 CONTROLLING DIMENSIONS ARE IN INCHES; MILLIMETER DIMENSIONS  
 (IN PARENTHESES) ARE ROUNDED-OFF INCH EQUIVALENTS FOR  
 REFERENCE ONLY AND ARE NOT APPROPRIATE FOR USE IN DESIGN.  
 CORNER LEADS MAY BE CONFIGURED AS WHOLE OR HALF LEADS.

Figure 20. 16-Lead Plastic Dual In-Line Package [PDIP]  
 Narrow Body  
 (N-16)  
 Dimensions shown in inches and (millimeters)

073106-B



COMPLIANT TO JEDEC STANDARDS MS-012-AC  
 CONTROLLING DIMENSIONS ARE IN MILLIMETERS; INCH DIMENSIONS  
 (IN PARENTHESES) ARE ROUNDED-OFF MILLIMETER EQUIVALENTS FOR  
 REFERENCE ONLY AND ARE NOT APPROPRIATE FOR USE IN DESIGN.

Figure 21. 16-Lead Standard Small Outline Package [SOIC\_N]  
 Narrow Body  
 (R-16)  
 Dimensions shown in millimeters and (inches)

069606-A

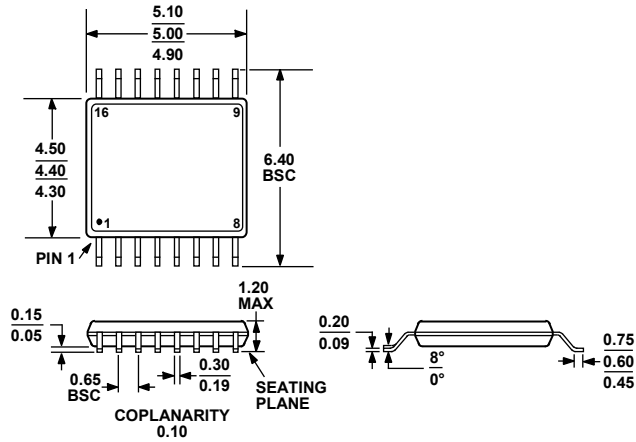

COMPLIANT TO JEDEC STANDARDS MO-153-AB

Figure 22. 16-Lead Thin Shrink Small Outline Package [TSSOP] (RU-16)

Dimensions shown in millimeters

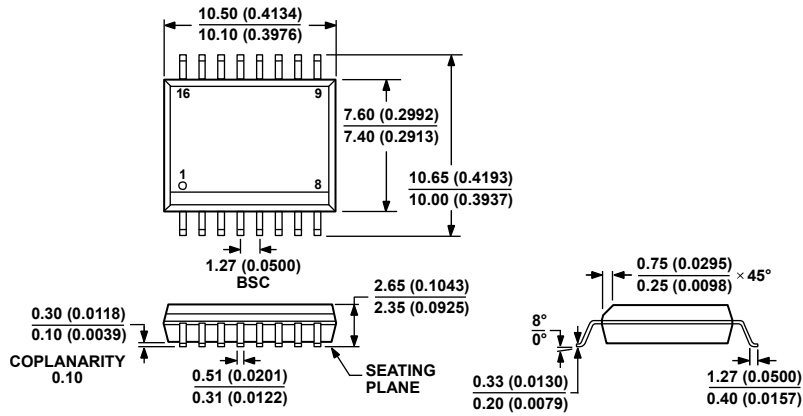

COMPLIANT TO JEDEC STANDARDS MS-013-AA  
CONTROLLING DIMENSIONS ARE IN MILLIMETERS; INCH DIMENSIONS (IN PARENTHESES) ARE ROUNDED-OFF MILLIMETER EQUIVALENTS FOR REFERENCE ONLY AND ARE NOT APPROPRIATE FOR USE IN DESIGN.

Figure 23. 16-Lead Standard Small Outline Package [SOIC\_W] Wide Body (RW-16)

Dimensions shown in millimeters and (inches)

03-27-2007-B

# ADM3202/ADM3222/ADM1385



COMPLIANT TO JEDEC STANDARDS MS-001

CONTROLLING DIMENSIONS ARE IN INCHES; MILLIMETER DIMENSIONS (IN PARENTHESES) ARE ROUNDED-OFF INCH EQUIVALENTS FOR REFERENCE ONLY AND ARE NOT APPROPRIATE FOR USE IN DESIGN. CORNER LEADS MAY BE CONFIGURED AS WHOLE OR HALF LEADS.

Figure 24. 18-Lead Plastic Dual In-Line Package [PDIP]  
Narrow Body  
(N-18)

Dimensions shown in inches and (millimeters)

070706-A



COMPLIANT TO JEDEC STANDARDS MO-150-AE

Figure 25. 20-Lead Shrink Small Outline Package [SSOP]  
(RS-20)

Dimensions shown in millimeters

060106-A



COMPLIANT TO JEDEC STANDARDS MO-153-AC

Figure 26. 20-Lead Thin Shrink Small Outline Package [TSSOP] (RU-20)

Dimensions shown in millimeters



COMPLIANT TO JEDEC STANDARDS MS-013-AB  
 CONTROLLING DIMENSIONS ARE IN MILLIMETERS; INCH DIMENSIONS (IN PARENTHESES) ARE ROUNDED-OFF MILLIMETER EQUIVALENTS FOR REFERENCE ONLY AND ARE NOT APPROPRIATE FOR USE IN DESIGN.

Figure 27. 18-Lead Standard Small Outline Package [SOIC\_W] Wide Body (RW-18)

Dimensions shown in millimeters and (inches)

068706-A

# ADM3202/ADM3222/ADM1385

## ORDERING GUIDE

Model <sup>1</sup>	Temperature Range	Package Description	Package Option
ADM3202AN	-40°C to +85°C	16-Lead Plastic Dual In-Line Package [PDIP]	N-16
ADM3202ANZ	-40°C to +85°C	16-Lead Plastic Dual In-Line Package [PDIP]	N-16
ADM3202ARN	-40°C to +85°C	16-Lead Standard Small Outline Package [SOIC_N]	R-16
ADM3202ARN-REEL	-40°C to +85°C	16-Lead Standard Small Outline Package [SOIC_N]	R-16
ADM3202ARN-REEL7	-40°C to +85°C	16-Lead Standard Small Outline Package [SOIC_N]	R-16
ADM3202ARNZ	-40°C to +85°C	16-Lead Standard Small Outline Package [SOIC_N]	R-16
ADM3202ARNZ-REEL	-40°C to +85°C	16-Lead Standard Small Outline Package [SOIC_N]	R-16
ADM3202ARNZ-REEL7	-40°C to +85°C	16-Lead Standard Small Outline Package [SOIC_N]	R-16
ADM3202ARU	-40°C to +85°C	16-Lead Thin Shrink Small Outline Package [TSSOP]	RU-16
ADM3202ARU-REEL	-40°C to +85°C	16-Lead Thin Shrink Small Outline Package [TSSOP]	RU-16
ADM3202ARU-REEL7	-40°C to +85°C	16-Lead Thin Shrink Small Outline Package [TSSOP]	RU-16
ADM3202ARUZ	-40°C to +85°C	16-Lead Thin Shrink Small Outline Package [TSSOP]	RU-16
ADM3202ARUZ-REEL	-40°C to +85°C	16-Lead Thin Shrink Small Outline Package [TSSOP]	RU-16
ADM3202ARUZ-REEL7	-40°C to +85°C	16-Lead Thin Shrink Small Outline Package [TSSOP]	RU-16
ADM3202ARW	-40°C to +85°C	16-Lead Standard Small Outline Package [SOIC_W]	RW-16
ADM3202ARW-REEL	-40°C to +85°C	16-Lead Standard Small Outline Package [SOIC_W]	RW-16
ADM3202ARWZ	-40°C to +85°C	16-Lead Standard Small Outline Package [SOIC_W]	RW-16
ADM3202ARWZ-REEL	-40°C to +85°C	16-Lead Standard Small Outline Package [SOIC_W]	RW-16
ADM3202ARWZ-REEL7	-40°C to +85°C	16-Lead Standard Small Outline Package [SOIC_W]	RW-16
ADM3222AN	-40°C to +85°C	18-Lead Plastic Dual In-Line Package [PDIP]	N-18
ADM3222ANZ	-40°C to +85°C	18-Lead Plastic Dual In-Line Package [PDIP]	N-18
ADM3222ARS	-40°C to +85°C	20-Lead Shrink Small Outline Package [SSOP]	RS-20
ADM3222ARS-REEL	-40°C to +85°C	20-Lead Shrink Small Outline Package [SSOP]	RS-20
ADM3222ARS-REEL7	-40°C to +85°C	20-Lead Shrink Small Outline Package [SSOP]	RS-20
ADM3222ARSZ	-40°C to +85°C	20-Lead Shrink Small Outline Package [SSOP]	RS-20
ADM3222ARSZ-REEL	-40°C to +85°C	20-Lead Shrink Small Outline Package [SSOP]	RS-20
ADM3222ARSZ-REEL7	-40°C to +85°C	20-Lead Shrink Small Outline Package [SSOP]	RS-20
ADM3222ARU	-40°C to +85°C	20-Lead Thin Shrink Small Outline Package [TSSOP]	RU-20
ADM3222ARU-REEL	-40°C to +85°C	20-Lead Thin Shrink Small Outline Package [TSSOP]	RU-20
ADM3222ARU-REEL7	-40°C to +85°C	20-Lead Thin Shrink Small Outline Package [TSSOP]	RU-20
ADM3222ARUZ	-40°C to +85°C	20-Lead Thin Shrink Small Outline Package [TSSOP]	RU-20
ADM3222ARUZ-REEL	-40°C to +85°C	20-Lead Thin Shrink Small Outline Package [TSSOP]	RU-20
ADM3222ARUZ-REEL7	-40°C to +85°C	20-Lead Thin Shrink Small Outline Package [TSSOP]	RU-20
ADM3222ARW	-40°C to +85°C	18-Lead Standard Small Outline Package [SOIC_W]	RW-18
ADM3222ARW-REEL	-40°C to +85°C	18-Lead Standard Small Outline Package [SOIC_W]	RW-18
ADM3222ARWZ	-40°C to +85°C	18-Lead Standard Small Outline Package [SOIC_W]	RW-18
ADM3222ARWZ-REEL	-40°C to +85°C	18-Lead Standard Small Outline Package [SOIC_W]	RW-18
ADM3222ARWZ-REEL7	-40°C to +85°C	18-Lead Standard Small Outline Package [SOIC_W]	RW-18
ADM1385ARS	-40°C to +85°C	20-Lead Shrink Small Outline Package [SSOP]	RS-20
ADM1385ARSZ	-40°C to +85°C	20-Lead Shrink Small Outline Package [SSOP]	RS-20
ADM1385ARSZ-REEL	-40°C to +85°C	20-Lead Shrink Small Outline Package [SSOP]	RS-20
ADM1385ARSZ-REEL7	-40°C to +85°C	20-Lead Shrink Small Outline Package [SSOP]	RS-20

<sup>1</sup> Z = RoHS Compliant Part.

**NOTES**

**NOTES**

## Looking for pricing, stock, or lifecycle information?

Click below to explore more details on WIN SOURCE:

 [View ADM3222ARUZ on WIN SOURCE](#)

 [Analog Devices Inc. Information](#)

## Optimize Your Supply Chain with WIN SOURCE Solutions

-  Global Sourcing Solution
-  Obsolete Management
-  Cost Control Management
-  Shortage Management
-  Alternative Solution
-  Excess Inventory Management