

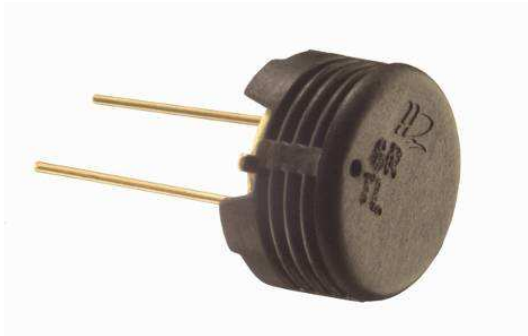

**THE DATASHEET OF
HPP801A031**



HS1101LF – Relative Humidity Sensor



- Lead free component
- High reliability and long term stability
- Patented solid polymer structure
- Suitable for linear voltage or frequency output circuitry
- Fast response time and very low temperature coefficient

DESCRIPTION

Based on a unique capacitive cell, these relative humidity sensors are designed for high volume, cost sensitive applications such as **office automation, automotive cabin air control, home appliances, and industrial process control systems**. They are also useful in all applications where humidity compensation is needed.

FEATURES

- Full interchangeability with no calibration required in standard conditions
- Instantaneous desaturation after long periods in saturation phase
- Compatible with automatized assembly processes, including Pb free wave soldering and reflow processes ⁽¹⁾
- Individual marking for compliance to stringent traceability requirements
- Part may be washed with distilled water

APPLICATIONS

- Automotive
- Home Appliance
- Printers
- Meteorology

PERFORMANCE SPECS

MAXIMUM RATINGS

Ratings	Symbol	Value	Unit
Operating Temperature	Ta	-60 to 140	°C
Storage Temperature	Tstg	-60 to 140	°C
Supply Voltage (Peak)	Vs	10	Vac
Humidity Operating Range	RH	0 to 100	% RH

Peak conditions: less than 10% of the operating time.

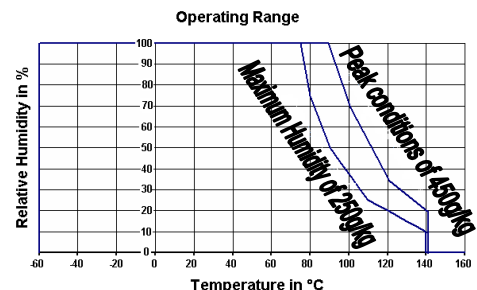

HS1101LF – Relative Humidity Sensor



ELECTRICAL CHARACTERISTICS OF HUMIDITY SENSOR

(Ta=25°C, measurement frequency @10kHz / 1V unless otherwise noted)

Characteristics	Symbol	Min	Typ	Max	Unit
Humidity Measuring Range	RH	1		99	%RH
Supply Voltage	Vs			10	V
Nominal capacitance @55%RH ⁽¹⁾	C	177	180	183	pF
Temperature coefficient	T _{cc}		-0.01		pF/°C
Average Sensitivity from 33% to 75%RH	ΔC/%RH		0.31		pF/%RH
Leakage Current (V _{cc} =5V)	I			1	nA
Recovery time after 150 hours of condensation	tr		10		s
Humidity Hysteresis				+/-1	%RH
Long term stability	T		+/-0.5		%RH/yr
Time Constant (at 63% of signal, still air) 33%RH to 80%RH	ta		3	5	s
Deviation to typical response curve (10% RH to 90%RH)			+/-2		%RH

(1) Tighter specification available on request

TYPICAL PERFORMANCE CURVES

POLYNOMIAL RESPONSE OF HS1101LF

$$C \text{ (pF)} = C@55\% * (3.903 \cdot 10^{-8} * RH^3 - 8.294 \cdot 10^{-6} * RH^2 + 2.188 \cdot 10^{-3} * RH + 0.898)$$

TYPICAL RESPONSE LOOK-UP TABLE (POLYNOMIAL REFERENCE CURVE) @ 10KHZ / 1V

RH (%)	0	5	10	15	20	25	30	35	40	45	50
Cp (pF)	161.6	163.6	165.4	167.2	169.0	170.7	172.3	173.9	175.5	177.0	178.5
RH (%)	55	60	65	70	75	80	85	90	95	100	
Cp (pF)	180	181.4	182.9	184.3	185.7	187.2	188.6	190.1	191.6	193.1	

REVERSE POLYNOMIAL RESPONSE OF HS1101LF

$$RH \text{ (%) } = -3.4656 \cdot 10^{+3} * X^3 + 1.0732 \cdot 10^{+4} * X^2 - 1.0457 \cdot 10^{+4} * X + 3.2459 \cdot 10^{+3}$$

With X=C(read) / C@55%RH

MEASUREMENT FREQUENCY INFLUENCE

In this data sheet, all capacitance measurements are done @ 10 kHz / 1Volt. However, the sensor can operate without restriction from 5 kHz to 300 kHz.

POLARISATION

In order to get a better reproducibility during measurements, always connect the case of the header (pin 2) to the ground of the circuit. The case of the header is located on the opposite side of the tab.

SOLDERING INSTRUCTIONS

We recommend taking specific attention to soldering conditions to get the best performance of MEAS-France/Humirel sensors. See Application Note. To get it, please contact: humirel.application@meas-spec.com.

PROPORTIONAL VOLTAGE OUTPUT CIRCUIT

BLOCK DIAGRAM

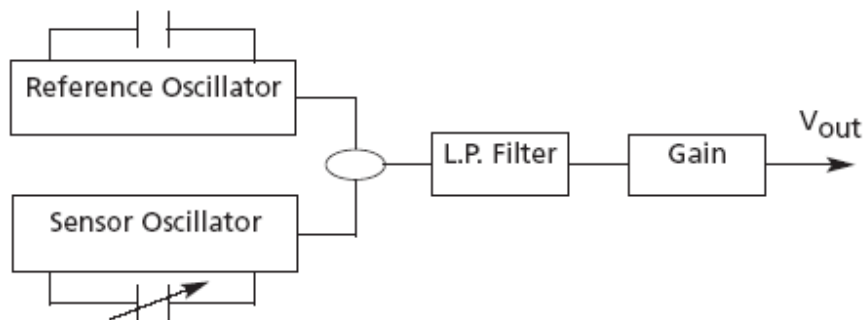

FREQUENCY OUTPUT CIRCUIT

CIRCUIT

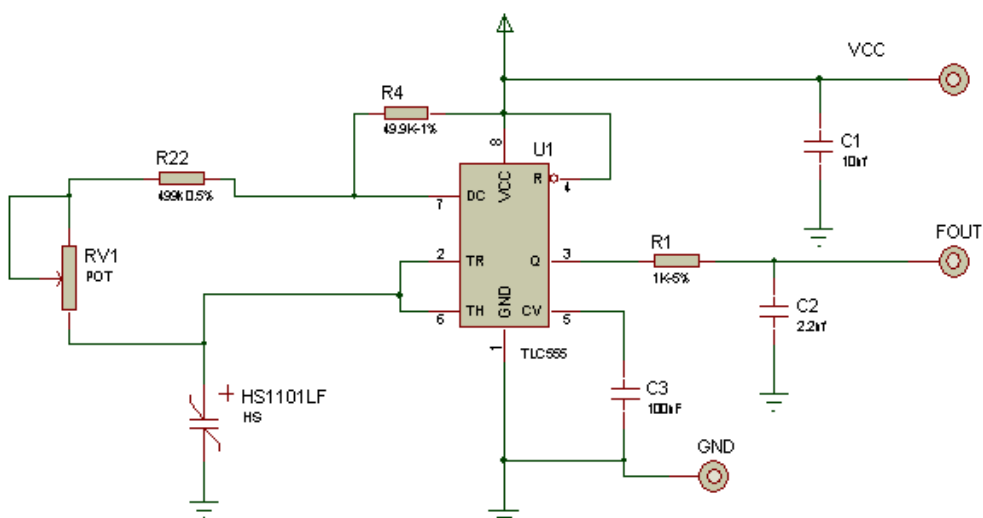

Note: R22=499kΩ / R4=49.9kΩ / R1=1 kΩ / RV1=50 kΩ potentiometer / C1=10nF / C2=2.2nF / C3=100nF

HS1101LF – Relative Humidity Sensor

This circuit is the typical astable design for 555. The HS1101LF, used as variable capacitor, is connected to the TRIG and THRES pin. Pin 7 is used as a short circuit pin for resistor R4.

The HS1101LF equivalent capacitor is charged through R22 and R4 to the threshold voltage (approximately 0.67Vcc) and discharged through R22 only to the trigger level (approximately 0.33Vcc) since R4 is shorted to ground by pin 7.

Since the charge and discharge of the sensor run through different resistors, R22 and R4, the duty cycle is determined by:

- $t_{high} = C @ \%RH * (R22 + R4) * \ln 2$
- $t_{low} = C @ \%RH * R22 * \ln 2$
- $F = 1 / (t_{high} + t_{low}) = 1 / (C @ \%RH * (R4 + 2 * R22) * \ln 2)$
- **Output duty cycle = $t_{high} * F = R22 / (R4 + 2 * R22)$**

To provide an output duty cycle close to 50%, R4 should be very low compared to R22 but never under a minimum value. Resistor R3 is a short circuit protection. 555 must be a CMOS version.

TYPICAL RESPONSE LOOK-UP TABLE

RH (%)	0	5	10	15	20	25	30	35	40	45	50
Fout (Hz)	-	-	7155	7080	7010	6945	6880	6820	6760	6705	6650
RH (%)	55	60	65	70	75	80	85	90	95	100	
Fout (Hz)	6600	6550	6500	6450	6400	6355	6305	6260	6210	-	

MEASUREMENT ERROR VS STRAY CAPACITANCE

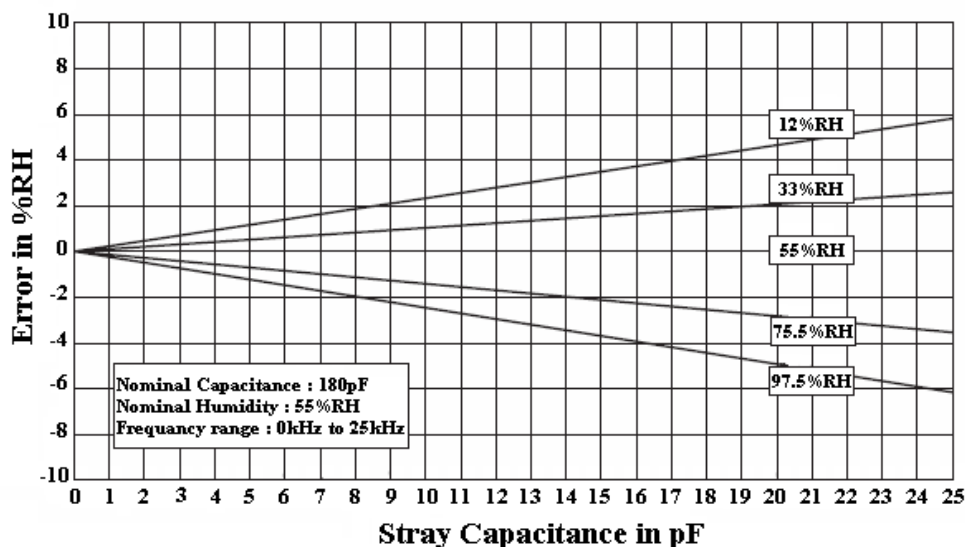

- Special attention is required in order to minimize stray capacitance in the layout. The added capacitance will act as a parallel capacitance with the sensor and create a measurement error.
- A careful coating of PCB and components must be implemented to prevent unexpected deviations of Fout in high humidity conditions.

QUALIFICATION PROCESS

HS1101LF sensors have been qualified through a complete qualification process taking in account many of the requirements of the JEDEC standard including:

- Solder heat and solderability including lead free process
- Pb free wave soldering and reflow soldering process(260°C) + DI water clean at 45°C
- Mechanical shock JESD-22-B104-A
- Vibration - Variable frequency(20 to 2000Hz) JESD-22-B103-A
- Marking permanency
- ESD - Electrostatic Discharge –Air Gun +-15kV(IEC 1000)
- Salt Atmosphere JESD22-A107-A
- Temperature Cycling - 40°C / +125°C
- High Temperature / Humidity Operating Life - 93%RH / 60°C for 1000 hours
- Low Humidity storage life - RH < 10%/23°C for 1000 hours
- Resistance to immersion in water at ambient temperature and 80°C
- High temperature storage 140°C for 168 hours
- Resistance to many chemicals linked to home appliances/automotive or consumer applications

PACKAGE OUTLINE

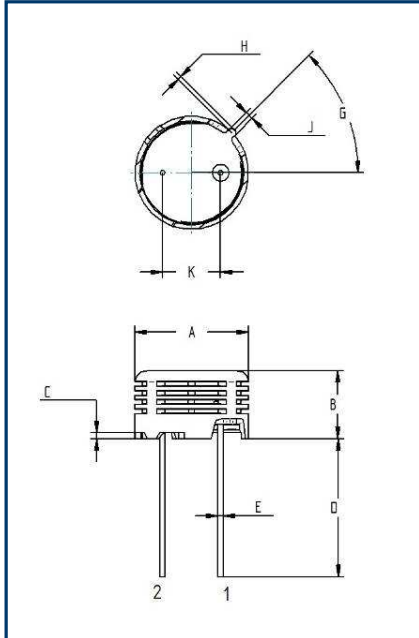

Dim	Min (mm)	Max (mm)
A	9.70	10.20
B	5.70	6.20
C	0.40	0.60
D	12.00	14.00
E	0.40	0.50
G	45°BCS	
H	0.70	1.10
J	0.70	0.90
K	4.83	5.33

HS1101LF – Relative Humidity Sensor



ORDERING INFORMATION

**HPP801A031 (MULTIPLE PACKAGE QUANTITY OF 48 PIECES)
HS1101LF - CAPACITIVE RELATIVE HUMIDITY SENSOR**

To distinguish HS1101 from HS1101LF, HS1101LF is designed with a black plastic cap

Sample kit of HS1101LF is available through MEASUREMENT SPECIALTIES web site:
<http://www.meas-spec.com/humidity-sensors.aspx>

Customer Service contact details



Measurement Specialties, Inc - MEAS France
Impasse Jeanne Benozzi
CS 83 163
31027 Toulouse Cedex 3
FRANCE
Tél: +33 (0)5 820 822 02
Fax: +33(0)5 820 821 51
Sales: humidity.sales@meas-spec.com

Revision	Comments	Who	Date
E	Deletion of "HS1100LF" reference into the document	D. LE GALL	April 07
F	Physical drawing change (before too fuzzy to read)	D. LE GALL	May 07
G	Standardized datasheet format	D. LE GALL	April 08
H	Temperature Coefficient adjustment	D. LE GALL	March 11
I	New MEAS template, MEAS-France contact details updated	D. LE GALL-ZIRILLI	October 12

The information in this sheet has been carefully reviewed and is believed to be accurate; however, no responsibility is assumed for inaccuracies. Furthermore, this information does not convey to the purchaser of such devices any license under the patent rights to the manufacturer. Measurement Specialties, Inc. reserves the right to make changes without further notice to any product herein. Measurement Specialties, Inc. makes no warranty, representation or guarantee regarding the suitability of its product for any particular purpose, nor does Measurement Specialties, Inc. assume any liability arising out of the application or use of any product or circuit and specifically disclaims any and all liability, including without limitation consequential or incidental damages. Typical parameters can and do vary in different applications. All operating parameters must be validated for each customer application by customer's technical experts. Measurement Specialties, Inc. does not convey any license under its patent rights nor the rights of others.

Looking for pricing, stock, or lifecycle information?

Click below to explore more details on WIN SOURCE:

-  [View HPP801A031 on WIN SOURCE](#)
-  [TE Connectivity Information](#)

Optimize Your Supply Chain with WIN SOURCE Solutions

-  Global Sourcing Solution
-  Obsolete Management
-  Cost Control Management
-  Shortage Management
-  Alternative Solution
-  Excess Inventory Management