



**THE DATASHEET OF
PLVA662A,215**



Important notice

Dear Customer,

On 7 February 2017 the former NXP Standard Product business became a new company with the tradename **Nexperia**. Nexperia is an industry leading supplier of Discrete, Logic and PowerMOS semiconductors with its focus on the automotive, industrial, computing, consumer and wearable application markets

In data sheets and application notes which still contain NXP or Philips Semiconductors references, use the references to Nexperia, as shown below.

Instead of <http://www.nxp.com>, <http://www.philips.com/> or <http://www.semiconductors.philips.com/>, use <http://www.nexperia.com>

Instead of sales.addresses@www.nxp.com or sales.addresses@www.semiconductors.philips.com, use salesaddresses@nexperia.com (email)

Replace the copyright notice at the bottom of each page or elsewhere in the document, depending on the version, as shown below:

- © NXP N.V. (year). All rights reserved or © Koninklijke Philips Electronics N.V. (year). All rights reserved

Should be replaced with:

- © **Nexperia B.V. (year). All rights reserved.**

If you have any questions related to the data sheet, please contact our nearest sales office via e-mail or telephone (details via salesaddresses@nexperia.com). Thank you for your cooperation and understanding,

Kind regards,

Team Nexperia

DATA SHEET

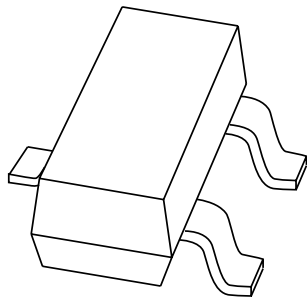

PLVA6xxA series Low-voltage avalanche regulator diodes

Product data sheet
Supersedes data of 1999 May 25

2004 Jan 14

Low-voltage avalanche regulator diodes

PLVA6xxA series

FEATURES

- Very low dynamic impedance at low currents: approximately $\frac{1}{20}$ of conventional series
- Hard breakdown knee
- Low noise: approximately $\frac{1}{10}$ of conventional series
- Total power dissipation: max. 250 mW
- Small tolerances of V_Z
- Working voltage range: nominal 5.00 to 6.80 V
- Non-repetitive peak reverse power dissipation: maximal 30 W.

APPLICATIONS

- Low current, low power, low noise applications
- CMOS RAM back-up circuits
- Voltage stabilizers
- Voltage limiters
- Smoke detector relays.

DESCRIPTION

High performance voltage regulator diodes in small SOT23 plastic SMD packages.

The series consists of PLVA650A to PLVA668A.

MARKING

TYPE NUMBER	MARKING CODE ⁽¹⁾
PLVA650A	*9A
PLVA653A	*9B
PLVA656A	*9C
PLVA659A	*9D
PLVA662A	*9E
PLVA665A	*9F
PLVA668A	*9G

Note

1. * = p: Made in Hong Kong.
 * = t: Made in Malaysia.
 * = W: Made in China.

PINNING

PIN	DESCRIPTION
1	anode
2	not connected
3	cathode

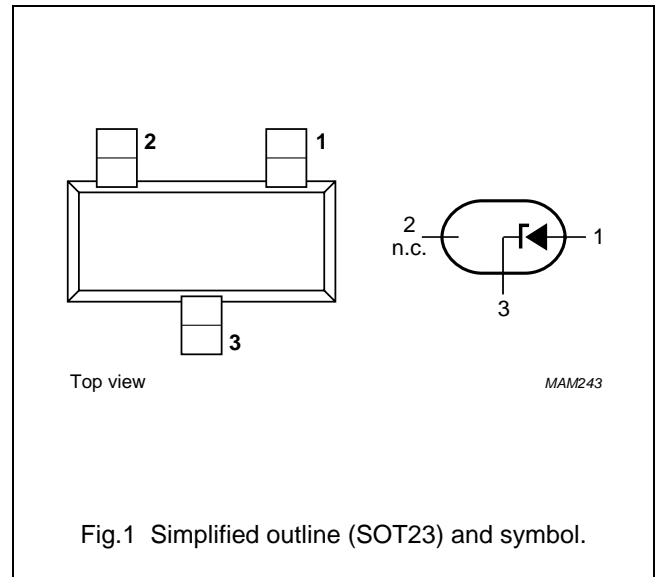

Low-voltage avalanche regulator diodes

PLVA6xxA series

ORDERING INFORMATION

TYPE NUMBER	PACKAGE		
	NAME	DESCRIPTION	VERSION
PLVA6xxA	–	plastic surface mounted package; 3 leads	SOT23

LIMITING VALUES

In accordance with the Absolute Maximum Rating System (IEC 60134).

SYMBOL	PARAMETER	CONDITIONS	MIN.	MAX.	UNIT
I_F	continuous forward current		–	250	mA
I_{ZRM}	repetitive peak working current	$t_p = 100 \mu\text{s}; \delta = 10\%$	–	250	mA
P_{ZSM}	non-repetitive peak reverse power dissipation	$t_p = 100 \mu\text{s}; T_j = 150 \text{ }^\circ\text{C}$	–	30	W
P_{tot}	total power dissipation	$T_{amb} = 25 \text{ }^\circ\text{C}; \text{note 1}$	–	250	mW
T_{stg}	storage temperature		–65	+150	$^\circ\text{C}$
T_j	junction temperature		–	150	$^\circ\text{C}$

Note

1. Device mounted on an FR4 printed circuit-board.

Low-voltage avalanche regulator diodes

PLVA6xxA series

ELECTRICAL CHARACTERISTICS $T_j = 25\text{ }^\circ\text{C}$; unless otherwise specified.

SYMBOL	PARAMETER	CONDITIONS	MIN.	TYP.	MAX.	UNIT
V_F	forward voltage	$I_F = 10\text{ mA}$	–	–	0.9	V
V_Z	working voltage	$I_Z = 250\text{ }\mu\text{A}$				
	PLVA650A		4.80	5.00	5.20	V
	PLVA653A		5.10	5.30	5.50	V
	PLVA656A		5.40	5.60	5.80	V
	PLVA659A		5.70	5.90	6.10	V
	PLVA662A		6.00	6.20	6.40	V
	PLVA665A		6.30	6.50	6.70	V
	PLVA668A		6.60	6.80	7.00	V
V_Z	working voltage	$I_Z = 10\text{ }\mu\text{A}$				
	PLVA650A		–	4.30	–	V
	PLVA653A		–	5.20	–	V
	PLVA656A		–	5.51	–	V
	PLVA659A		–	5.85	–	V
	PLVA662A		–	6.19	–	V
	PLVA665A		–	6.49	–	V
	PLVA668A		–	6.80	–	V
R_Z	dynamic resistance	1 kHz superimposed; I_{ZAC} is 10% of I_{ZDC} ; $I_Z = 250\text{ }\mu\text{A}$				
	PLVA650A		–	–	700	Ω
	PLVA653A		–	–	250	Ω
	PLVA656A to PLVA668A		–	–	100	Ω
S_Z	temperature coefficient	$I_Z = 250\text{ }\mu\text{A}$				
	PLVA650A		–	0.20	–	mV/K
	PLVA653A		–	1.60	–	mV/K
	PLVA656A		–	1.90	–	mV/K
	PLVA659A		–	2.40	–	mV/K
	PLVA662A		–	2.65	–	mV/K
	PLVA665A		–	2.90	–	mV/K
	PLVA668A		–	3.40	–	mV/K
I_R	reverse current	$V_R = 80\% V_Z$ nominal				
	PLVA650A		–	–	20000	nA
	PLVA653A		–	–	5000	nA
	PLVA656A		–	–	1000	nA
	PLVA659A		–	–	500	nA
	PLVA662A		–	–	100	nA
	PLVA665A		–	–	50	nA
	PLVA668A		–	–	10	nA

Low-voltage avalanche regulator diodes

PLVA6xxA series

SYMBOL	PARAMETER	CONDITIONS	MIN.	TYP.	MAX.	UNIT
I_R	reverse current	$V_R = 50\% V_Z$ nominal				
	PLVA650A		–	34	–	nA
	PLVA653A		–	22	–	nA
	PLVA656A		–	1.1	–	nA
	PLVA659A		–	0.9	–	nA
	PLVA662A		–	0.9	–	nA
	PLVA665A		–	0.9	–	nA
I_R	reverse current	$V_R = 90\% V_Z$ nominal				
	PLVA650A		–	21	–	μ A
	PLVA653A		–	3.5	–	μ A
	PLVA656A		–	1.3	–	μ A
	PLVA659A		–	1.0	–	μ A
	PLVA662A		–	0.05	–	μ A
	PLVA665A		–	0.04	–	μ A
	PLVA668A		–	0.006	–	μ A
ΔV_Z	line regulation					
	PLVA659A to PLVA668A	$I_{LO} = 10 \mu\text{A}; I_{HI} = 1 \text{ mA}$	–	–	0.1	V
	PLVA656A	$I_{LO} = 50 \mu\text{A}; I_{HI} = 1 \text{ mA}$	–	–	0.1	V
	PLVA650A	$I_{LO} = 100 \mu\text{A}; I_{HI} = 1 \text{ mA}$	–	–	0.4	V
	PLVA653A	$I_{LO} = 100 \mu\text{A}; I_{HI} = 1 \text{ mA}$	–	–	0.2	V
V_n	noise voltage density	$f = 1 \text{ kHz}; B = 1 \text{ kHz}; I_Z = 250 \mu\text{A}$	–	–	1.0	$\frac{\mu\text{V}}{\sqrt{\text{Hz}}}$

THERMAL CHARACTERISTICS

SYMBOL	PARAMETER	CONDITIONS	VALUE	UNIT
$R_{th(j-tp)}$	thermal resistance from junction to tie-point		330	K/W
$R_{th(j-a)}$	thermal resistance from junction to ambient	note 1	500	K/W

Note

1. Device mounted on an FR4 printed circuit-board.

Low-voltage avalanche regulator diodes

PLVA6xxA series

PACKAGE OUTLINE

Plastic surface-mounted package; 3 leads

SOT23

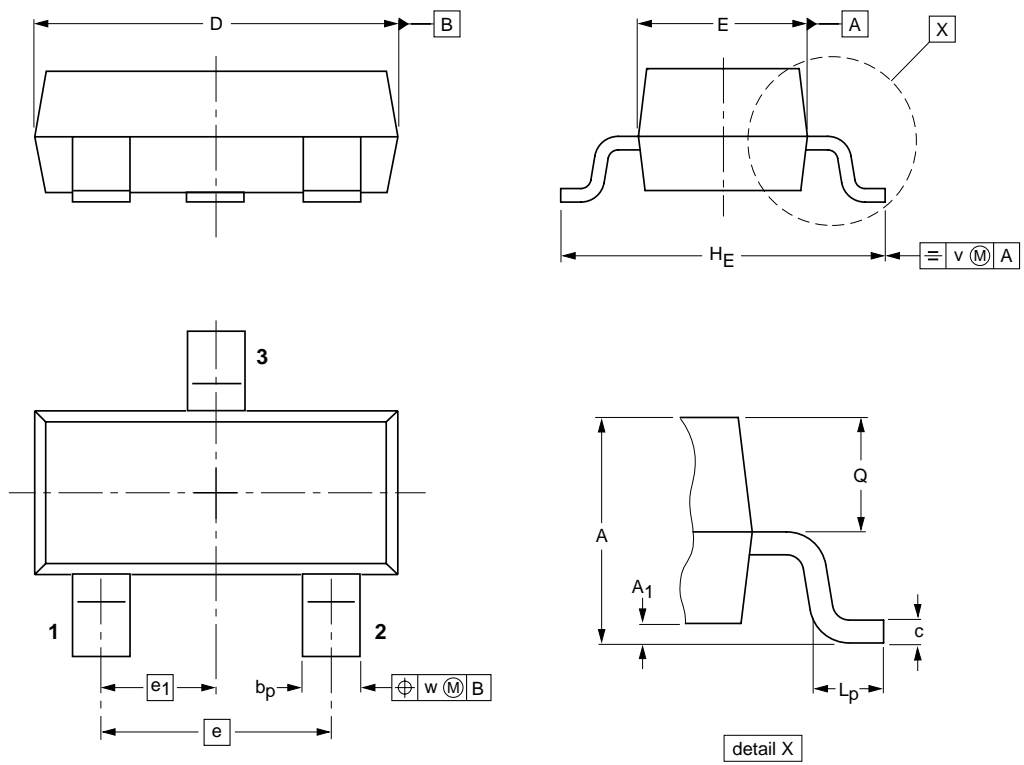

DIMENSIONS (mm are the original dimensions)

UNIT	A	A ₁ max.	b _p	c	D	E	e	e ₁	H _E	L _p	Q	v	w
mm	1.1 0.9	0.1	0.48 0.38	0.15 0.09	3.0 2.8	1.4 1.2	1.9	0.95	2.5 2.1	0.45 0.15	0.55 0.45	0.2	0.1

OUTLINE VERSION	REFERENCES				EUROPEAN PROJECTION	ISSUE DATE
	IEC	JEDEC	JEITA			
SOT23		TO-236AB				04-11-04 06-03-16

Low-voltage avalanche regulator diodes

PLVA6xxA series

DATA SHEET STATUS

DOCUMENT STATUS ⁽¹⁾	PRODUCT STATUS ⁽²⁾	DEFINITION
Objective data sheet	Development	This document contains data from the objective specification for product development.
Preliminary data sheet	Qualification	This document contains data from the preliminary specification.
Product data sheet	Production	This document contains the product specification.

Notes

1. Please consult the most recently issued document before initiating or completing a design.
2. The product status of device(s) described in this document may have changed since this document was published and may differ in case of multiple devices. The latest product status information is available on the Internet at URL <http://www.nxp.com>.

DISCLAIMERS

General — Information in this document is believed to be accurate and reliable. However, NXP Semiconductors does not give any representations or warranties, expressed or implied, as to the accuracy or completeness of such information and shall have no liability for the consequences of use of such information.

Right to make changes — NXP Semiconductors reserves the right to make changes to information published in this document, including without limitation specifications and product descriptions, at any time and without notice. This document supersedes and replaces all information supplied prior to the publication hereof.

Suitability for use — NXP Semiconductors products are not designed, authorized or warranted to be suitable for use in medical, military, aircraft, space or life support equipment, nor in applications where failure or malfunction of an NXP Semiconductors product can reasonably be expected to result in personal injury, death or severe property or environmental damage. NXP Semiconductors accepts no liability for inclusion and/or use of NXP Semiconductors products in such equipment or applications and therefore such inclusion and/or use is at the customer's own risk.

Applications — Applications that are described herein for any of these products are for illustrative purposes only. NXP Semiconductors makes no representation or warranty that such applications will be suitable for the specified use without further testing or modification.

Limiting values — Stress above one or more limiting values (as defined in the Absolute Maximum Ratings System of IEC 60134) may cause permanent damage to the device. Limiting values are stress ratings only and operation of the device at these or any other conditions

above those given in the Characteristics sections of this document is not implied. Exposure to limiting values for extended periods may affect device reliability.

Terms and conditions of sale — NXP Semiconductors products are sold subject to the general terms and conditions of commercial sale, as published at <http://www.nxp.com/profile/terms>, including those pertaining to warranty, intellectual property rights infringement and limitation of liability, unless explicitly otherwise agreed to in writing by NXP Semiconductors. In case of any inconsistency or conflict between information in this document and such terms and conditions, the latter will prevail.

No offer to sell or license — Nothing in this document may be interpreted or construed as an offer to sell products that is open for acceptance or the grant, conveyance or implication of any license under any copyrights, patents or other industrial or intellectual property rights.

Export control — This document as well as the item(s) described herein may be subject to export control regulations. Export might require a prior authorization from national authorities.

Quick reference data — The Quick reference data is an extract of the product data given in the Limiting values and Characteristics sections of this document, and as such is not complete, exhaustive or legally binding.

NXP Semiconductors

Customer notification

This data sheet was changed to reflect the new company name NXP Semiconductors, including new legal definitions and disclaimers. No changes were made to the technical content, except for package outline drawings which were updated to the latest version.

Contact information

For additional information please visit: <http://www.nxp.com>

For sales offices addresses send e-mail to: salesaddresses@nxp.com

© NXP B.V. 2009

All rights are reserved. Reproduction in whole or in part is prohibited without the prior written consent of the copyright owner.

The information presented in this document does not form part of any quotation or contract, is believed to be accurate and reliable and may be changed without notice. No liability will be accepted by the publisher for any consequence of its use. Publication thereof does not convey nor imply any license under patent- or other industrial or intellectual property rights.

Printed in The Netherlands

R76/03/pp8

Date of release: 2004 Jan 14



Document order number: 9397 750 12445

founded by

PHILIPS

Looking for pricing, stock, or lifecycle information?

Click below to explore more details on WIN SOURCE:

-  [View PLVA662A,215 on WIN SOURCE](#)
-  [Nexperia USA Inc. Information](#)

Optimize Your Supply Chain with WIN SOURCE Solutions

-  Global Sourcing Solution
-  Obsolete Management
-  Cost Control Management
-  Shortage Management
-  Alternative Solution
-  Excess Inventory Management