







**THE DATASHEET OF
SD24C-01FTG**



SD-C Series 450W Discrete Bidirectional TVS Diode    



Pinout and Functional Block Diagram

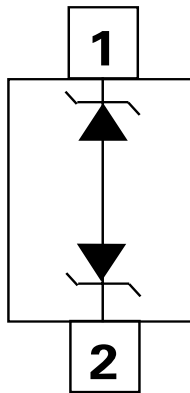

Description

The SD-C series can safely absorb repetitive ESD strikes at $\pm 30\text{kV}$ (contact discharge, IEC 61000-4-2) without performance degradation and safely dissipate 30A (SD05C) of 8/20 μs induced surge current (IEC 61000-4-5 2ND Edition) with very low clamping voltages.

Features

- ESD, IEC 61000-4-2, $\pm 30\text{kV}$ contact, $\pm 30\text{kV}$ air
- EFT, IEC 61000-4-4, 40A (5/50ns)
- Lightning, 30A (8/20 as defined in IEC 61000-4-5 2nd edition) SD05C
- Low clamping voltage
- Low leakage current
- Small SOD323 package fits 0805 footprints
- AEC-Q101 qualified
- RoHS Compliant and Lead Free
- Moisture Sensitivity Level (MSL-1)

Applications

- Switches / Buttons
- Test Equipment / Instrumentation
- Point-of-Sale Terminals
- Medical Equipment
- Notebooks / Desktops / Servers
- Computer Peripherals
- Automotive Electronics

Additional Information



Datasheet



Resources



Samples

Life Support Note:

Not Intended for Use in Life Support or Life Saving Applications

The products shown herein are not designed for use in life sustaining or life saving applications unless otherwise expressly indicated.

Absolute Maximum Ratings

Symbol	Parameter	Value	Units
P_{pk}	Peak Pulse Power ($t_p=8/20\mu s$)	450	W
T_{OP}	Operating Temperature	-40 to 125	°C
T_{STOR}	Storage Temperature	-55 to 150	°C

Note:

CAUTION: Stresses above those listed in "Absolute Maximum Ratings" may cause permanent damage to the device. This is a stress only rating and operation of the component at these or any other conditions above those indicated in the operational sections of this specification is not implied.

SD05C Electrical Characteristics ($T_{OP}=25^\circ C$)

Parameter	Symbol	Test Conditions	Min	Typ	Max	Units
Reverse Standoff Voltage	V_{RWM}	$I_R=1\mu A$	-	-	5.0	V
Breakdown Voltage	V_R	$I_R=1mA$	6.0	-	-	V
Reverse Leakage Current	I_{LEAK}	$V_R=5V$	-	-	1.0	μA
Clamp Voltage ¹	V_C	$I_{pp}=1A, t_p=8/20\mu s, Fwd$	-	-	10.0	V
		$I_{pp}=10A, t_p=8/20\mu s, Fwd$	-	-	14.5	V
Dynamic Resistance ²	R_{DYN}	TLP, $t_p=100ns$, I/O to Ground	-	0.31	-	Ω
Peak Pulse Current	I_{pp}	$t_p=8/20\mu s$	-	-	30.0	A
ESD Withstand Voltage ¹	V_{ESD}	IEC 61000-4-2 (Contact Discharge)	± 30	-	-	kV
		IEC 61000-4-2 (Air Discharge)	± 30	-	-	kV
Diode Capacitance ¹	$C_{I/O-I/O}$	Reverse Bias=0V, f=1MHz	-	-	200	pF

SD12C Electrical Characteristics ($T_{OP}=25^\circ C$)

Parameter	Symbol	Test Conditions	Min	Typ	Max	Units
Reverse Standoff Voltage	V_{RWM}	$I_R=1\mu A$	-	-	12.0	V
Breakdown Voltage	V_R	$I_R=1mA$	13.3	-	-	V
Reverse Leakage Current	I_{LEAK}	$V_R=12V$	-	-	1.0	μA
Clamp Voltage ¹	V_C	$I_{pp}=1A, t_p=8/20\mu s, Fwd$	-	-	18.5	V
		$I_{pp}=10A, t_p=8/20\mu s, Fwd$	-	-	23.0	V
Dynamic Resistance ²	R_{DYN}	TLP, $t_p=100ns$, I/O to Ground	-	0.41	-	Ω
Peak Pulse Current	I_{pp}	$t_p=8/20\mu s$	-	-	17.0	A
ESD Withstand Voltage ¹	V_{ESD}	IEC 61000-4-2 (Contact Discharge)	± 30	-	-	kV
		IEC 61000-4-2 (Air Discharge)	± 30	-	-	kV
Diode Capacitance ¹	$C_{I/O-I/O}$	Reverse Bias=0V, f=1MHz	-	-	100	pF

SD15C Electrical Characteristics (T_{OP}=25°C)

Parameter	Symbol	Test Conditions	Min	Typ	Max	Units
Reverse Standoff Voltage	V _{RWM}	I _R =1μA	-	-	15.0	V
Breakdown Voltage	V _R	I _R =1mA	16.7	-	-	V
Reverse Leakage Current	I _{LEAK}	V _R =15V	-	-	1.0	μA
Clamp Voltage ¹	V _C	I _{PP} =1A, t _p =8/20μs, Fwd	-	-	24.0	V
		I _{PP} =10A, t _p =8/20μs, Fwd	-	-	31.0	V
Dynamic Resistance ²	R _{DYN}	TLP, tp=100ns, I/O to Ground	-	0.46	-	Ω
Peak Pulse Current	I _{PP}	t _p =8/20μs	-	-	12.0	A
ESD Withstand Voltage ¹	V _{ESD}	IEC 61000-4-2 (Contact Discharge)	±30	-	-	kV
		IEC 61000-4-2 (Air Discharge)	±30	-	-	kV
Diode Capacitance ¹	C _{I/O-I/O}	Reverse Bias=0V, f=1MHz	-	-	75	pF

SD24C Electrical Characteristics (T_{OP}=25°C)

Parameter	Symbol	Test Conditions	Min	Typ	Max	Units
Reverse Standoff Voltage	V _{RWM}	I _R =1μA	-	-	24.0	V
Breakdown Voltage	V _R	I _R =1mA	26.7	-	-	V
Reverse Leakage Current	I _{LEAK}	V _R =24V	-	-	1.0	μA
Clamp Voltage ¹	V _C	I _{PP} =1A, t _p =8/20μs, Fwd	-	-	34.0	V
		I _{PP} =5A, t _p =8/20μs, Fwd	-	-	42.0	V
Dynamic Resistance ²	R _{DYN}	TLP, tp=100ns, I/O to Ground	-	0.62	-	Ω
Peak Pulse Current	I _{PP}	t _p =8/20μs	-	-	7.0	A
ESD Withstand Voltage ¹	V _{ESD}	IEC 61000-4-2 (Contact Discharge)	±30	-	-	kV
		IEC 61000-4-2 (Air Discharge)	±30	-	-	kV
Diode Capacitance ¹	C _{I/O-I/O}	Reverse Bias=0V, f=1MHz	-	-	50	pF

SD36C Electrical Characteristics (T_{OP}=25°C)

Parameter	Symbol	Test Conditions	Min	Typ	Max	Units
Reverse Standoff Voltage	V _{RWM}	I _R =1μA	-	-	36.0	V
Breakdown Voltage	V _R	I _R =1mA	40.0	-	-	V
Reverse Leakage Current	I _{LEAK}	V _R =36V	-	-	1.0	μA
Clamp Voltage ¹	V _C	I _{PP} =1A, t _p =8/20μs, Fwd	-	-	50.0	V
		I _{PP} =4A, t _p =8/20μs, Fwd	-	-	60.0	V
Dynamic Resistance ²	R _{DYN}	TLP, tp=100ns, I/O to Ground	-	0.68	-	Ω
Peak Pulse Current	I _{PP}	t _p =8/20μs	-	-	5.0	A
ESD Withstand Voltage ¹	V _{ESD}	IEC 61000-4-2 (Contact Discharge)	±30	-	-	kV
		IEC 61000-4-2 (Air Discharge)	±30	-	-	kV
Diode Capacitance ¹	C _{I/O-I/O}	Reverse Bias=0V, f=1MHz	-	-	30	pF

Note:

- Parameter is guaranteed by design and/or component characterization.
- Transmission Line Pulse (TLP) with 100ns width and 200ps rise time.

Capacitance vs. Bias

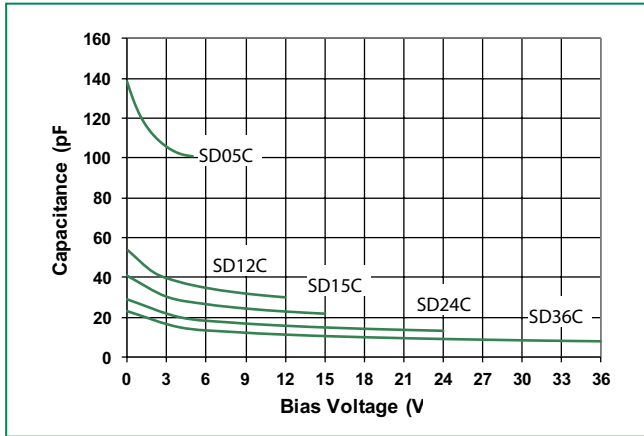

Power Derating Curve

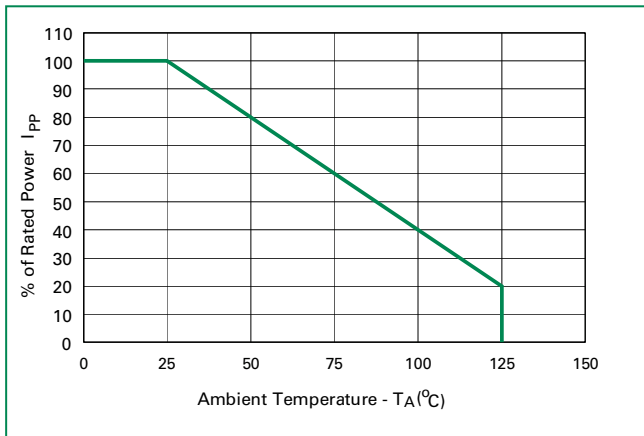

8/20 μ s Pulse Waveform

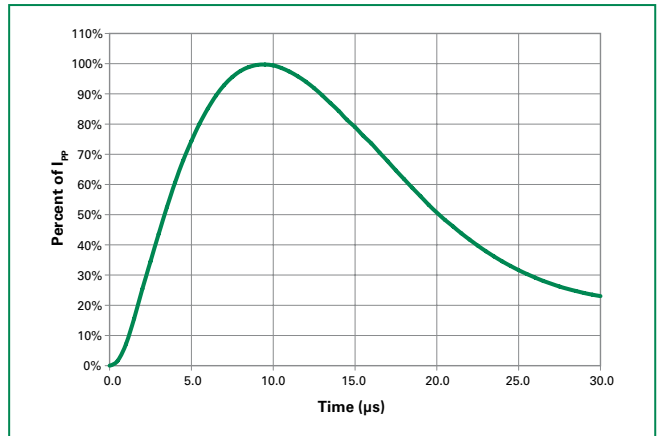

SD05C Transmission Line Pulsing (TLP) Plot

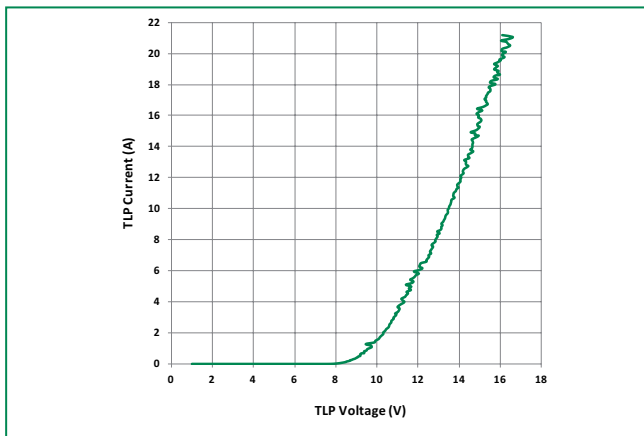

SD12C Transmission Line Pulsing (TLP) Plot

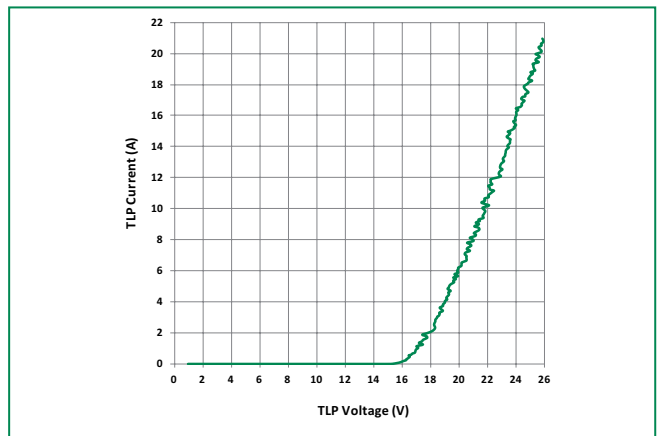

SD15C Transmission Line Pulsing(TLP) Plot

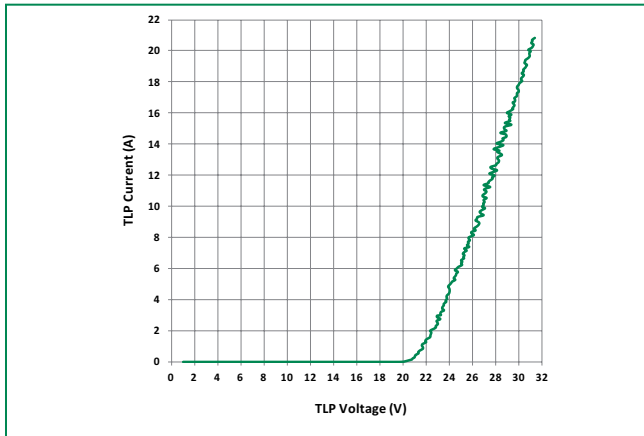

SD24C Transmission Line Pulsing(TLP) Plot

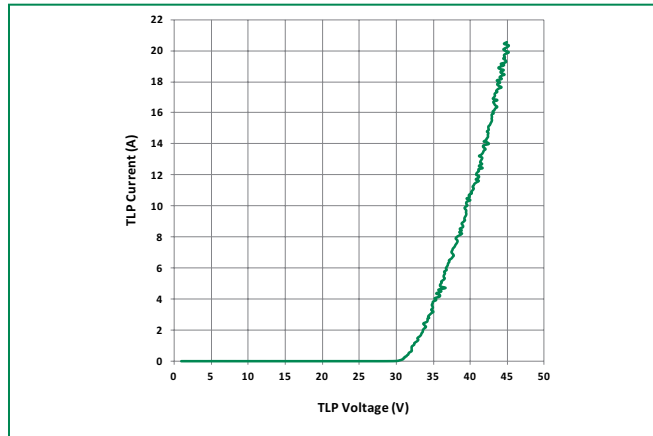

SD36C Transmission Line Pulsing(TLP) Plot

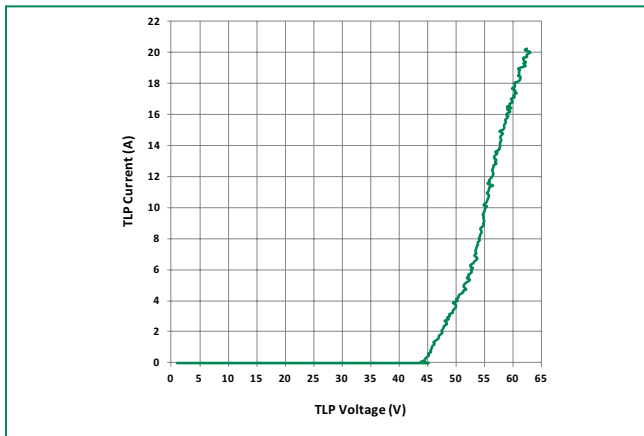

Soldering Parameters

Reflow Condition		Pb – Free assembly
Pre Heat	- Temperature Min ($T_{s(min)}$)	150°C
	- Temperature Max ($T_{s(max)}$)	200°C
	- Time (min to max) (t_s)	60 – 180 secs
Average ramp up rate (Liquidus) Temp (T_L) to peak		3°C/second max
$T_{s(max)}$ to T_L - Ramp-up Rate		3°C/second max
Reflow	- Temperature (T_L) (Liquidus)	217°C
	- Temperature (t_L)	60 – 150 seconds
Peak Temperature (T_p)		260 ^{+0/-5} °C
Time within 5°C of actual peak Temperature (t_p)		20 – 40 seconds
Ramp-down Rate		6°C/second max
Time 25°C to peak Temperature (T_p)		8 minutes Max.
Do not exceed		260°C

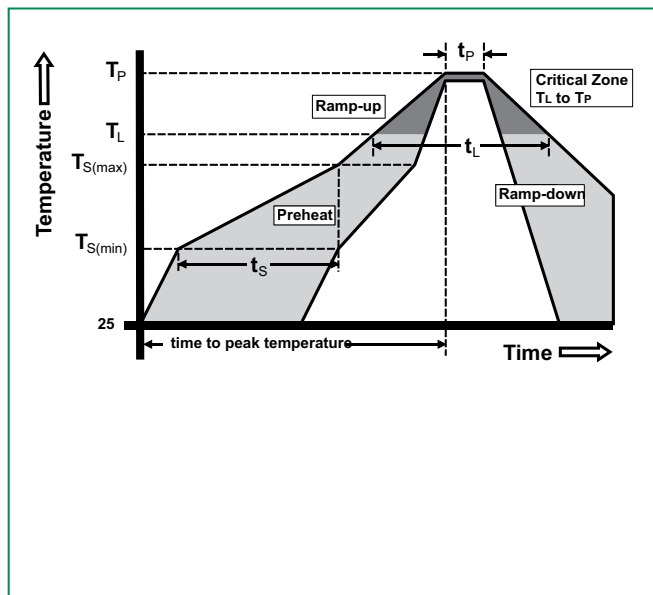

Product Characteristics

Lead Plating	Matte Tin
Lead Material	Copper Alloy
Lead Coplanarity	0.0004 inches (0.102mm)
Substrate material	Silicon
Body Material	Molded Compound
Flammability	UL Recognized compound meeting flammability rating V-0

Ordering Information

Part Number	Package	Min. Order Qty.
SD05C-01FTG	SOD323	3000
SD12C-01FTG	SOD323	3000
SD15C-01FTG	SOD323	3000
SD24C-01FTG	SOD323	3000
SD36C-01FTG	SOD323	3000

Part Marking System

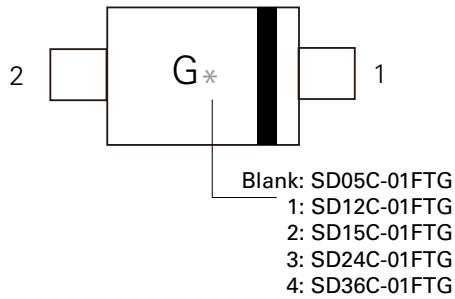

Part Numbering System

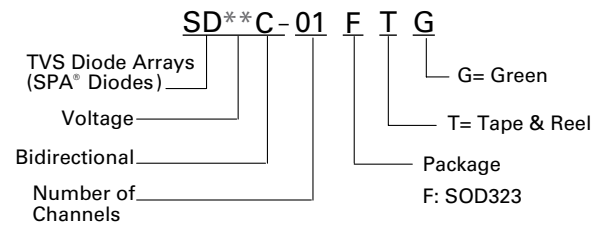

Package Dimensions -SOD323

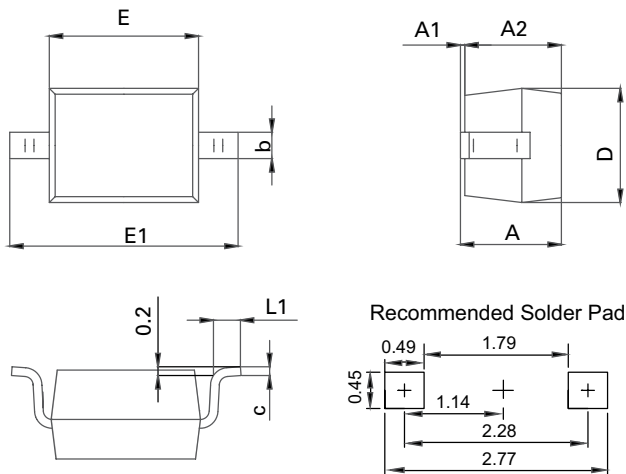

Unit: mm

Symbol	SOD323			
	Millimeters		Inches	
	Min	Max	Min	Max
A	0.8	1.14	0.031	0.045
A1	0.00	0.10	0.000	0.004
A2	0.80	1.04	0.031	0.014
b	0.25	0.35	0.010	0.014
c	0.08	0.15	0.003	0.006
D	1.15	1.45	0.045	0.057
E	1.60	1.90	0.063	0.075
E1	2.44	2.70	0.096	0.106
L1	0.25	0.45	0.010	0.018

Embossed Carrier Tape & Reel Specification – SOD323

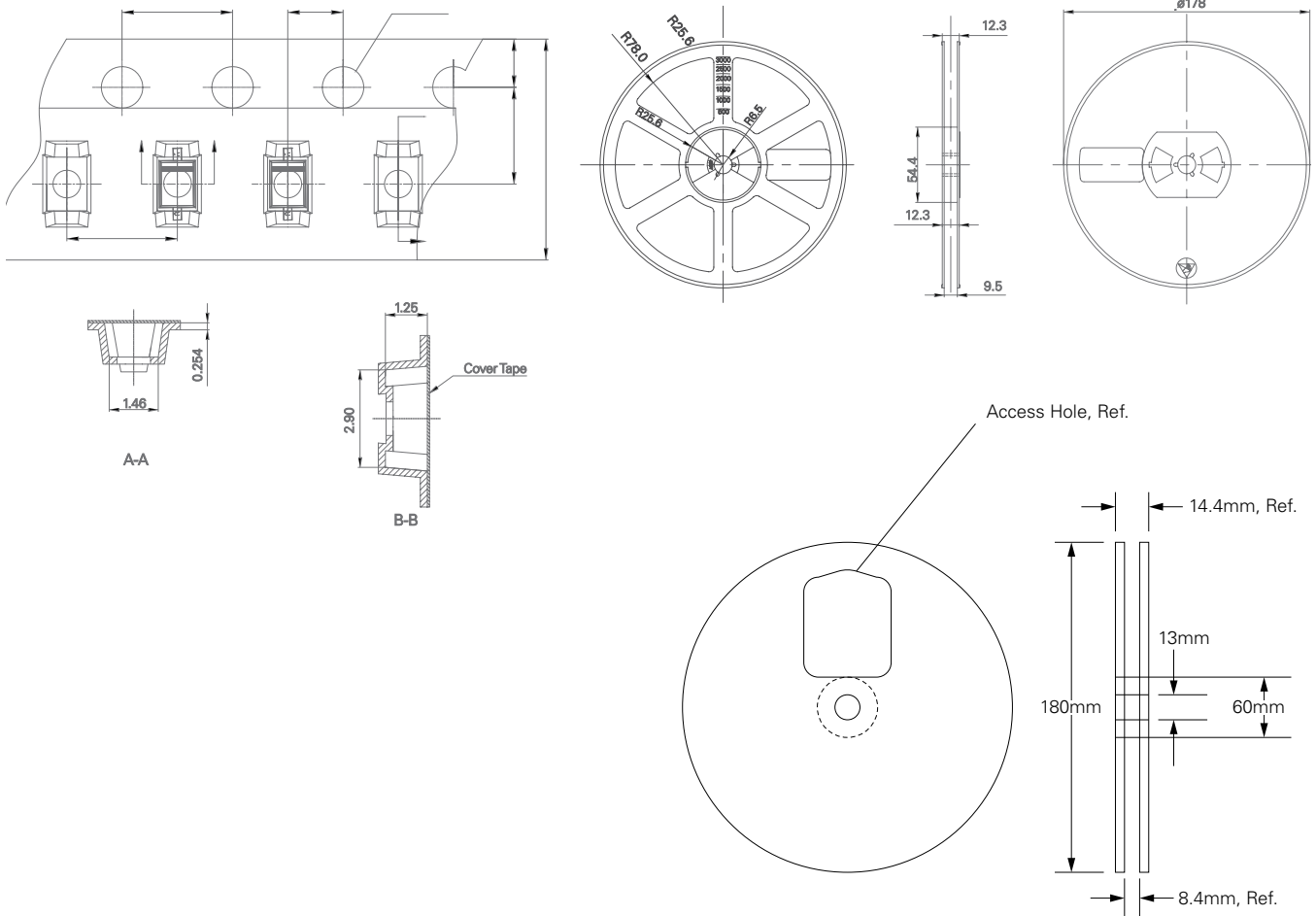

Looking for pricing, stock, or lifecycle information?

Click below to explore more details on WIN SOURCE:

 [View SD24C-01FTG on WIN SOURCE](#)

 [Littelfuse Inc. Information](#)

Optimize Your Supply Chain with WIN SOURCE Solutions

-  Global Sourcing Solution
-  Obsolete Management
-  Cost Control Management
-  Shortage Management
-  Alternative Solution
-  Excess Inventory Management