



**THE DATASHEET OF
PESD3V3L2UM,315**



Important notice

Dear Customer,

On 7 February 2017 the former NXP Standard Product business became a new company with the tradename **Nexperia**. Nexperia is an industry leading supplier of Discrete, Logic and PowerMOS semiconductors with its focus on the automotive, industrial, computing, consumer and wearable application markets

In data sheets and application notes which still contain NXP or Philips Semiconductors references, use the references to Nexperia, as shown below.

Instead of <http://www.nxp.com>, <http://www.philips.com/> or <http://www.semiconductors.philips.com/>, use <http://www.nexperia.com>

Instead of sales.addresses@www.nxp.com or sales.addresses@www.semiconductors.philips.com, use salesaddresses@nexperia.com (email)

Replace the copyright notice at the bottom of each page or elsewhere in the document, depending on the version, as shown below:

- © NXP N.V. (year). All rights reserved or © Koninklijke Philips Electronics N.V. (year). All rights reserved

Should be replaced with:

- © **Nexperia B.V. (year). All rights reserved.**

If you have any questions related to the data sheet, please contact our nearest sales office via e-mail or telephone (details via salesaddresses@nexperia.com). Thank you for your cooperation and understanding,

Kind regards,

Team Nexperia

DATA SHEET

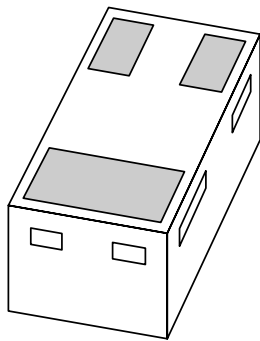

PESDxL2UM series Low capacitance double ESD protection diode

Product data sheet
Supersedes data of 2003 Aug 05

2005 May 23

Low capacitance double ESD protection diode

PESDxL2UM series

FEATURES

- Uni-directional ESD protection of two lines or bi-directional ESD protection of one line
- Reverse standoff voltage 3.3 and 5 V
- Low diode capacitance
- Ultra low leakage current
- Leadless ultra small SOT883 surface mount package (1 × 0.6 × 0.5 mm)
- Board space 1.17 mm² (approx. 10% of SOT23)
- ESD protection >15 kV
- IEC 61000-4-2; level 4 (ESD); 15 kV (air) or 8 kV (contact).

APPLICATIONS

- Cellular handsets and accessories
- Portable electronics
- Computers and peripherals
- Communication systems
- Audio and video equipment.

MARKING

TYPE NUMBER	MARKING CODE
PESD3V3L2UM	F2
PESD5V0L2UM	F1

DESCRIPTION

Low capacitance ESD protection diode in a three pad SOT883 leadless ultra small plastic package designed to protect up to two transmission or data lines from ElectroStatic Discharge (ESD) damage.

PINNING

PIN	DESCRIPTION
1	cathode 1
2	cathode 2
3	common anode

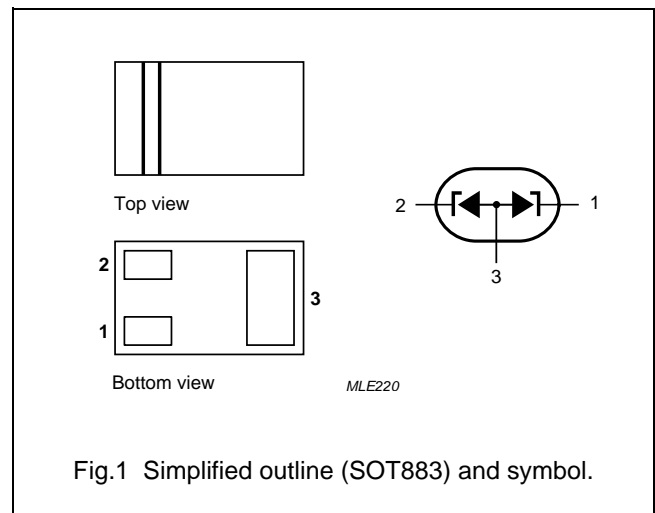

Low capacitance double ESD protection diode

PESDxL2UM series

LIMITING VALUES

In accordance with the Absolute Maximum Rating System (IEC 60134).

SYMBOL	PARAMETER	CONDITIONS	MIN.	MAX.	UNIT
Per diode					
I _{pp}	peak pulse current	8/20 μs pulse; notes 1, 2 and 3	–	3	A
	PESD3V3L2UM PESD5V0L2UM			2.5	A
P _{pp}	peak pulse power	8/20 μs pulse; notes 1, 2 and 3	–	30	W
I _{FSM}	non-repetitive peak forward current	t _p = 1 ms; square pulse	–	3.5	A
I _{ZSM}	non-repetitive peak reverse current	t _p = 1 ms; square pulse	–	0.9	A
	PESD3V3L2UM PESD5V0L2UM			0.8	A
P _{tot}	total power dissipation	T _{amb} = 25 °C; note 4	–	250	mW
P _{ZSM}	non-repetitive peak reverse power dissipation	t _p = 1 ms; square pulse; see Fig.4	–	6	W
T _{stg}	storage temperature		–65	+150	°C
T _j	junction temperature		–	150	°C
ESD	electrostatic discharge	IEC 61000-4-2 (contact discharge)	15	–	kV
		HBM MIL-Std 883	10	–	kV

Notes

1. Non-repetitive current pulse 8/20 μs exponential decay waveform; see Fig.5.
2. Pins 1 and 3 or 2 and 3.
3. Pins 1 and 2.
4. Device mounted on standard printed-circuit board.

ESD standards compliance

IEC 61000-4-2, level 4 (ESD)	>15 kV (air); >8 kV (contact)
HBM MIL-Std 883, class 3	>4 kV

THERMAL CHARACTERISTICS

SYMBOL	PARAMETER	CONDITIONS	VALUE	UNIT
R _{th j-a}	thermal resistance from junction to ambient	all diodes loaded; note 1	500	K/W
		one diode loaded; note 2	290	K/W

Notes

1. Refer to SOT883 standard mounting conditions (footprint), FR4 with 60 μm copper strip line.
2. FR4 single-sided copper 1 cm².

Low capacitance double ESD protection diode

PESDxL2UM series

ELECTRICAL CHARACTERISTICS

$T_j = 25\text{ }^\circ\text{C}$ unless otherwise specified.

SYMBOL	PARAMETER	CONDITIONS	MIN.	TYP.	MAX.	UNIT
Per diode						
V_F	forward voltage	$I_F = 200\text{ mA}$	–	1	1.2	V
V_{RWM}	reverse stand-off voltage					
	PESD3V3L2UM		–	–	3.3	V
	PESD5V0L2UM		–	–	5	V
I_{RM}	reverse leakage current					
	PESD3V3L2UM	$V_R = 3.3\text{ V}$	–	75	300	nA
	PESD5V0L2UM	$V_R = 5\text{ V}$	–	5	25	nA
$V_{(CL)R}$	clamping voltage	8/20 μs pulse				
	PESD3V3L2UM	$I_{pp} = 1\text{ A}$; notes 1 and 2	–	–	8	V
		$I_{pp} = 3\text{ A}$; notes 1 and 2	–	–	12	V
		$I_{pp} = 1\text{ A}$; notes 1 and 3	–	–	9	V
		$I_{pp} = 3\text{ A}$; notes 1 and 3	–	–	13	V
	PESD5V0L2UM	$I_{pp} = 1\text{ A}$; notes 1 and 2	–	–	10	V
		$I_{pp} = 2.5\text{ A}$; notes 1 and 2	–	–	13	V
		$I_{pp} = 1\text{ A}$; notes 1 and 3	–	–	11	V
		$I_{pp} = 2.5\text{ A}$; notes 1 and 3	–	–	15	V
V_{BR}	breakdown voltage	$I_Z = 1\text{ mA}$				
	PESD3V3L2UM		5.32	5.6	5.88	V
	PESD5V0L2UM		6.46	6.8	7.14	V
S_Z	temperature coefficient	$I_Z = 1\text{ mA}$				
	PESD3V3L2UM		–	1.3	–	mV/K
	PESD5V0L2UM		–	2.9	–	mV/K
r_{diff}	differential resistance	$I_R = 1\text{ mA}$				
	PESD3V3L2UM		–	–	200	Ω
	PESD5V0L2UM		–	–	100	Ω
C_d	diode capacitance					
	PESD3V3L2UM	$f = 1\text{ MHz}$; $V_R = 0$	–	22	28	pF
		$f = 1\text{ MHz}$; $V_R = 5$	–	12	17	pF
	PESD5V0L2UM	$f = 1\text{ MHz}$; $V_R = 0$	–	16	19	pF
		$f = 1\text{ MHz}$; $V_R = 5$	–	8	11	pF

Notes

1. Non-repetitive current pulse 8/20 μs exponential decay waveform; see Fig.5.
2. Pins 1 and 3 or 2 and 3.
3. Pins 1 and 2.

Low capacitance double ESD protection diode

PESDxL2UM series

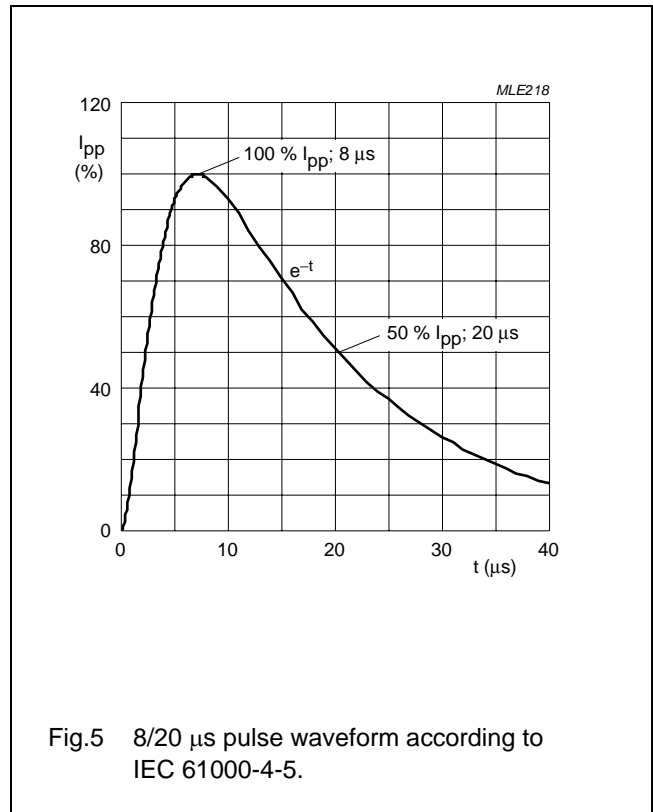
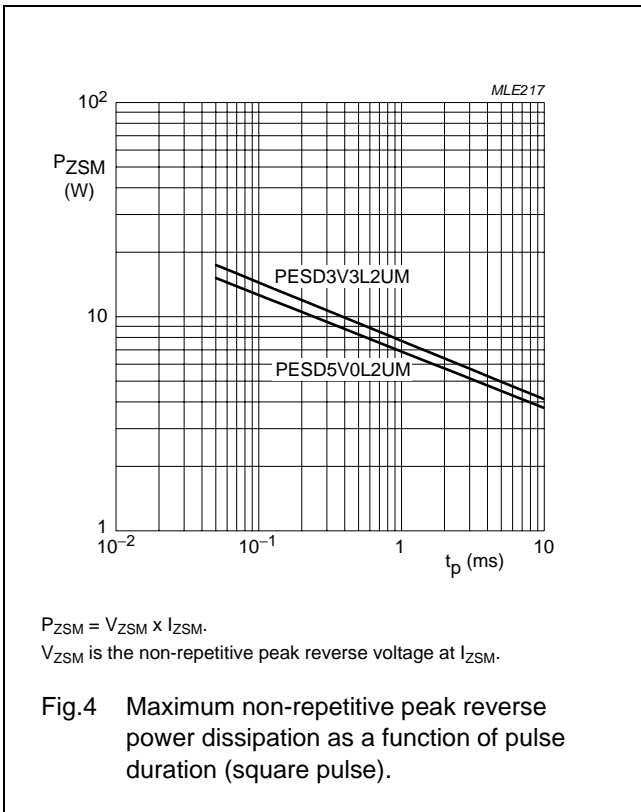
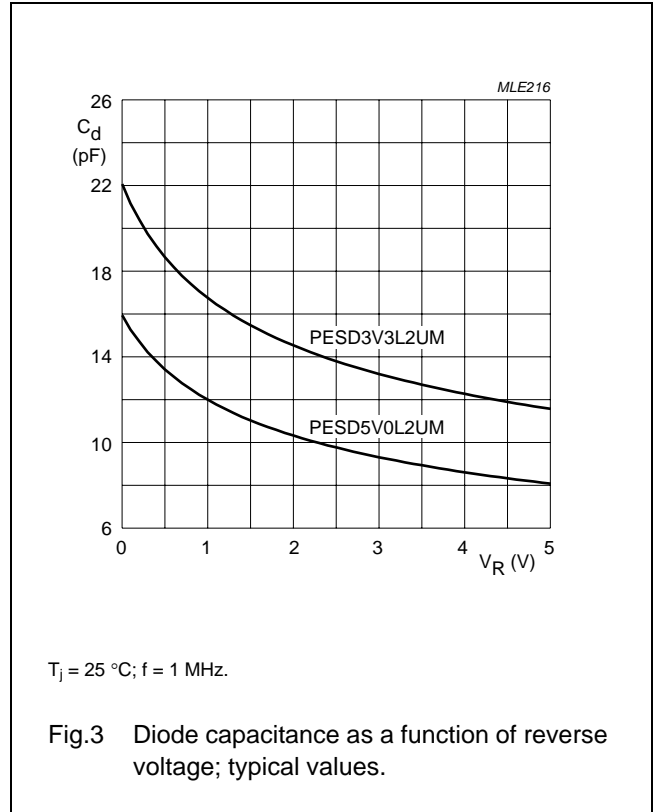
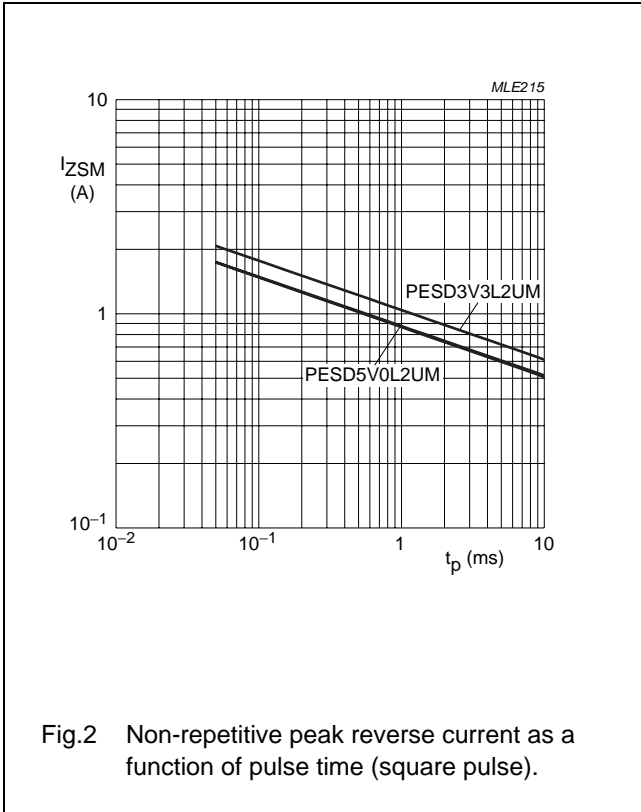

Low capacitance double ESD protection diode

PESDxL2UM series

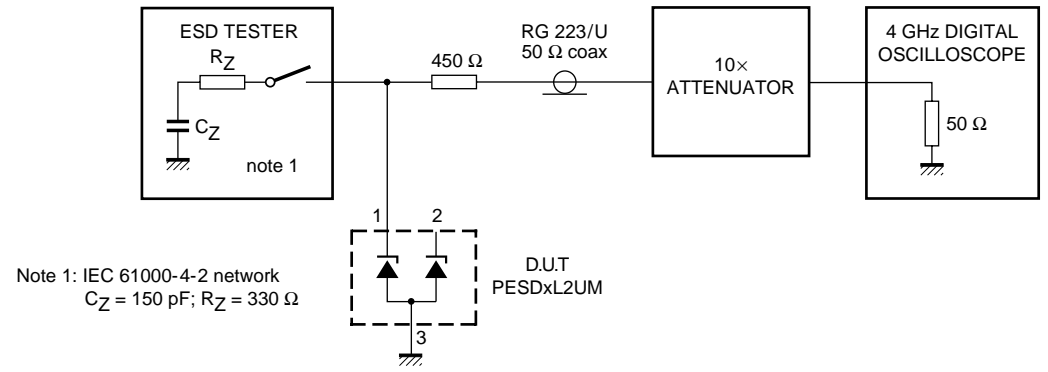

Note 1: IEC 61000-4-2 network
 $C_Z = 150 \text{ pF}$; $R_Z = 330 \text{ }\Omega$

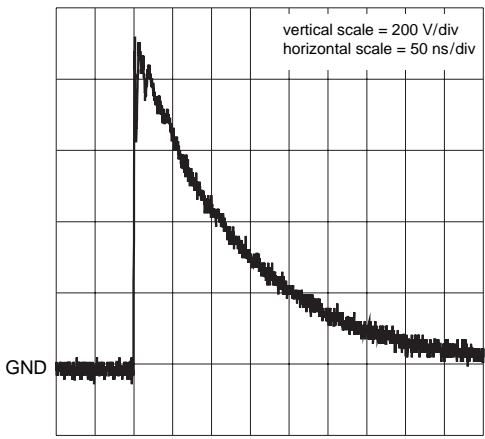

unclamped +1 kV ESD voltage waveform (IEC 61000-4-2 network)

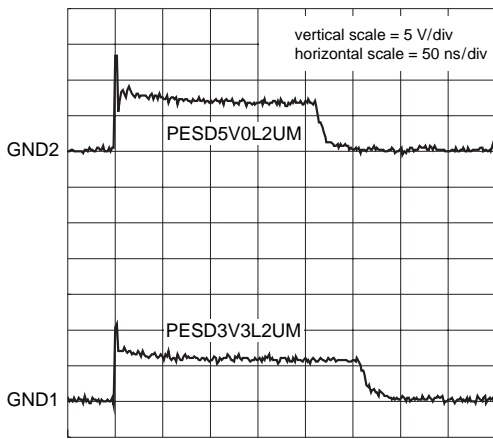

clamped +1 kV ESD voltage waveform (IEC 61000-4-2 network)

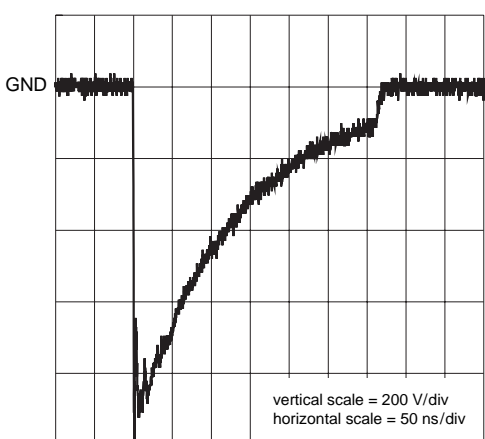

unclamped -1 kV ESD voltage waveform (IEC 61000-4-2 network)

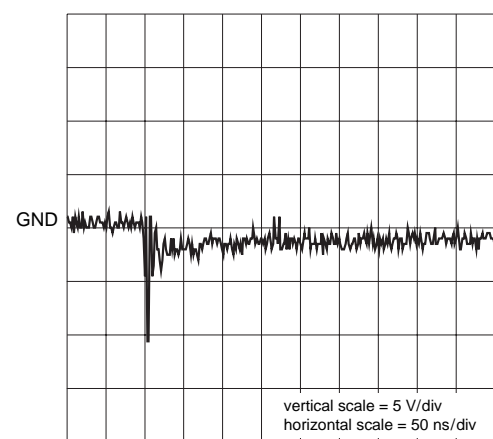

clamped -1 kV ESD voltage waveform (IEC 61000-4-2 network)

MLE219

Fig.6 ESD clamping test set-up and waveforms.

Low capacitance double ESD protection diode

PESDxL2UM series

PACKAGE OUTLINE

Leadless ultra small plastic package; 3 solder lands; body 1.0 x 0.6 x 0.5 mm

SOT883

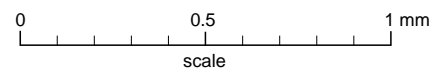
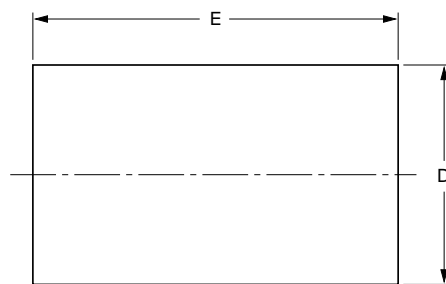
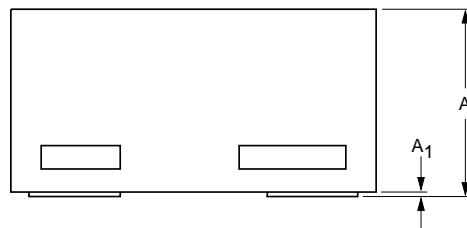
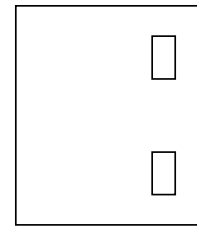
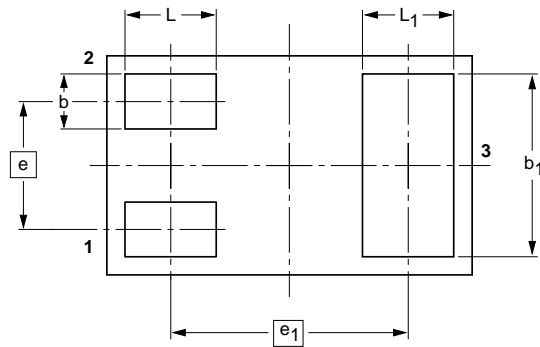

DIMENSIONS (mm are the original dimensions)

UNIT	A ⁽¹⁾	A ₁ max.	b	b ₁	D	E	e	e ₁	L	L ₁
mm	0.50 0.46	0.03	0.20 0.12	0.55 0.47	0.62 0.55	1.02 0.95	0.35	0.65	0.30 0.22	0.30 0.22

Note

1. Including plating thickness

OUTLINE VERSION	REFERENCES			EUROPEAN PROJECTION	ISSUE DATE
	IEC	JEDEC	JEITA		
SOT883			SC-101		03-02-05 03-04-03

Low capacitance double ESD protection diode

PESDxL2UM series

DATA SHEET STATUS

DOCUMENT STATUS ⁽¹⁾	PRODUCT STATUS ⁽²⁾	DEFINITION
Objective data sheet	Development	This document contains data from the objective specification for product development.
Preliminary data sheet	Qualification	This document contains data from the preliminary specification.
Product data sheet	Production	This document contains the product specification.

Notes

1. Please consult the most recently issued document before initiating or completing a design.
2. The product status of device(s) described in this document may have changed since this document was published and may differ in case of multiple devices. The latest product status information is available on the Internet at URL <http://www.nxp.com>.

DISCLAIMERS

General — Information in this document is believed to be accurate and reliable. However, NXP Semiconductors does not give any representations or warranties, expressed or implied, as to the accuracy or completeness of such information and shall have no liability for the consequences of use of such information.

Right to make changes — NXP Semiconductors reserves the right to make changes to information published in this document, including without limitation specifications and product descriptions, at any time and without notice. This document supersedes and replaces all information supplied prior to the publication hereof.

Suitability for use — NXP Semiconductors products are not designed, authorized or warranted to be suitable for use in medical, military, aircraft, space or life support equipment, nor in applications where failure or malfunction of an NXP Semiconductors product can reasonably be expected to result in personal injury, death or severe property or environmental damage. NXP Semiconductors accepts no liability for inclusion and/or use of NXP Semiconductors products in such equipment or applications and therefore such inclusion and/or use is at the customer's own risk.

Applications — Applications that are described herein for any of these products are for illustrative purposes only. NXP Semiconductors makes no representation or warranty that such applications will be suitable for the specified use without further testing or modification.

Limiting values — Stress above one or more limiting values (as defined in the Absolute Maximum Ratings System of IEC 60134) may cause permanent damage to the device. Limiting values are stress ratings only and operation of the device at these or any other conditions

above those given in the Characteristics sections of this document is not implied. Exposure to limiting values for extended periods may affect device reliability.

Terms and conditions of sale — NXP Semiconductors products are sold subject to the general terms and conditions of commercial sale, as published at <http://www.nxp.com/profile/terms>, including those pertaining to warranty, intellectual property rights infringement and limitation of liability, unless explicitly otherwise agreed to in writing by NXP Semiconductors. In case of any inconsistency or conflict between information in this document and such terms and conditions, the latter will prevail.

No offer to sell or license — Nothing in this document may be interpreted or construed as an offer to sell products that is open for acceptance or the grant, conveyance or implication of any license under any copyrights, patents or other industrial or intellectual property rights.

Export control — This document as well as the item(s) described herein may be subject to export control regulations. Export might require a prior authorization from national authorities.

Quick reference data — The Quick reference data is an extract of the product data given in the Limiting values and Characteristics sections of this document, and as such is not complete, exhaustive or legally binding.

NXP Semiconductors

Customer notification

This data sheet was changed to reflect the new company name NXP Semiconductors. No changes were made to the content, except for the legal definitions and disclaimers.

Contact information

For additional information please visit: **<http://www.nxp.com>**

For sales offices addresses send e-mail to: **salesaddresses@nxp.com**

© NXP B.V. 2009

All rights are reserved. Reproduction in whole or in part is prohibited without the prior written consent of the copyright owner.

The information presented in this document does not form part of any quotation or contract, is believed to be accurate and reliable and may be changed without notice. No liability will be accepted by the publisher for any consequence of its use. Publication thereof does not convey nor imply any license under patent- or other industrial or intellectual property rights.

Printed in The Netherlands

R76/02/pp9

Date of release: 2005 May 23

Document order number: 9397 750 15162



Looking for pricing, stock, or lifecycle information?

Click below to explore more details on WIN SOURCE:

- ⊖ [View PESD3V3L2UM,315 on WIN SOURCE](#)
- ⊖ [Nexperia USA Inc. Information](#)

Optimize Your Supply Chain with WIN SOURCE Solutions

- ✓ Global Sourcing Solution
- ✓ Obsolete Management
- ✓ Cost Control Management
- ✓ Shortage Management
- ✓ Alternative Solution
- ✓ Excess Inventory Management