



**THE DATASHEET OF  
SKY13453-385LF**



DATA SHEET

# SKY13453-385LF: 0.01 to 6.0 GHz Single Control SPDT Switch

## Applications

- Cellular pre-PA mode switches
- Dual-band WLANs (802.11a/b/g/n)

## Features

- Low insertion loss: 0.40 dB @ 2.0 GHz
- High isolation: >25 dB @ 2.0 GHz
- Single bit control
- Small QFN (6-pin, 1 x 1 mm) package (MSL1, 260 °C per JEDEC J-STD-020)



Skyworks Green™ products are compliant with all applicable legislation and are halogen-free. For additional information, refer to *Skyworks Definition of Green™*, document number SQ04-0074.

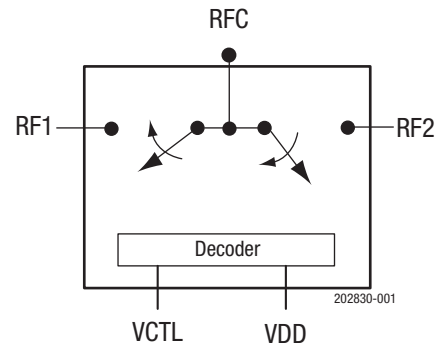

Figure 1. SKY13453-385LF Block Diagram

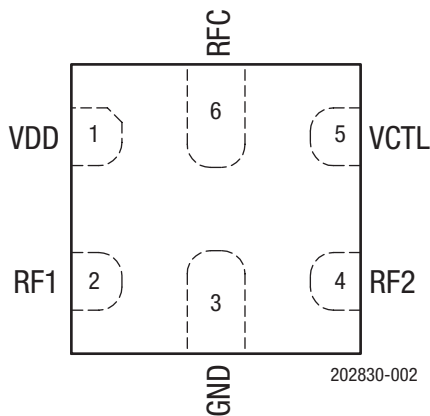

Figure 2. SKY13453-385LF Pinout (Top View)

## Description

The SKY13453-385LF is a single-pole, double-throw (SPDT) switch intended for mode switching in pre-power amplifier (PA) cellular or WLAN applications. Using advanced switching technologies, the SKY13453-385LF maintains low insertion loss and high isolation for all switching paths.

The high-linearity performance and low insertion loss achieved by the switch make it an ideal choice for mode switching before the PA in cellular applications. Depending on the logic voltage applied to the control pin (VCTL), the RFC pin is connected to one of the two switched RF outputs, RF1 or RF2, using a low insertion loss path, while the path between the RFC pin and the other RF path is in a high isolation state.

The switch is manufactured in a compact, 1 x 1 mm, 6-pin Quad Flat No-Lead (QFN) package. A functional block diagram is shown in Figure 1. The pin configuration and package are shown in Figure 2. Signal pin assignments and functional pin descriptions are provided in Table 1.

**Table 1. SKY13453-385LF Signal Descriptions**

Pin	Name	Description	Pin	Name	Description
1	VDD	Supply voltage	4	RF2	RF port 2. Must be DC blocked.
2	RF1	RF port 1. Must be DC blocked.	5	VCTL	DC control voltage
3	GND	Ground	6	RFC	RF common port. Must be DC blocked.

### Electrical and Mechanical Specifications

The absolute maximum ratings of the SKY13453-385LF are provided in Table 2. Electrical specifications are provided in Table 3.

The state of the SKY13453-385LF is determined by the logic provided in Table 4. A timing diagram is shown in Figure 3.

The typical performance characteristics for the SKY13453-385LF are shown in Figures 4 through 7.

**Table 2. SKY13453-385LF Absolute Maximum Ratings<sup>1</sup>**

Parameter	Symbol	Minimum	Maximum	Units
Supply voltage	VDD	2.5	3.7	V
Control voltage	VCTL	-0.2	+3.0	V
Input power	P <sub>IN</sub>		+33	dBm
Storage temperature	T <sub>STG</sub>	-40	+125	°C
Operating temperature	T <sub>OP</sub>	-40	+90	°C

<sup>1</sup> Exposure to maximum rating conditions for extended periods may reduce device reliability. There is no damage to device with only one parameter set at the limit and all other parameters set at or below their nominal value. Exceeding any of the limits listed here may result in permanent damage to the device.

---

**ESD HANDLING:** *Although this device is designed to be as robust as possible, electrostatic discharge (ESD) can damage this device. This device must be protected at all times from ESD when handling or transporting. Static charges may easily produce potentials of several kilovolts on the human body or equipment, which can discharge without detection. Industry-standard ESD handling precautions should be used at all times.*

---

**Table 3. SKY13453-385LF Electrical Specifications<sup>1</sup>**  
**(VDD = 2.8 V, VCTL = 1.8 V, T<sub>OP</sub> = +25 °C, P<sub>IN</sub> = 0 dBm, Characteristic Impedance [Z<sub>0</sub>] = 50 Ω, Unless Otherwise Noted)**

Parameter	Symbol	Test Condition	Min	Typ	Max	Units
<b>RF Specifications</b>						
Insertion loss (RFC to RF1/RF2 ports)	IL	0.01 to 1.0 GHz		0.40	0.55	dB
		1.0 to 2.0 GHz		0.40	0.55	dB
		2.0 to 3.0 GHz		0.45	0.60	dB
		4.8 to 6.0 GHz		0.70	0.85	dB
Isolation (RFC to RF1/RF2 ports)	Iso	0.01 to 1.0 GHz	25	27		dB
		1.0 to 2.0 GHz	25	27		dB
		2.0 to 3.0 GHz	22	24		dB
		4.8 to 6.0 GHz		15		dB
Return loss (RFC to RF1/RF2 ports)	IS111	0.01 to 3.0 GHz		23		dB
		4.8 to 6.0 GHz		29		dB
0.1 dB input compression point (RF1/RF2 ports)	IPO.1dB	0.7 to 6.0 GHz		+33		dBm
2 <sup>nd</sup> harmonics	2fo	P <sub>IN</sub> = +20 dBm:				
		0.8 to 2.7 GHz	+74	+85		dBc
3 <sup>rd</sup> harmonics	3fo	P <sub>IN</sub> = +20 dBm:				
		0.8 to 2.7 GHz	+75	+85		dBc
Third order input intercept point (RF1/RF2)	IIP3	P <sub>IN</sub> = +17 dBm/tone, Δf = 1 MHz:				
		2.450 GHz, 5.8 GHz	+50 +50	+57 +56		dBm dBm
Error vector magnitude	EVM	802.11a, 54 Mbps, P <sub>IN</sub> ≤ +27 dBm		2.5		%
		802.11g, 54 Mbps, P <sub>IN</sub> ≤ +27 dBm		2.5		%
Switching speed		@ 2.45 GHz:				
		50% VCTL to 10/90% RF on time		650		ns
		50% VCTL to 90/10% RF off time		650		ns
		10/90% RF rise time		500		ns
		90/10% RF fall time		500		ns
<b>DC Specifications</b>						
Control voltage:		Note 2				
Low	V <sub>CTL_L</sub>		0		0.45	V
High	V <sub>CTL_H</sub>		1.35	1.8	3.0	V
Supply voltage	VDD		2.5		3.5	V
Supply current	I <sub>DD</sub>	VDD = 3.7 V		3	10	μA
Control current	I <sub>CTL</sub>	VCTL = 1.8 V		1		μA
Leakage control current	I <sub>CTL_LKG</sub>	VCTL = 1.8 V, VDD = 0 V			0.5	μA

<sup>1</sup> Performance is guaranteed only under the conditions listed in this table

2 VCTL\_H should always be lower than or equal to VDD.

**Table 4. SKY13453-385LF Truth Table<sup>1</sup>**

VDD (Pin 1)	VCTL (Pin 5)	Insertion Loss Path
H	H	RFC to RF1
H	L	RFC to RF2

<sup>1</sup> "H" = +1.8 V to +3.0 V. "L" = 0 V to +0.45 V.  
 Any state other than described in this table places the switch into an undefined state.  
 An undefined state will not damage the device.

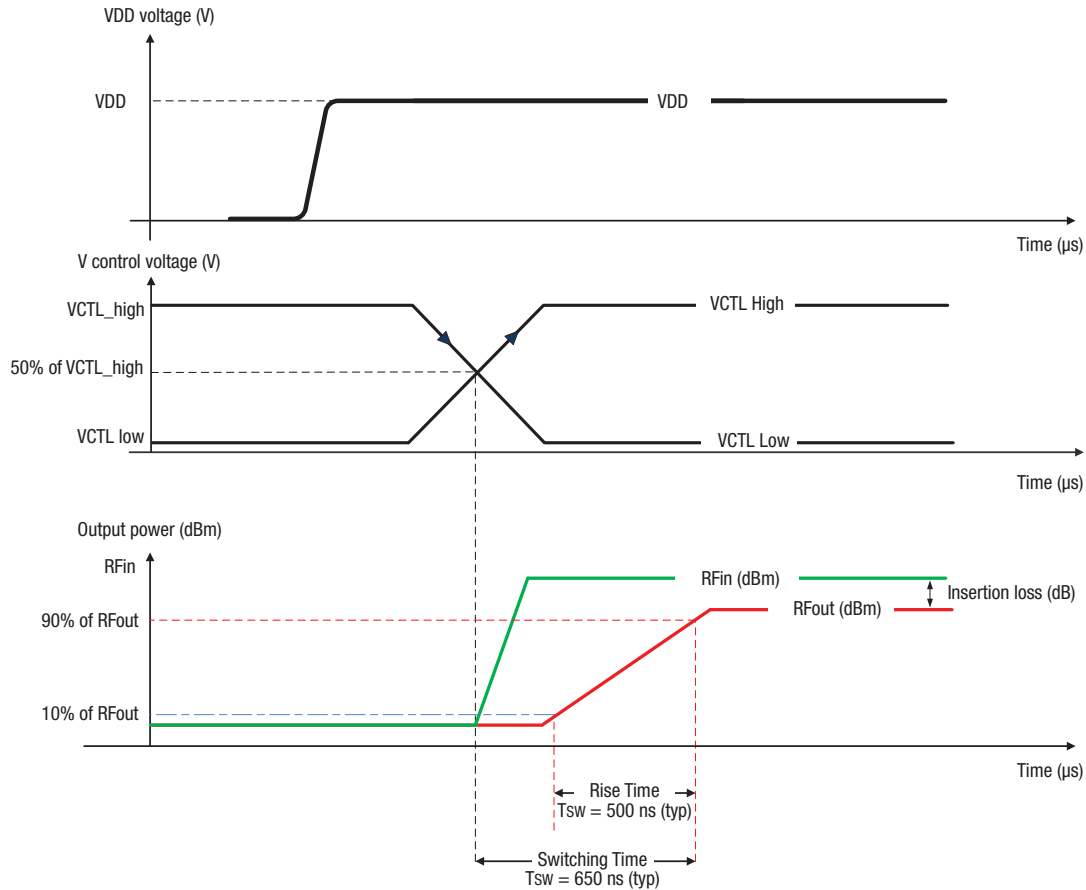

Scenario 1: Power-Up Sequence:

1. Set VDD
2. Set VCTL
3. Apply RF signal

Scenario 2: Power-Down Sequence:

1. Turn off RF signal
2. Turn off VCTL
3. Turn off VDD

Scenario 3: Switching Ports:

1. Turn off RF signal
2. Change VCTL state
3. Turn on RF signal

202830-003

**Figure 3. SKY13453-385LF Timing Diagram**

### Typical Performance Characteristics

( $V_{DD} = 2.8\text{ V}$ ,  $V_{CTL} = 1.8\text{ V}$ ,  $T_{OP} = +25\text{ }^{\circ}\text{C}$ ,  $P_{IN} = 0\text{ dBm}$ , Characteristic Impedance [ $Z_0$ ] =  $50\text{ }\Omega$ , Unless Otherwise Noted)

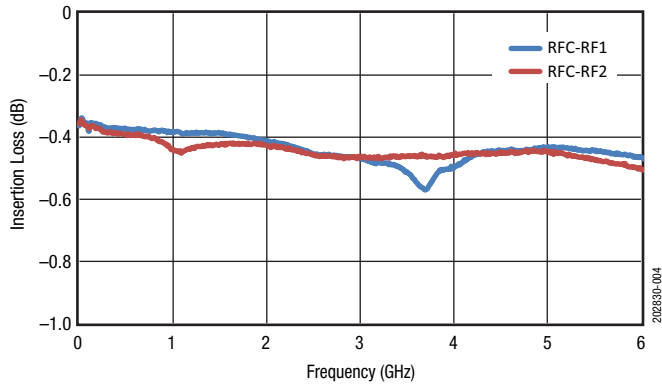

Figure 4. Insertion Loss vs Frequency

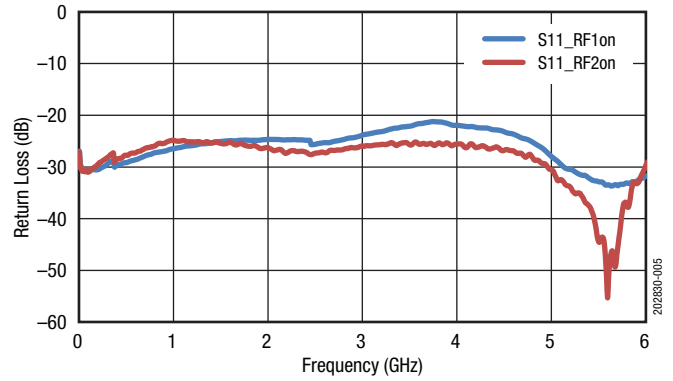

Figure 5. Return Loss vs Frequency

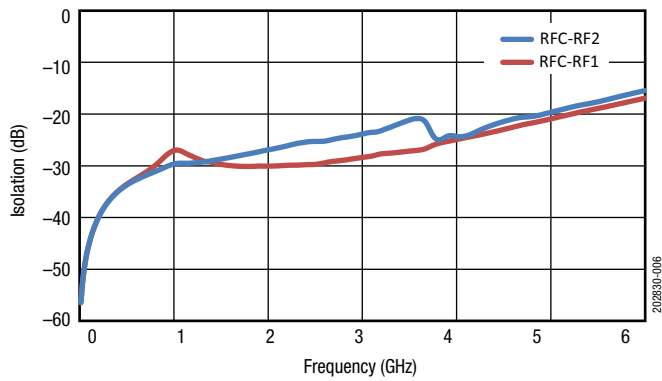

Figure 6. Isolation vs Frequency

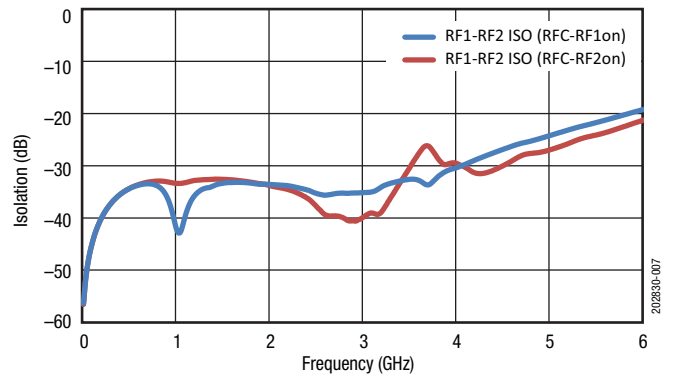

Figure 7. Isolation vs Frequency

### Evaluation Board Description

The SKY13453-385LF Evaluation Board is used to test the performance of the SKY13453-385LF SP2T Switch. An Evaluation Board schematic diagram is provided in Figure 8. An assembly drawing for the Evaluation Board is shown in Figure 9.

### Package Dimensions

The PCB layout footprint for the SKY13453-385LF is provided in Figure 10. Typical part markings are shown in Figure 11. Package dimensions are shown in Figure 12, and tape and reel dimensions are provided in Figure 13.

### Package and Handling Information

Instructions on the shipping container label regarding exposure to moisture after the container seal is broken must be followed. Otherwise, problems related to moisture absorption may occur when the part is subjected to high temperature during solder assembly.

The SKY13453-385LF is rated to Moisture Sensitivity Level 1 (MSL1) at 260 °C. It can be used for lead or lead-free soldering. It can be used for lead or lead-free soldering. For additional information, refer to the Skyworks Application Note, *Solder Reflow Information*, document number 200164.

Care must be taken when attaching this product, whether it is done manually or in a production solder reflow environment. Production quantities of this product are shipped in a standard tape and reel format.

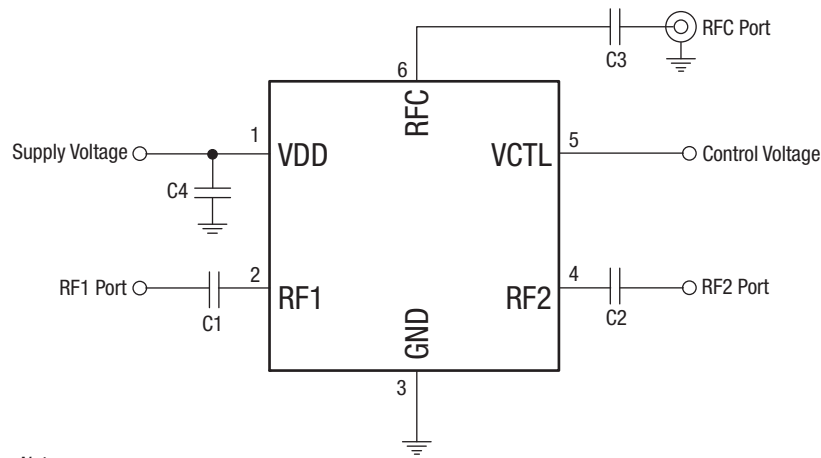

Notes:

C1, C2, and C3 = 10 nF for low frequency applications (less than 100 MHz)

C4 = 10 nF

202830-008

**Figure 8. SKY13453-385LF Evaluation Board Schematic**

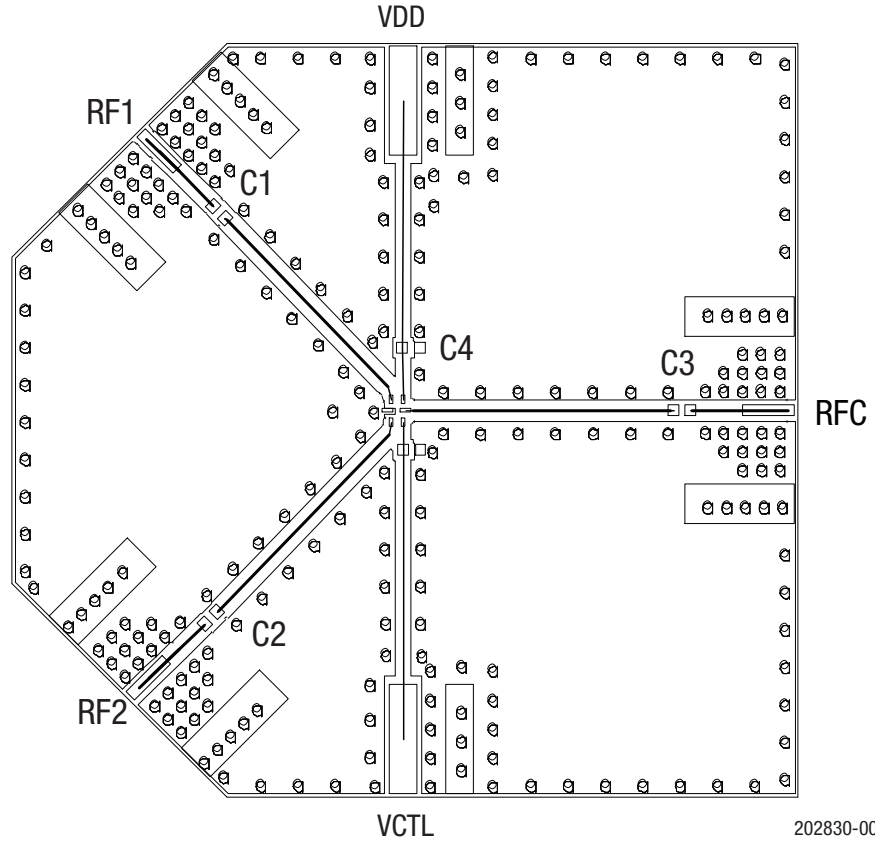

Figure 9. SKY13453-385LF Evaluation Board Assembly Diagram

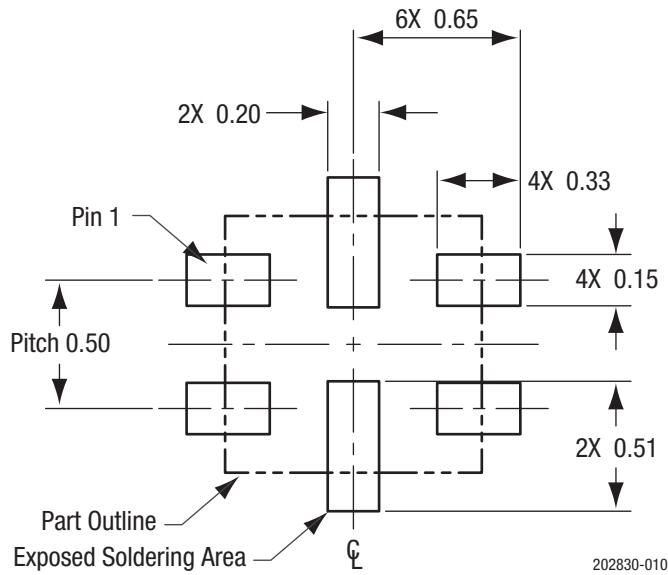
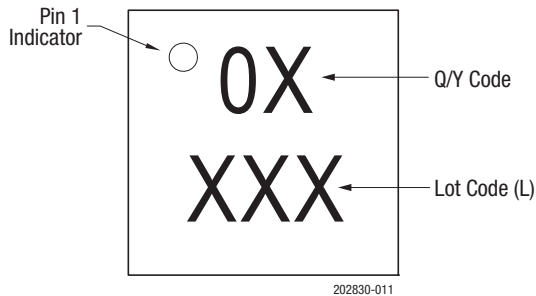
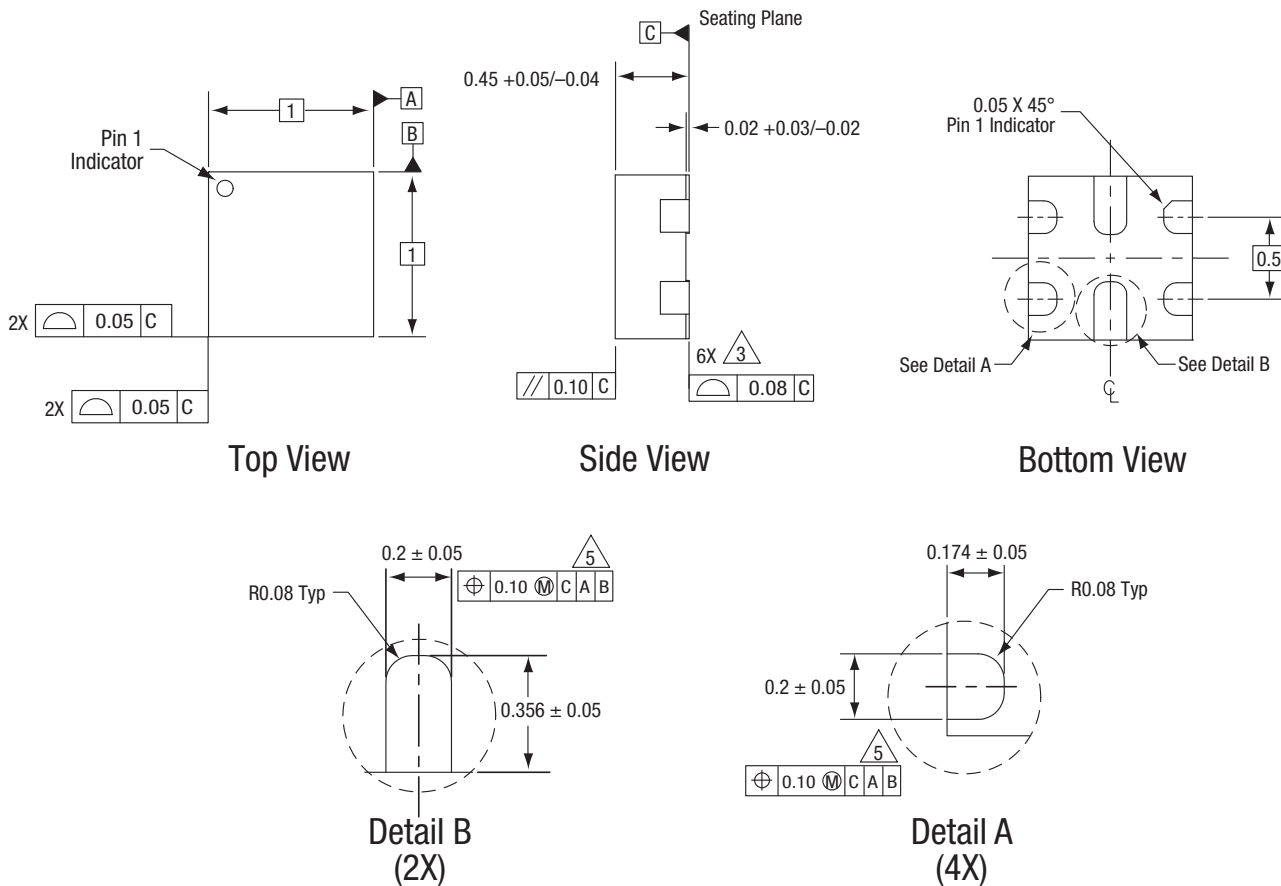

Figure 10. SKY13453-385LF PCB Layout Footprint (Top View)



**Figure 11. Typical Part Markings (Top View)**



**Notes:**

1. All measurements are in millimeters.
2. Dimensions and tolerances according to ASME Y14.5M-1994.

202830-012

**Figure 12. SKY13453-385LF Package Dimensions**

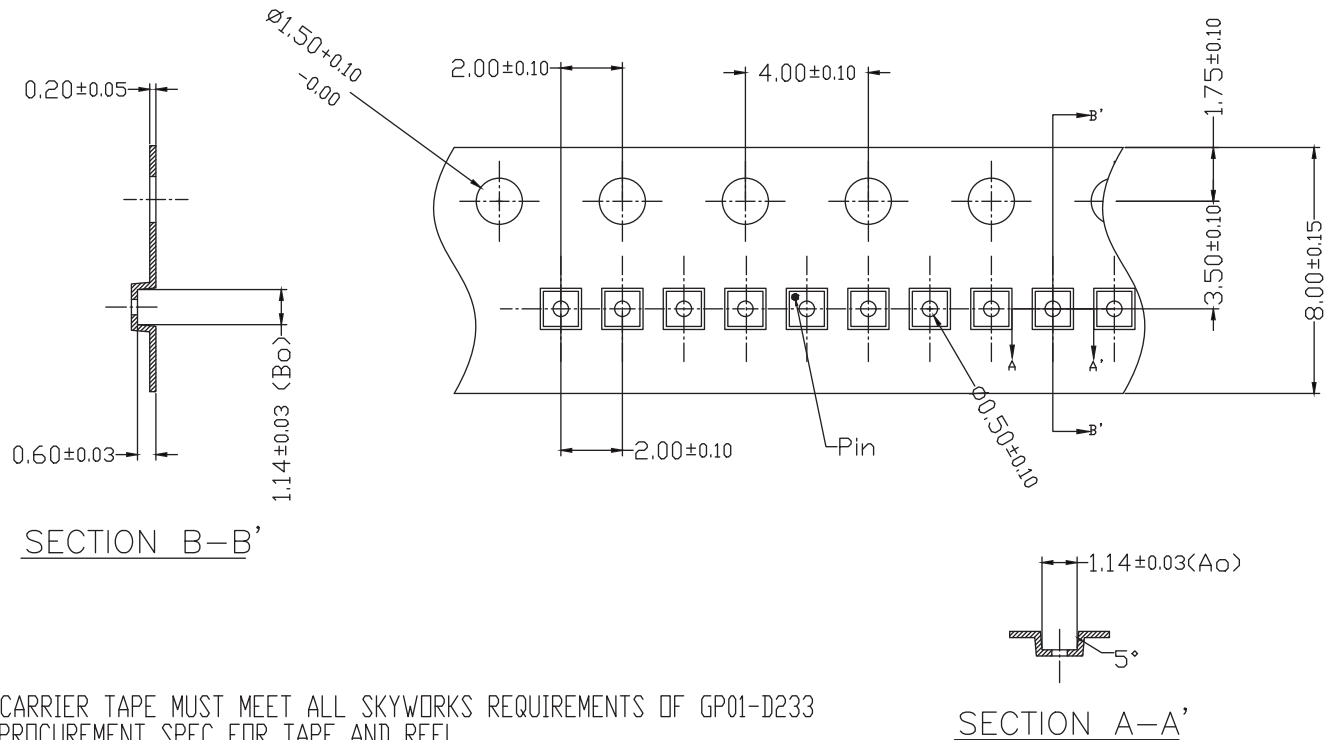

1. CARRIER TAPE MUST MEET ALL SKYWORKS REQUIREMENTS OF GP01-D233 PROCUREMENT SPEC FOR TAPE AND REEL
2. CARRIER TAPE SHALL BE BLACK CONDUCTIVE POLYCARBONATE.
3. COVER TAPE SHALL BE TRANSPARENT CONDUCTIVE MATERIAL
4. ESD-SURFACE RESISTIVITY SHALL MEET GP01-D233
5. 10 SPROCKET HOLE PITCH CUMULATIVE TOLERANCE :  $\pm 0.20\text{mm}$
6.  $A_o$  &  $B_o$  MEASURED ON PLANE  $0.30\text{mm}$  ABOVE THE BOTTOM OF THE POCKET.
7. ALL DIMENSIONS ARE IN MILLIMETERS.

SECTION A-A'

202830-013

**Figure 13. SKY13453-385LF Tape and Reel Dimensions**

## Ordering Information

Model Name	Manufacturing Part Number	Evaluation Board Part Number
SKY13453-385LF: SPDT Switch	SKY13453-385LF	SKY13453-385LF-EVB

Copyright © 2013, 2015-2017 Skyworks Solutions, Inc. All Rights Reserved.

Information in this document is provided in connection with Skyworks Solutions, Inc. (“Skyworks”) products or services. These materials, including the information contained herein, are provided by Skyworks as a service to its customers and may be used for informational purposes only by the customer. Skyworks assumes no responsibility for errors or omissions in these materials or the information contained herein. Skyworks may change its documentation, products, services, specifications or product descriptions at any time, without notice. Skyworks makes no commitment to update the materials or information and shall have no responsibility whatsoever for conflicts, incompatibilities, or other difficulties arising from any future changes.

No license, whether express, implied, by estoppel or otherwise, is granted to any intellectual property rights by this document. Skyworks assumes no liability for any materials, products or information provided hereunder, including the sale, distribution, reproduction or use of Skyworks products, information or materials, except as may be provided in Skyworks Terms and Conditions of Sale.

THE MATERIALS, PRODUCTS AND INFORMATION ARE PROVIDED “AS IS” WITHOUT WARRANTY OF ANY KIND, WHETHER EXPRESS, IMPLIED, STATUTORY, OR OTHERWISE, INCLUDING FITNESS FOR A PARTICULAR PURPOSE OR USE, MERCHANTABILITY, PERFORMANCE, QUALITY OR NON-INFRINGEMENT OF ANY INTELLECTUAL PROPERTY RIGHT; ALL SUCH WARRANTIES ARE HEREBY EXPRESSLY DISCLAIMED. SKYWORKS DOES NOT WARRANT THE ACCURACY OR COMPLETENESS OF THE INFORMATION, TEXT, GRAPHICS OR OTHER ITEMS CONTAINED WITHIN THESE MATERIALS. SKYWORKS SHALL NOT BE LIABLE FOR ANY DAMAGES, INCLUDING BUT NOT LIMITED TO ANY SPECIAL, INDIRECT, INCIDENTAL, STATUTORY, OR CONSEQUENTIAL DAMAGES, INCLUDING WITHOUT LIMITATION, LOST REVENUES OR LOST PROFITS THAT MAY RESULT FROM THE USE OF THE MATERIALS OR INFORMATION, WHETHER OR NOT THE RECIPIENT OF MATERIALS HAS BEEN ADVISED OF THE POSSIBILITY OF SUCH DAMAGE.



Skyworks products are not intended for use in medical, lifesaving or life-sustaining applications, or other equipment in which the failure of the Skyworks products could lead to personal injury, death, physical or environmental damage. Skyworks customers using or selling Skyworks products for use in such applications do so at their own risk and agree to fully indemnify Skyworks for any damages resulting from such improper use or sale.

Customers are responsible for their products and applications using Skyworks products, which may deviate from published specifications as a result of design defects, errors, or operation of products outside of published parameters or design specifications. Customers should include design and operating safeguards to minimize these and other risks. Skyworks assumes no liability for applications assistance, customer product design, or damage to any equipment resulting from the use of Skyworks products outside of stated published specifications or parameters.

Skyworks and the Skyworks symbol are trademarks or registered trademarks of Skyworks Solutions, Inc., in the United States and other countries. Third-party brands and names are for identification purposes only, and are the property of their respective owners. Additional information, including relevant terms and conditions, posted at [www.skyworksinc.com](http://www.skyworksinc.com), are incorporated by reference.

## Looking for pricing, stock, or lifecycle information?

Click below to explore more details on WIN SOURCE:

-  [View SKY13453-385LF on WIN SOURCE](#)
-  [Skyworks Solutions Inc. Information](#)

## Optimize Your Supply Chain with WIN SOURCE Solutions

-  Global Sourcing Solution
-  Obsolete Management
-  Cost Control Management
-  Shortage Management
-  Alternative Solution
-  Excess Inventory Management