



**THE DATASHEET OF
PE-65967NL**



T3/DS3/E3/STS-1 TRANSFORMERS

Designed for T3, DS3, E3 and STS-1 Interfaces

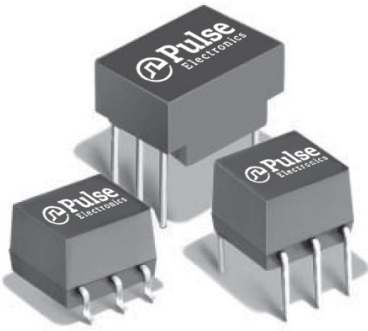

- RoHS peak reflow temperature rating: 245°C
- Return loss meets requirements of G.703
- Fast rise time compatible with standards
- Through hole and surface mount packages available
- UL recognized

Electrical Specifications @ 25°C - Operating Temperature 0°C to +70°C

RoHS Compliant Part Number	Turns Ratio (±2%)	OCL Primary (μH MIN)	OCL @ -40°C (μH MIN)	L _L (μH MAX)	C _{w/w} (pF MAX)	Bandwidth 75 System (MHzTYP)	Isolation Voltage (Vrms MIN)	Package/Schematic	Primary Pins
PE-65664NL	1:2CT	35	20	.12	10	-	1500	QC-1/B THT	2-6
PE-65779NL	1:4CT	150	-	.30	15	-	1500	QC-1/B THT	2-6
PE-65856NL	1:1.73CT	50	-	.10	12	.60-300	1500	LC-1/C THT	4-6
PE-65966NL	1:1	40	-	.10	10	.200-340	1500	LC-1/E THT	4-6
PE-65967NL	1:1	40	-	.10	10	.200-340	1500	LS-1/E SMT	4-6
PE-65968NL	1:2CT	19	-	.06	10	.250-500	1500	LS-1/C SMT	4-6
PE-65969NL	1:2CT	19	-	.06	10	.250-500	1500	LC-1/C THT	4-6
PE-68629NL	1:1	40	-	.10	5	-	3000	HC-1/A THT	1-5

Electrical Specifications @ 25°C

RoHS Compliant Part Number	Turns Ratio (Pri:Sec ±5%)	OCL @ 25°C (mH MIN)	C _{w/w} (mH MIN)	L _L (μH MAX)	DCR Pri (Ω MAX)	DCR Sec (Ω MAX)	Isolation Voltage (Vrms MIN)	Package/Schematic	Primary Pins
PE-64934NL	1:1	1.20	25	0.50	0.70	0.70	1500	HC-1/IS	1-2

Packaging Information

Package	Type	Part Weight	Parts/Tube	Parts/Reel	Reel Diameter	Tape Width	Pitch
LS-1	SMT	0.6 grams	70	600	13 inches	24mm	16mm
LC-1	THT	0.6 grams	65	-	-	-	-
HC-1	THT	1.2 grams	60	-	-	-	-
QC-1	THT	0.8 grams	60	-	-	-	-

USA 858 674 8100

Germany 49 7032 7806 0

Singapore 65 6287 8998

Shanghai 86 21 62787060

China 86 755 33966678

Taiwan 886 3 4356768

T3/DS3/E3/STS-1 TRANSFORMERS

Designed for T3, DS3, E3 and STS-1 Interfaces



Mechanicals

Schematics

QC-1

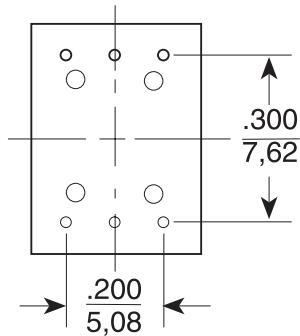
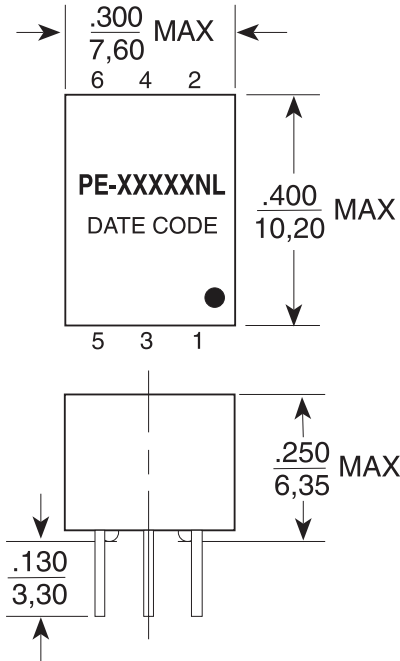

Leads are 22 AWG solderable.

Dimensions: $\frac{\text{Inches}}{\text{mm}}$ Unless otherwise specified, all tolerances are $\pm \frac{.010}{0,25}$

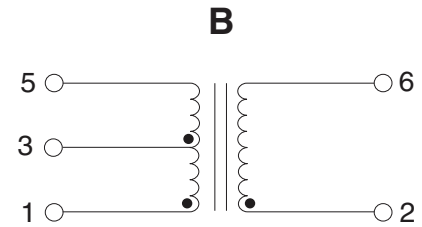

LC-1

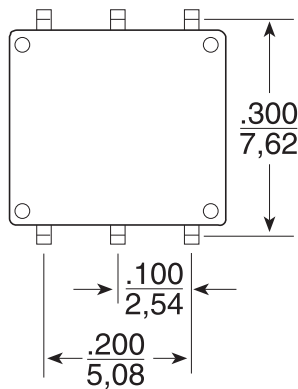
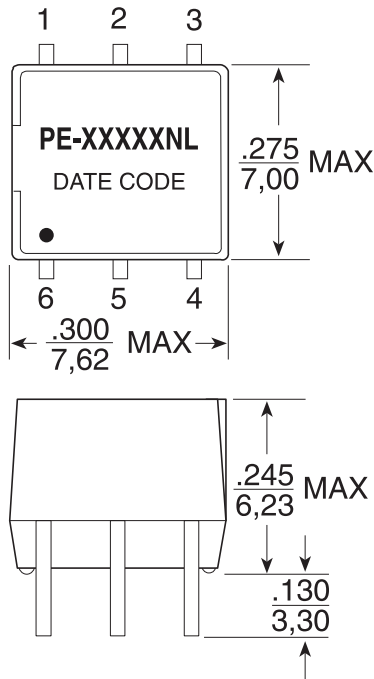

Leads are: $.010$ (0,25) X $.020$ (0,51) solderable.

Dimensions: $\frac{\text{Inches}}{\text{mm}}$ Unless otherwise specified, all tolerances are $\pm \frac{.010}{0,25}$

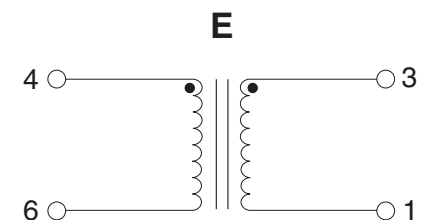
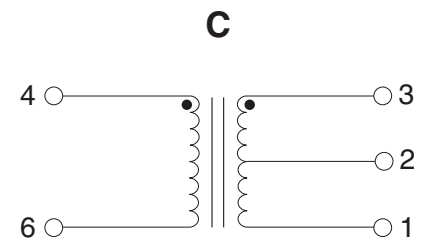

T3/DS3/E3/STS-1 TRANSFORMERS

Designed for T3, DS3, E3 and STS-1 Interfaces



Mechanicals

Schematics

HC-1

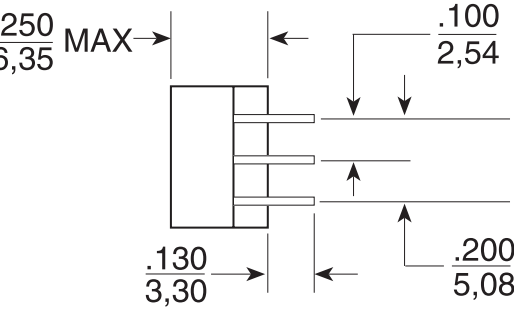
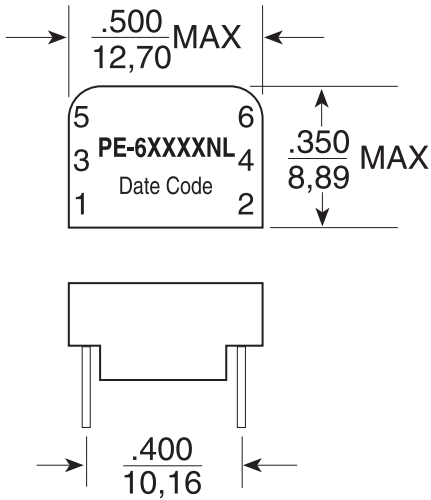

Notes: Leads are 24 AWG solderable.
 Unused pins not provided.

Dimensions: $\frac{\text{Inches}}{\text{mm}}$ Unless otherwise specified, all tolerances are $\pm \frac{.010}{0,25}$

A

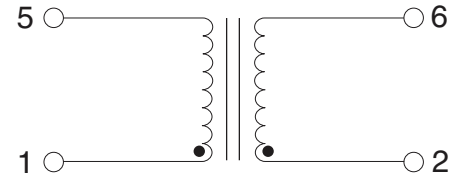

1S

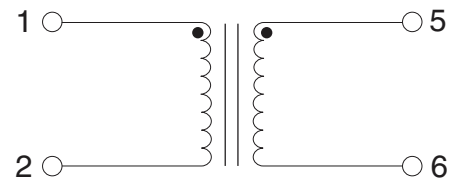

LS-1

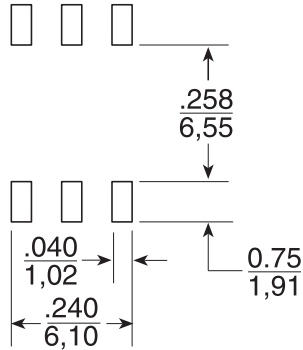
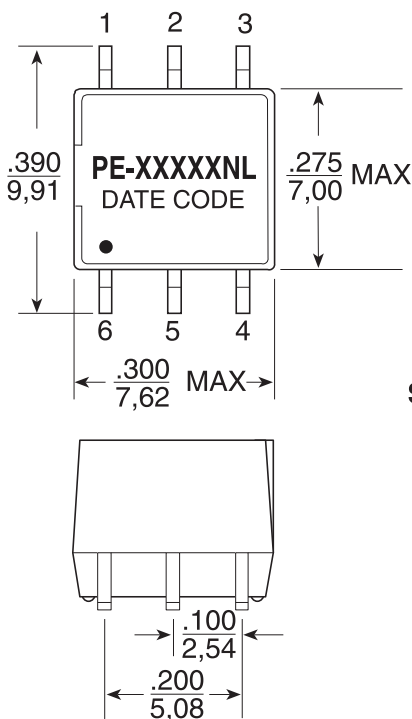

SUGGESTED PAD LAYOUT

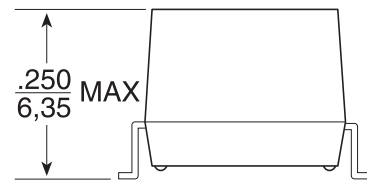

Dimensions: $\frac{\text{Inches}}{\text{mm}}$ Unless otherwise specified, all tolerances are $\pm \frac{.010}{0,25}$

C

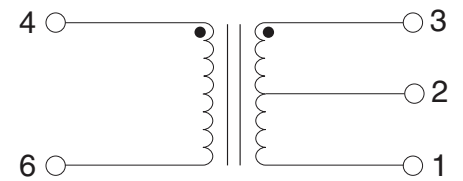

E

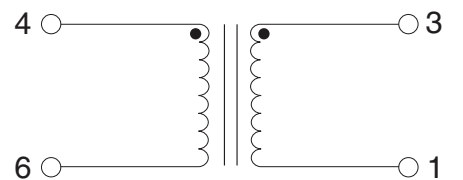

T3/DS3/E3/STS-1 TRANSFORMERS

Designed for T3, DS3, E3 and STS-1 Interfaces

Transformer Selection Guide							
Chip Manufacturer	IC	Surface Mount		Through Hole (1500 VRMS)		Through Hole (3000 VRMS)	
		Transmit	Receive	Transmit	Receive	Transmit	Receive
Lucent	T7296	PE-65967NL	-	PE-65966NL	-	PE-68629NL	-
Exar	XR-T7296	PE-65967NL	-	PE-65966NL	-	PE-68629NL	-
Silicon Systems	SSI 78P236, DS3	PE-65968NL	PE-65967NL	PE-65969NL	PE-65966NL	-	PE-68629NL
	SSI 78P7200, DS3	PE-65968NL	PE-65967NL	PE-65969NL	PE-65966NL	-	PE-68629NL
	SSI 78P7200, E3	PE-65968NL	PE-65968NL	PE-65969NL	PE-65966NL	-	-
	SSI 78P2361, STS-1	PE-65968NL	PE-65967NL	PE-65969NL	PE-65966NL	-	PE-68629NL
	SSI 78P2362, E3	PE-65968NL	PE-65967NL	PE-65969NL	PE-65966NL	-	PE-68629NL
Transwitch	MRT TXC-02050 E3	PE-65968NL	PE-65967NL	PE-65969NL	PE-65966NL	-	PE-68629NL
	ART 02020 DS3, STS-1	PE-65967NL	PE-65967NL	PE-65966NL	PE-65966NL	PE-68629NL	PE-68629NL

Application Notes

- The transformers have been developed for use as transmit and receive transformers in T3 or DS3 links, using bit rates of 44.736 Mbps and B3ZS coding on coaxial cable. The characteristics allow compliance with the Pulse templates of CCITT G.703 as well as ATT T.A.34. The transformers are also suitable for E3 interfacing at 34.368 Mbps with HDB3 coding or STS-1 applications, at 51.84 Mbps according to Bellcore TA-NWT-000253. The LC-1 and QC-1 packages are pin-compatible with T1-1 and T4-1 6-pin DIP packages.
- Bandwidth specifications are typical in a 75 Ω system. Return loss meets the requirements of G.703. Materials used in the products are UL94-VO recognized. Products meet the requirements of IEC 695-2-2 (Needle Flame Test).
- The surface mount LS-1 package is available with optional Tape & Reel packaging. To order, add a "T" suffix to the part number (e.g. PE-65967NL^T).
- The Transwitch MRT TXC-02050 chip is also designed to operate in 6.312 and 8.448 Mbps interfaces. A 1:1 transformer (PE-64934) is recommended.

For More Information

Pulse Worldwide Headquarters
12220 World Trade Drive
San Diego, CA
92128
U.S.A.

Tel: 858 674 8100
Fax: 858 674 8262

Pulse Europe
Einsteinstrasse 1
D-71083 Herrenberg
Germany

Tel: 49 7032 78060
Fax: 49 7032 7806 135

Pulse China Headquarters
B402, Shenzhen Academy of
Aerospace Technology Bldg.
10th Kejinan Road
High-Tech Zone
Nanshan District
Shenzhen, PR China
518057
Tel: 86 755 33966678
Fax: 86 755 33966700

Pulse North China
Room 2704/2705
Super Ocean Finance
Ctr.
2067 Yan An Road
West
Shanghai 200336
China
Tel: 86 21 62787060
Fax: 86 2162786973

Pulse South Asia
135 Joo Seng Road
#03-02
PM Industrial Bldg.
Singapore 368363
Tel: 65 6287 8998
Fax: 65 6287 8998

Pulse North Asia
3F, No. 198
Zhongyuan Road
Zhongli City
Taoyuan County 320
Taiwan R. O. C.
Tel: 886 3 4356768
Fax: 886 3 4356823 (Pulse)
Fax: 886 3 4356820 (FRE)

Performance warranty of products offered on this data sheet is limited to the parameters specified. Data is subject to change without notice. Other brand and product names mentioned herein may be trademarks or registered trademarks of their respective owners. © Copyright, 2012. Pulse Electronics, Inc. All rights reserved.

Looking for pricing, stock, or lifecycle information?

Click below to explore more details on WIN SOURCE:

 [View PE-65967NL on WIN SOURCE](#)

 [Pulse Information](#)

Optimize Your Supply Chain with WIN SOURCE Solutions

-  Global Sourcing Solution
-  Obsolete Management
-  Cost Control Management
-  Shortage Management
-  Alternative Solution
-  Excess Inventory Management