



**THE DATASHEET OF
PE4259-63**



Product Description

The PE4259 UltraCMOS® RF switch is designed to cover a broad range of applications from 10 MHz through 3000 MHz. This reflective switch integrates on-board CMOS control logic with a low voltage CMOS-compatible control interface, and can be controlled using either single-pin or complementary control inputs. Using a nominal +3-volt power supply voltage, a typical input 1dB compression point of +33.5 dBm can be achieved.

The PE4259 is manufactured on pSemi's UltraCMOS process, a patented variation of silicon-on-insulator (SOI) technology on a sapphire substrate, offering the performance of GaAs with the economy and integration of conventional CMOS.

**SPDT High Power UltraCMOS®
10 MHz–3.0 GHz RF Switch**

Features

- Single-pin or complementary CMOS logic control inputs
- Low insertion loss:
 - 0.35 dB @ 1000 MHz
 - 0.5 dB @ 2000 MHz
- Isolation of 30 dB @ 1000 MHz
- High ESD tolerance of 2 kV HBM
- Typical input 1 dB compression point of +33.5 dBm
- 1.8V minimum power supply voltage
- Ultra-small SC-70 package

Figure 1. Functional Diagram

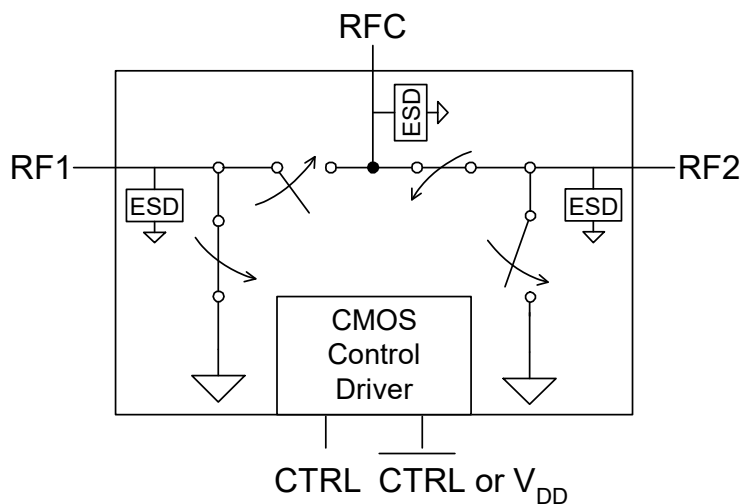

DOC-02109

**Figure 2. Package Type SC-70
6-lead SC-70**



Table 1. Electrical Specifications @ +25 °C, $V_{DD} = 3V$ ($Z_S = Z_L = 50\Omega$)

Parameter	Condition	Minimum	Typical	Maximum	Unit
Operation frequency ¹		10		3000	MHz
Insertion loss ³	1000 MHz		0.35	0.45	dB
	2000 MHz		0.50	0.60	dB
Isolation	1000 MHz	29	30		dB
	2000 MHz	19	20		dB
Return loss ³	1000 MHz	21	22		dB
	2000 MHz	24	27		dB
'ON' switching time	50% CTRL to 0.1 dB of final value, 1 GHz		1.50		us
'OFF' switching time	50% CTRL to 25 dB isolation, 1 GHz		1.50		us
Video feedthrough ²			15		mV _{pp}
Input 1dB compression point	1000 MHz @ 2.3–3.3V	31.5	33.5		dBm
	1000 MHz @ 1.8–2.3V	29.5	30.5		dBm
	2500 MHz @ 2.3–3.3V	28.5	30.5		dBm
	2500 MHz @ 1.8–2.3V	28	29		dBm
Input IP3	1000 MHz, 20 dBm input power		55		dBm

- Notes:
1. Device linearity will begin to degrade below 10 MHz.
 2. The DC transient at the output of any port of the switch when the control voltage is switched from Low to High or High to Low in a 50Ω test set-up, measured with 1ns risetime pulses and 500 MHz bandwidth.
 3. A tuning capacitor must be added to the application board to optimize the insertion loss and return loss performance. See *Figure 6* for details.

Figure 3. Pin Configuration (Top View)

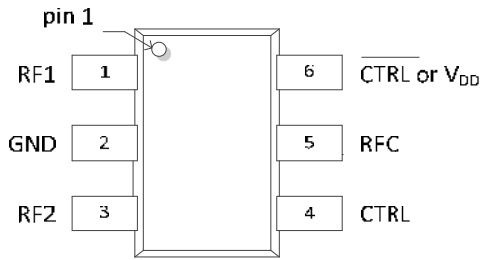

Table 2. Pin Descriptions

Pin No.	Pin Name	Description
1	RF1*	RF port 1.
2	GND	Ground connection. Traces should be physically short and connected to ground plane for best performance.
3	RF2 ¹	RF port 2.
4	CTRL	Switch control input, CMOS logic level.
5	RFC ¹	RF common.
6	$\overline{\text{CTRL}}$ or V_{DD}	This pin supports two interface options: <i>Single-pin control mode.</i> A nominal 3-volt supply connection is required. <i>Complementary-pin control mode.</i> A complementary CMOS control signal to CTRL is supplied to this pin. Bypassing on this pin is not required in this mode.

Note: * All RF pins must be DC blocked with an external series capacitor or held at 0 VDC.

Table 3. Operating Ranges

Parameter	Min	Typ	Max	Unit
V_{DD} Power supply voltage	1.8	3.0	3.3	V
I_{DD} Power supply current ($V_{\text{DD}} = 3\text{V}$, $V_{\text{CNTL}} = 3\text{V}$)		9	20	μA
Control voltage high	$0.7 \times V_{\text{DD}}$			V
Control voltage low			$0.3 \times V_{\text{DD}}$	V

Moisture Sensitivity Level

The Moisture Sensitivity Level rating for the PE4259 in the SC70 package is MSL1.

Switching Frequency

The PE4259 has a maximum 25 kHz switching rate.

Table 4. Absolute Maximum Ratings

Symbol	Parameter/Condition	Min	Max	Unit
V_{DD}	Power supply voltage	-0.3	4.0	V
V_{I}	Voltage on any DC input	-0.3	$V_{\text{DD}} + 0.3$	V
T_{ST}	Storage temperature range	-65	150	$^{\circ}\text{C}$
T_{OP}	Operating temperature range	-40	85	$^{\circ}\text{C}$
P_{IN}	Input power (50 Ω)		+34*	dBm
V_{ESD}	ESD Voltage (HBM, ML_STD 883 Method 3015.7)		2000	V
	ESD Voltage (MM, JEDEC, JESD22-A114-B)		100	V

Note: * To maintain optimum device performance, do not exceed Max P_{IN} at desired operating frequency (see Figure 4).

Exceeding absolute maximum ratings may cause permanent damage. Operation should be restricted to the limits in the Operating Ranges table. Operation between operating range maximum and absolute

Figure 4. Maximum Input Power

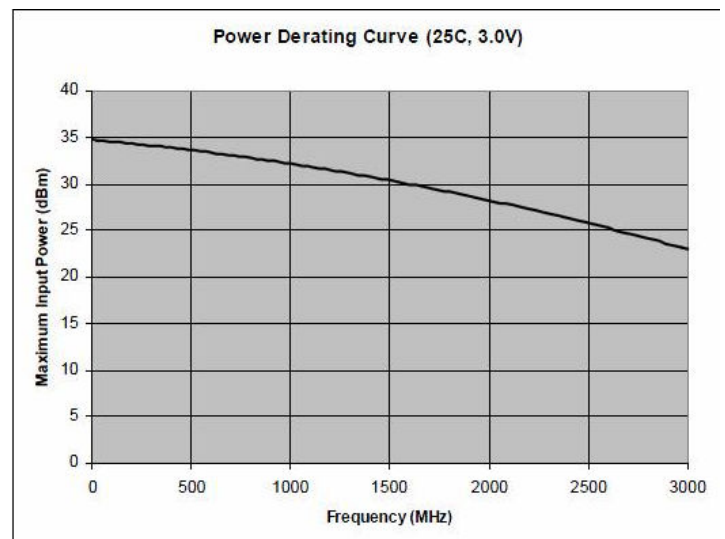

Latch-Up Avoidance

Unlike conventional CMOS devices, UltraCMOS devices are immune to latch-up.

Electrostatic Discharge (ESD) Precautions

When handling this UltraCMOS device, observe the same precautions that you would use with other ESD-sensitive devices. Although this device contains circuitry to protect it from damage due to ESD, precautions should be taken to avoid exceeding the specified rating.

Table 5. Single-pin Control Logic Truth Table

Control Voltages	Signal Path
Pin 6 (V_{DD}) = V_{DD} Pin 4 (CTRL) = High	RFC to RF1
Pin 6 (V_{DD}) = V_{DD} Pin 4 (CTRL) = Low	RFC to RF2

Table 6. Complementary-pin Control Logic Truth Table

Control Voltages	Signal Path
Pin 6 (\overline{CTRL} or V_{DD}) = Low Pin 4 (CTRL) = High	RFC to RF1
Pin 6 (\overline{CTRL} or V_{DD}) = High Pin 4 (CTRL) = Low	RFC to RF2

Thermal Data

Psi-JT (Ψ_{JT}), junction top-of-package, is a thermal metric to estimate junction temperature of a device on the customer application PCB (JEDEC JESD51-2).

$$\Psi_{JT} = (T_J - T_T)/P$$

Where

Ψ_{JT} = junction-to-top of package characterization parameter, °C/W

T_J = die junction temperature, °C

T_T = package temperature (top surface, in the center), °C

Table 7. Thermal Data

Parameter	Typ	Unit
Maximum junction temperature, T_{JMAX} (RF input power, CW = 31.5 dBm, +85 °C ambient)	99	°C
Ψ_{JT}	37	°C/W
θ_{JA} , junction-to-ambient thermal resistance	104	°C/W

Control Logic Input

The PE4259 is a versatile RF CMOS switch that supports two operating control modes; single-pin control mode and complementary-pin control mode.

Single-pin control mode enables the switch to operate with a single control pin (pin 4) supporting a +3-volt CMOS logic input, and requires a dedicated +3-volt power supply connection on pin 6 (V_{DD}). This mode of operation reduces the number of control lines required and simplifies the switch control interface typically derived from a CMOS μ Processor I/O port.

Complementary-pin control mode allows the switch to operate using complementary control pins CTRL and \overline{CTRL} (pins 4 and 6), that can be directly driven by +3-volt CMOS logic or a suitable μ Processor I/O port. This enables the PE4259 to be used as a potential alternate source for SPDT RF switch products used in positive control voltage mode and operating within the PE4259 operating limits.

Evaluation Kit

The SPDT switch EK Board was designed to ease customer evaluation of pSemi's PE4259. The RF common port is connected through a 50 Ω transmission line via the top SMA connector, J1. RF1 and RF2 are connected through 50 Ω transmission lines via SMA connectors J2 and J3, respectively. A through 50 Ω transmission is available via SMA connectors J4 and J5. This transmission line can be used to estimate the loss of the PCB over the environmental conditions being evaluated.

The board is constructed of a two metal layer FR4 material with a total thickness of 0.031". The bottom layer provides ground for the RF transmission lines. The transmission lines were designed using a coplanar waveguide with ground plane model using a trace width of 0.0476", trace gaps of 0.030", dielectric thickness of 0.028", metal thickness of 0.0021" and ϵ_r of 4.4.

J6 and J7 provide a means for controlling DC and digital inputs to the device. J6-1 is connected to the device V_{DD} or \overline{CTRL} input. J7-1 is connected to the device CTRL input.

Figure 5. Evaluation Board Layout

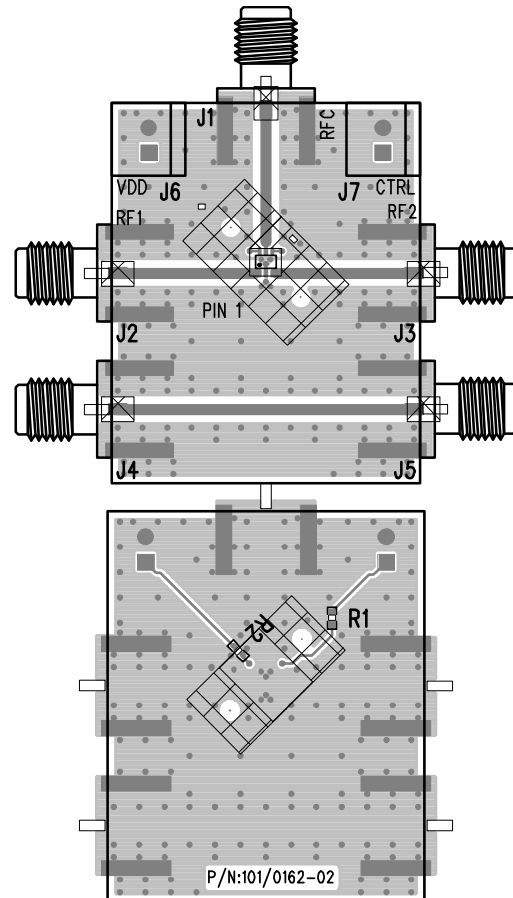

DOC-02396

Figure 6. Evaluation Board Schematic

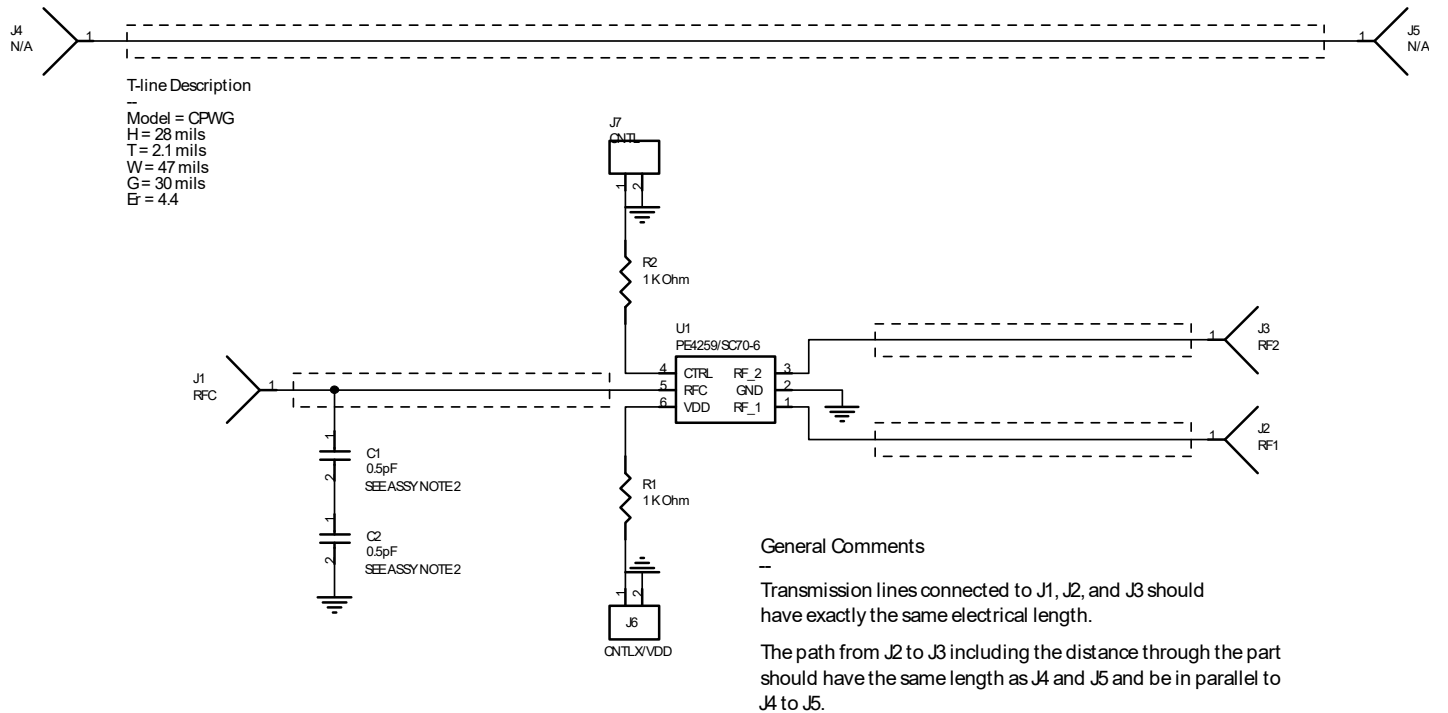

NOTES

1. USE PCB PART NUMBER 101-0162-02.
2. ADD TWO 0.5PF CAPS IN SERIES TO BE SHUNTED ON THE J1 SMA INPUT.
 SOLDER C1 SIDE 1 TO THE RF TRACE CLOSE TO THE J1 PIN.
 SOLDER C1 SIDE 2 TO C2 SIDE 1.
 SOLDER C2 SIDE 2 TO GROUND.

DOC-30626

Typical Performance Data @ $V_{DD} = 3V$, $T = -40\text{ }^{\circ}C$ to $85\text{ }^{\circ}C$ (Unless Otherwise Noted)

Figure 7. Insertion Loss

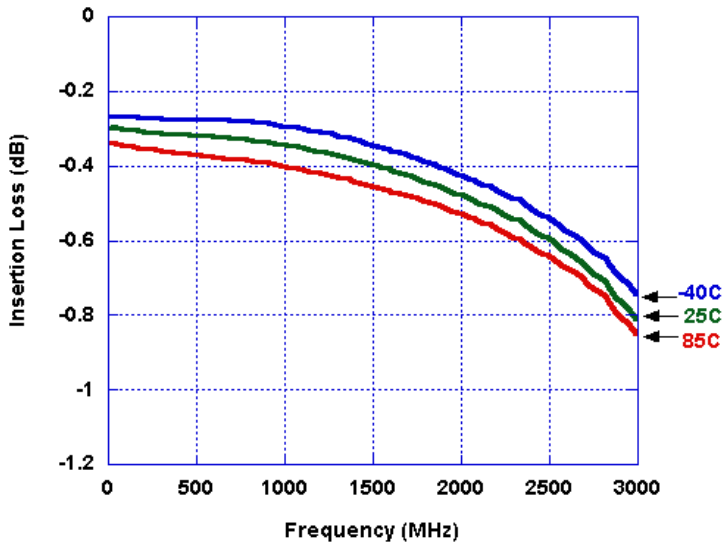

Figure 8. Isolation – Input to Output

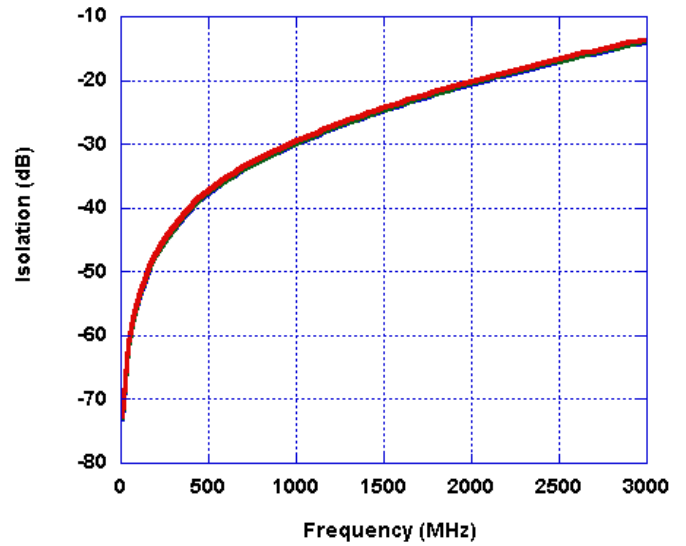

Figure 9. Isolation – Output to Output

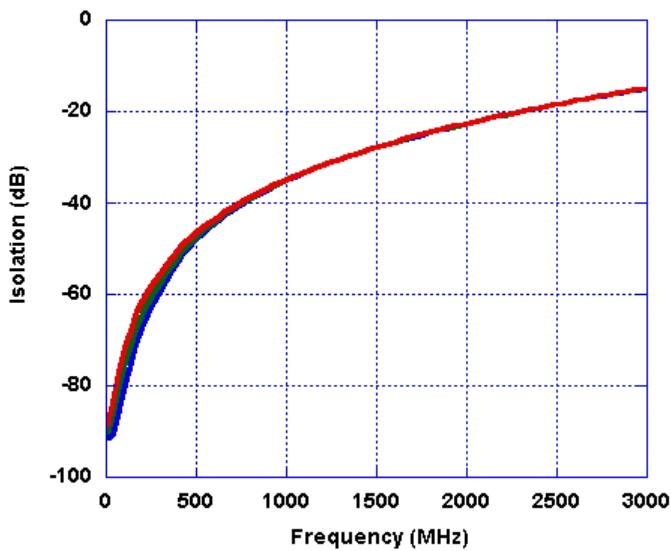
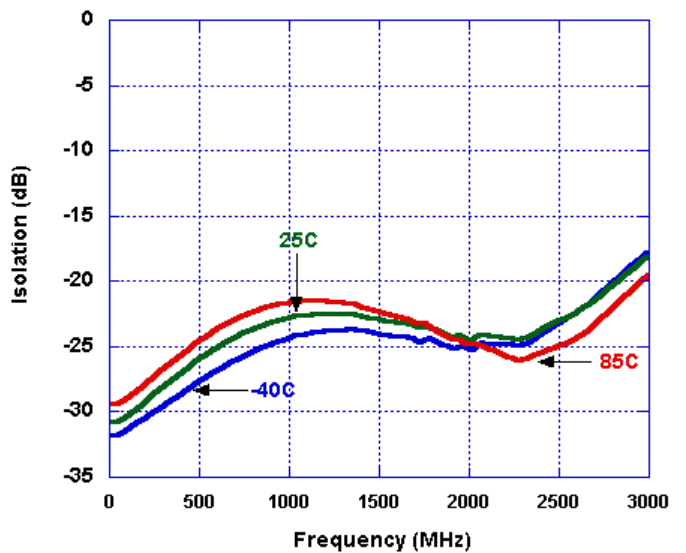

Figure 10. Return Loss (Input)



Typical Performance Data @ $V_{DD} = 2.3V$, $T = 25\text{ }^{\circ}C$

Figure 11. Insertion Loss

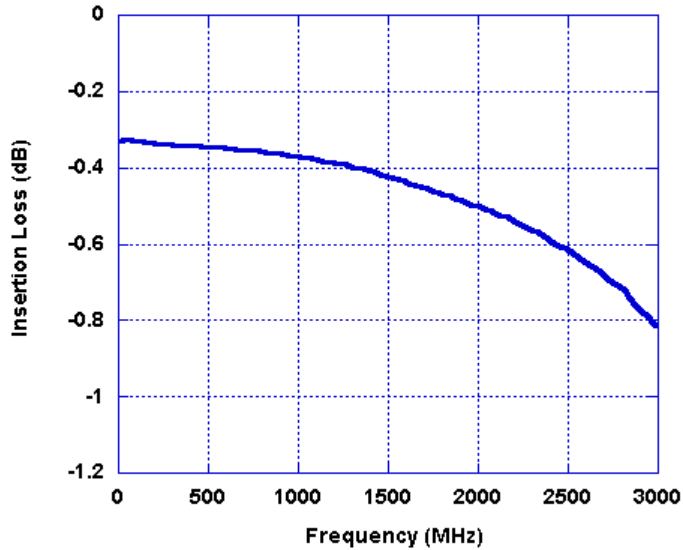

Figure 12. Isolation – Input to Output

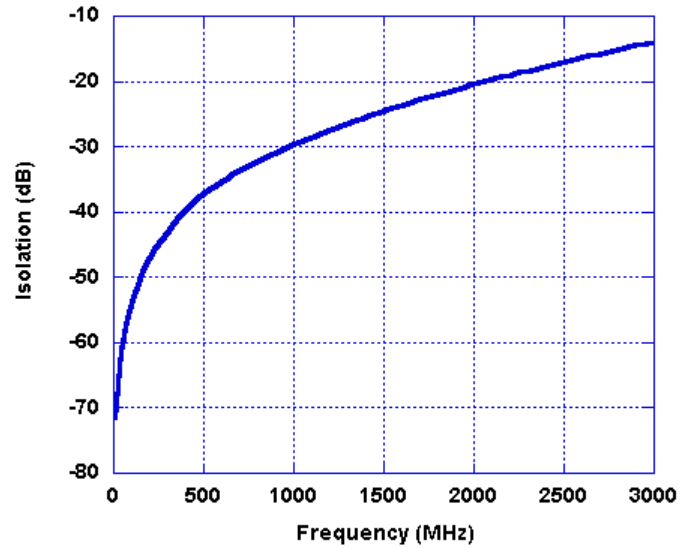

Figure 13. Isolation – Output to Output

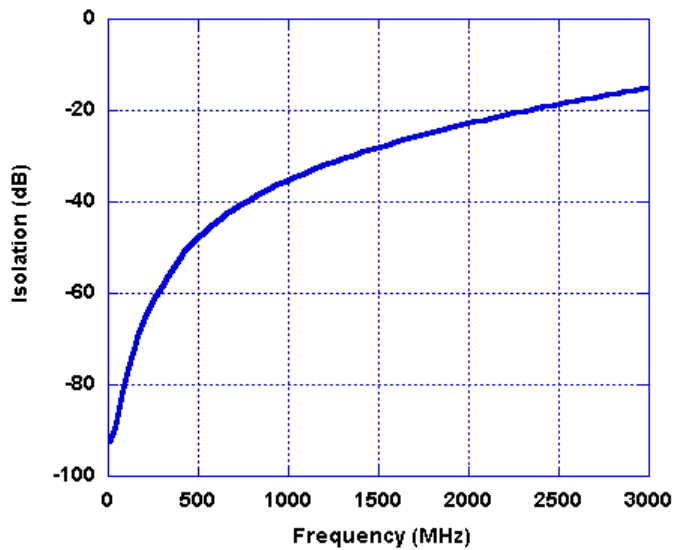

Figure 14. Return Loss (Input and Output)

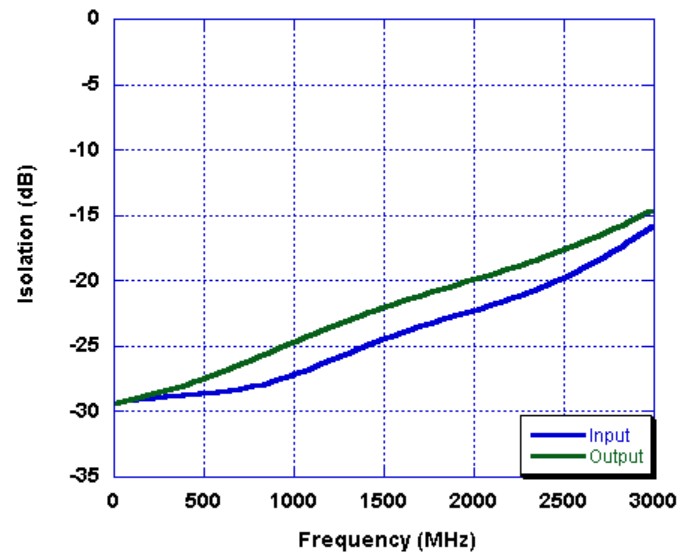

Figure 15. Package Drawing
6-lead SC-70

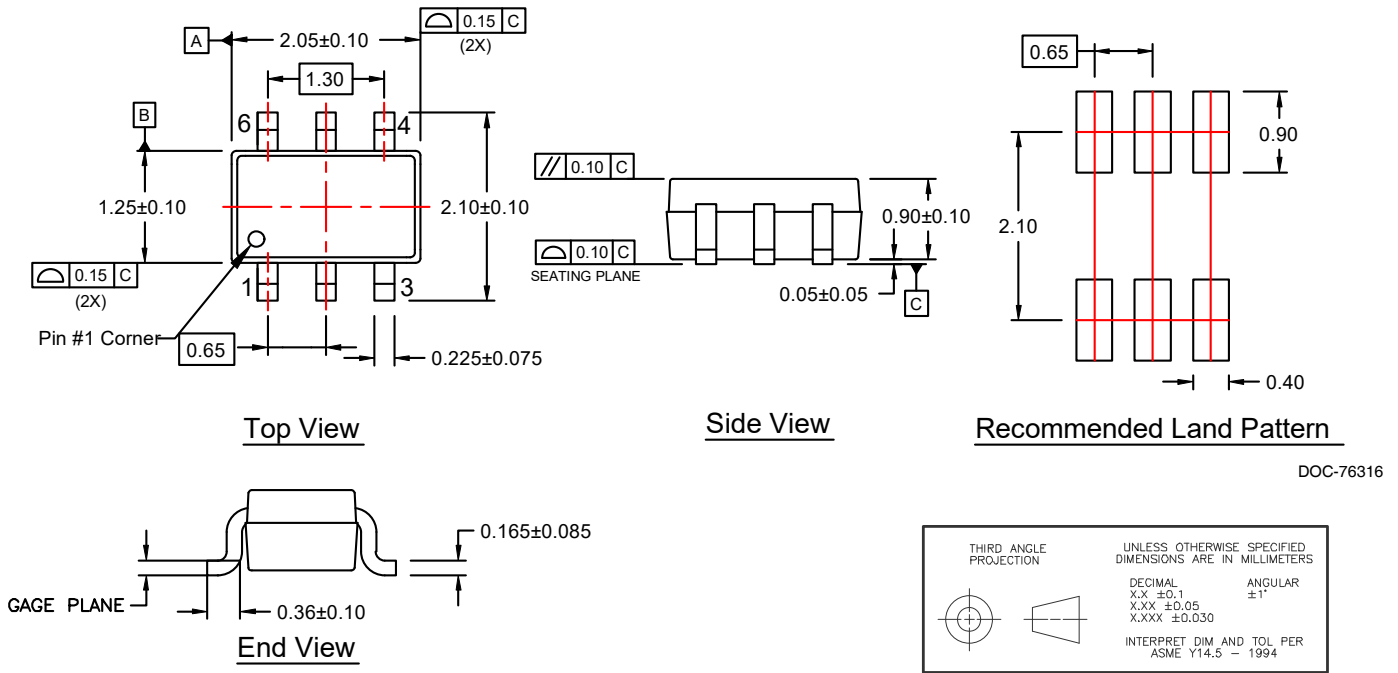
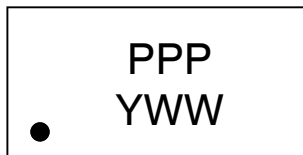

Figure 16. Top Marking Specifications



PRT-50103

- = Pin 1 Indicator
- PPP = Last 3 Digits of Part Number
- YWW = Date Code

Figure 16. Tape and Reel Specifications

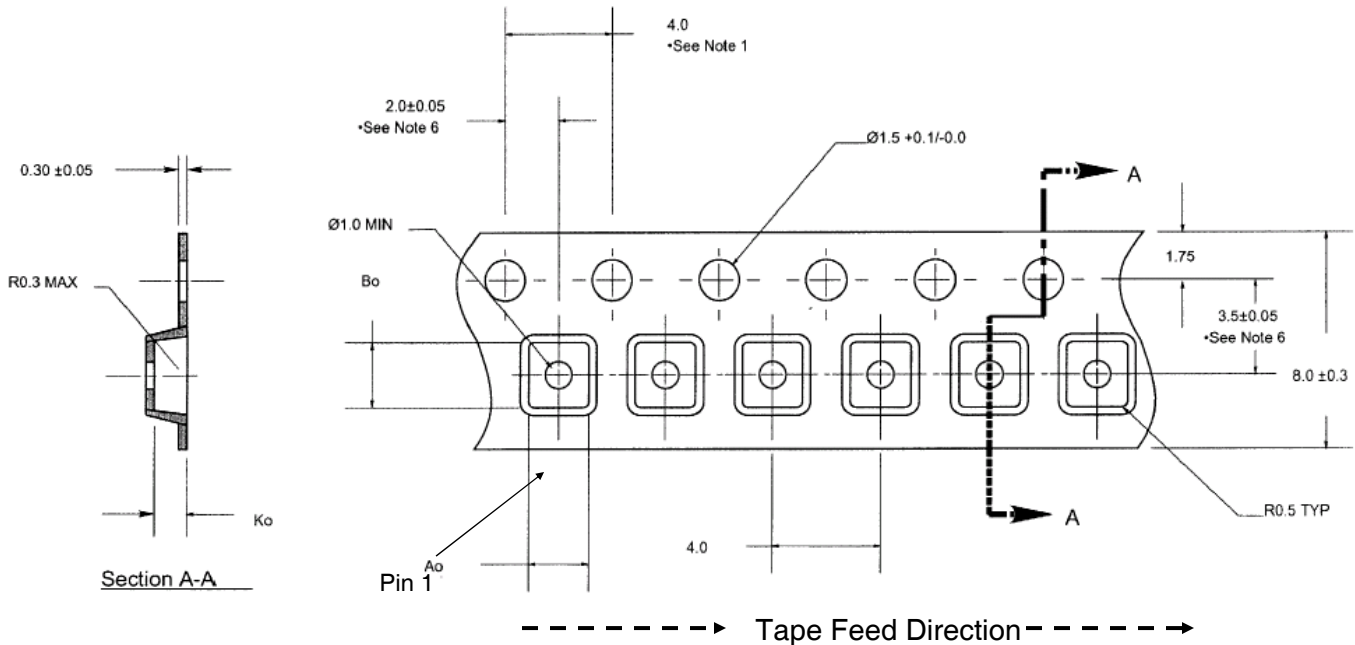

Notes:

1. 10 sprocket hole pitch cumulative tolerance ± 0.02 .
2. Camber not to exceed 1mm in 100mm.
3. Material: Black Conductive Advantek Polystyrene.
4. A_o and B_o measured on a plane 0.3mm above the bottom of the pocket
5. K_o measured from a plane on the inside bottom of the pocket to the top surface of the carrier.
6. Pocket position relative to sprocket hole measured as true position of pocket, not pocket hole.

$A_o = 2.25$ mm
 $B_o = 2.4$ mm
 $K_o = 1.2$ mm

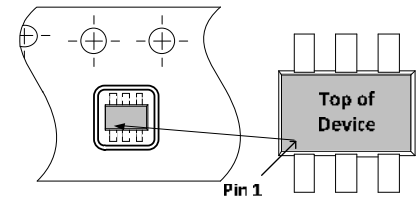

Device Orientation in Tape

Table 7. Ordering Information

Order Code	Part Marking	Description	Package	Shipping Method
4259-63	259	PE4259G-06SC70-3000C	Green 6-lead SC-70	3000 units / T&R
EK4259-01	PE4259-EK	PE4259-06SC70-EK	Evaluation Kit	1 / Box

Sales Contact and Information



For sales and contact information please visit www.psemi.com.

Advance Information: The product is in a formative or design stage. The datasheet contains design target specifications for product development. Specifications and features may change in any manner without notice.
Preliminary Specification: The datasheet contains preliminary data. Additional data may be added at a later date. pSemi reserves the right to change specifications at any time without notice in order to supply the best possible product.
Product Specification: The datasheet contains final data. In the event pSemi decides to change the specifications, pSemi will notify customers of the intended changes by issuing a CNF (Customer Notification Form).
 The information in this document is believed to be reliable. However, pSemi assumes no liability for the use of this information. Use shall be entirely at the user's own risk.

No patent rights or licenses to any circuits described in this document are implied or granted to any third party. pSemi's products are not designed or intended for use in devices or systems intended for surgical implant, or in other applications intended to support or sustain life, or in any application in which the failure of the pSemi product could create a situation in which personal injury or death might occur. pSemi assumes no liability for damages, including consequential or incidental damages, arising out of the use of its products in such applications.
 The Peregrine Semiconductor name, Peregrine Semiconductor logo and UltraCMOS are registered trademarks and the pSemi name, pSemi logo, HaRP and DuNE are trademarks of pSemi Corporation in the U.S. and other countries.
 pSemi products are protected under one or more of the following U.S. patents: patents.psemi.com.

Looking for pricing, stock, or lifecycle information?

Click below to explore more details on WIN SOURCE:

-  [View PE4259-63 on WIN SOURCE](#)
-  [Peregrine Semiconductor](#) Information

Optimize Your Supply Chain with WIN SOURCE Solutions

-  Global Sourcing Solution
-  Obsolete Management
-  Cost Control Management
-  Shortage Management
-  Alternative Solution
-  Excess Inventory Management