



THE DATASHEET OF IR928-6C-F





Technical Data Sheet

1.5mm Side Face Infrared LED

IR928-6C-F

Features

- High reliability
- High radiant intensity
- Peak wavelength $\lambda_p=940\text{nm}$
- 2.54mm Lead spacing
- Low forward voltage
- Pb.Free
- This product itself will remain within RoHS compliant version.



Descriptions

- EVERLIGHT's Infrared Emitting Diode (IR928-6C-F) is a high intensity diode, molded in a water clear plastic package.
- The miniature side-facing device has a chip, that emits radiation from the side of the clear package.

Applications

- Mouse
- Optoelectronic switch
- Infrared applied system

Device Selection Guide

LED Part No.	Chip	Lens Color
	Material	
IR928-6C-F	GaAlAs	Water clear

Package Dimensions

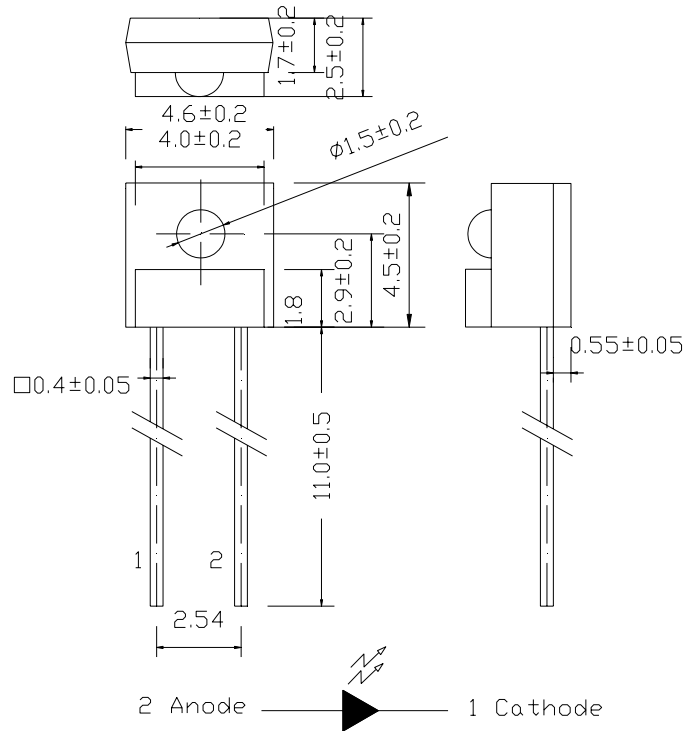

- Notes:** 1.All dimensions are in millimeters
 2.Tolerances unless dimensions $\pm 0.25\text{mm}$

Absolute Maximum Ratings (Ta=25°C)

Parameter	Symbol	Rating	Units
Continuous Forward Current	I_F	50	mA
Peak Forward Current(*1)	I_{FP}	1.0	A
Reverse Voltage	V_R	5	V
Operating Temperature	T_{opr}	-25 ~ +85	°C
Storage Temperature	T_{stg}	-40 ~ +85	°C
Soldering Temperature(*2)	T_{sol}	260	°C
Power Dissipation at(or below) 25°C Free Air Temperature	P_d	75	mW

- Notes:** *1: I_{FP} Conditions--Pulse Width $\leq 100 \mu s$ and Duty $\leq 1\%$.
 *2:Soldering time ≤ 5 seconds.

Electro-Optical Characteristics (Ta=25°C)

Parameter	Symbol	Condition	Min.	Typ.	Max.	Units
Light Current	Ic(ON)	I _F =4mA, V _{CE} =3.5V	265	--	1870	μA
Peak Wavelength	λ _p	I _F =20mA	--	940	--	nm
Spectral Bandwidth	Δλ	I _F =20mA	--	50	--	nm
Forward Voltage	V _F	I _F =20mA	--	1.2	1.5	V
Reverse Current	I _R	V _R =5V	--	--	10	μA
View Angle	2θ 1/2	I _F =20mA	--	40	--	deg

Wide Rank

Parameter	Symbol	Min	Max	Unit	Test Condition
5-2	Ic(ON)	1053	1870	μA	I _F =4mA, V _{CE} =3.5V
6-1	Ic(ON)	650	1274	μA	I _F =4mA, V _{CE} =3.5V
6-2	Ic(ON)	465	750	μA	I _F =4mA, V _{CE} =3.5V
7-1	Ic(ON)	347	550	μA	I _F =4mA, V _{CE} =3.5V
7-2	Ic(ON)	306	441	μA	I _F =4mA, V _{CE} =3.5V
7-3	Ic(ON)	265	358	μA	I _F =4mA, V _{CE} =3.5V

Thin Rank

Color Code	Ranks	Symbol	Min	Max	Unit	Test Condition
Yellow	E3	Ic(ON)	286	431	μA	I _F =4mA, V _{CE} =3.5V
Silver	E4	Ic(ON)	357	519	μA	I _F =4mA, V _{CE} =3.5V
Green	E5	Ic(ON)	428	608	μA	I _F =4mA, V _{CE} =3.5V
Purple	E6	Ic(ON)	500	696	μA	I _F =4mA, V _{CE} =3.5V
White	E7	Ic(ON)	571	784	μA	I _F =4mA, V _{CE} =3.5V
Brown	E8	Ic(ON)	643	872	μA	I _F =4mA, V _{CE} =3.5V
Orange	E9	Ic(ON)	714	960	μA	I _F =4mA, V _{CE} =3.5V

Typical Electro-Optical Characteristics Curves

Fig.1 Forward Current vs. Ambient Temperature

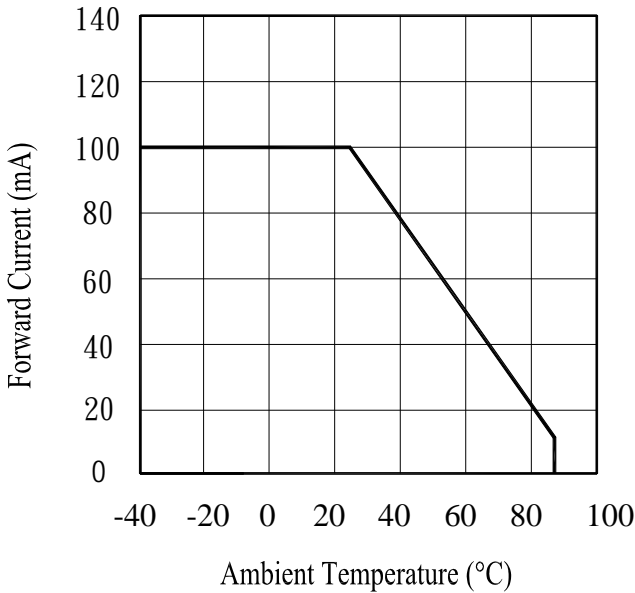

Fig.2 Spectral Distribution

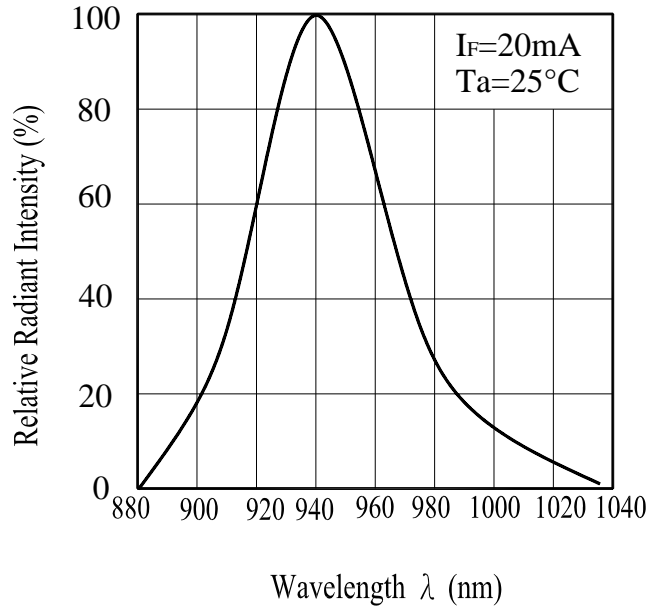

Fig.3 Peak Emission Wavelength vs. Ambient Temperature

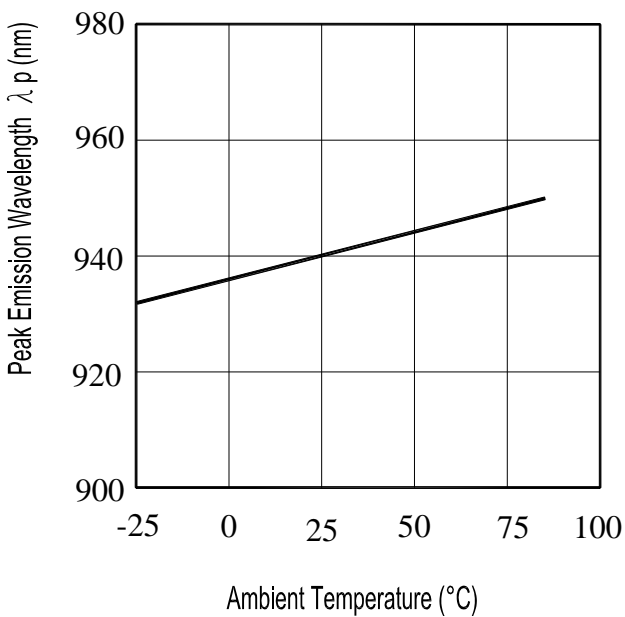
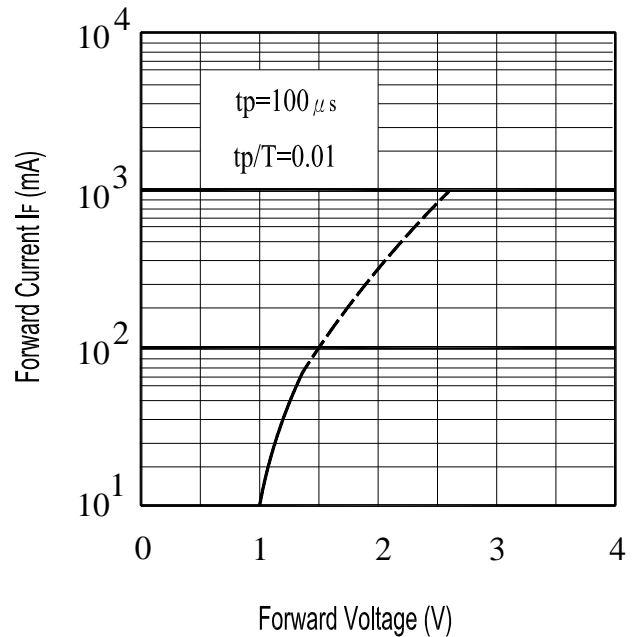

Fig.4 Forward Current vs. Forward Voltage



Typical Electro-Optical Characteristics Curves

Fig.5 Forward Voltage vs. Ambient Temperature

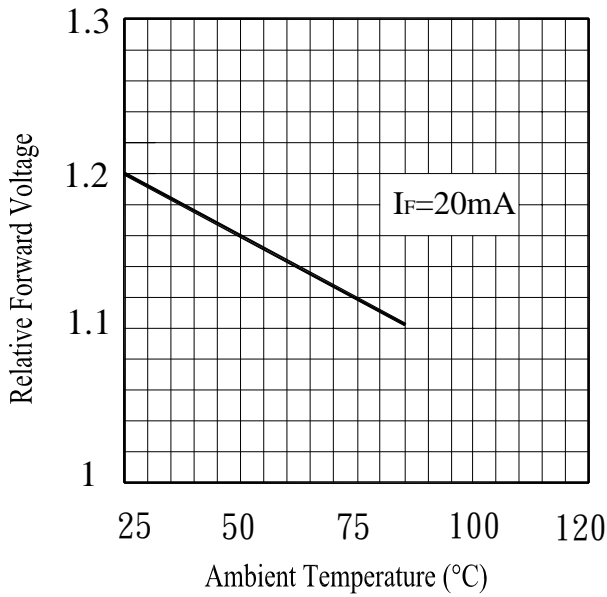
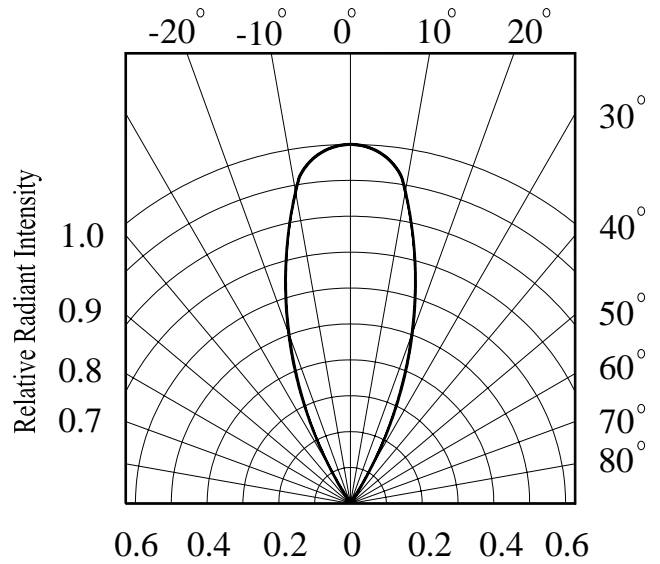

Fig.6 Relative Radiant Intensity vs. Angular Displacement



■ **Test Method For $I_{C(ON)}$:**

Condition: $I_F=4mA, V_{CE}=3.5V$

The intensity testing method for infrared emitting diode

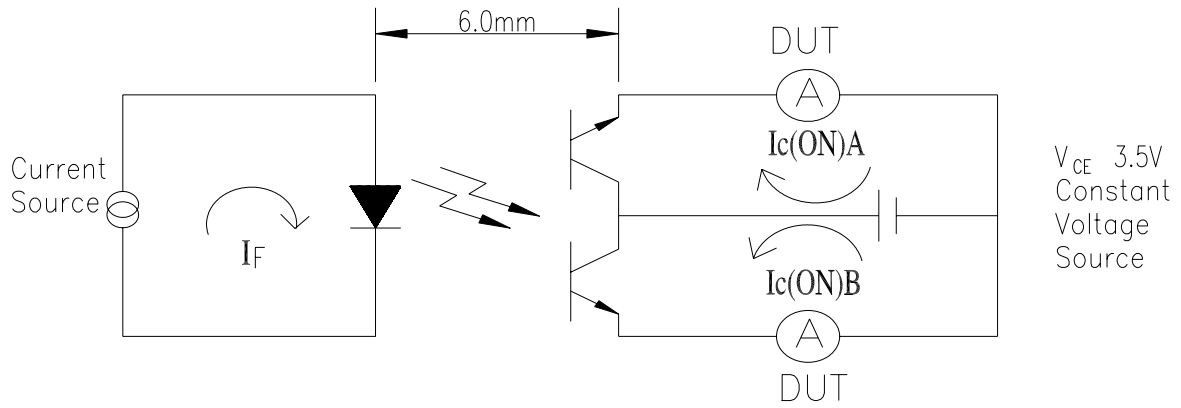

Looking for pricing, stock, or lifecycle information?

Click below to explore more details on WIN SOURCE:

- [View IR928-6C-F on WIN SOURCE](#)
- [Everlight Electronics Co Ltd Information](#)

Optimize Your Supply Chain with WIN SOURCE Solutions

- ✓ Global Sourcing Solution
- ✓ Obsolete Management
- ✓ Cost Control Management
- ✓ Shortage Management
- ✓ Alternative Solution
- ✓ Excess Inventory Management