

本公司智慧財產，未經同意不得複製
Diptronics copyright,
may not be used without permission from Diptronics.

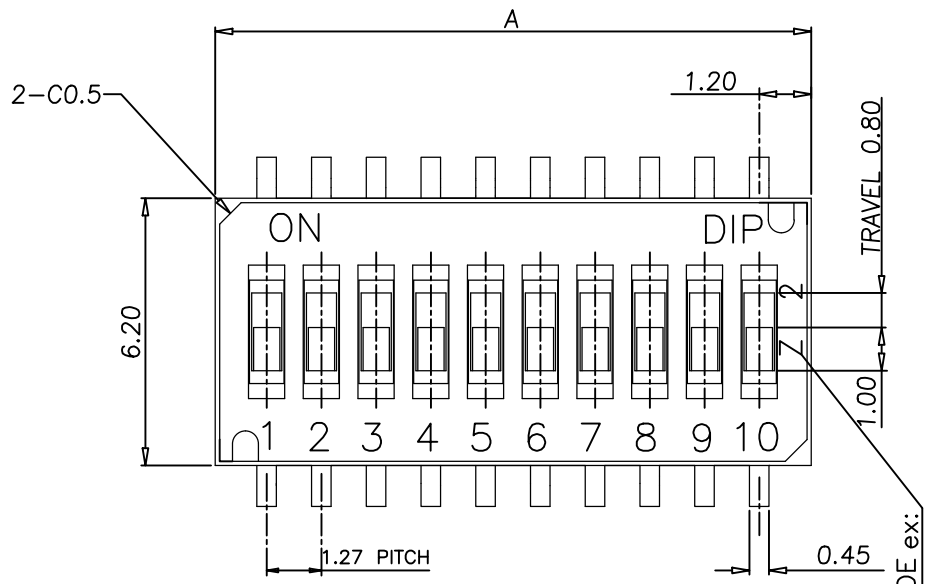

DATE CODE ex: (M) (Y) (0,1,2,~9)
(1,2~9,X,Y,Z)

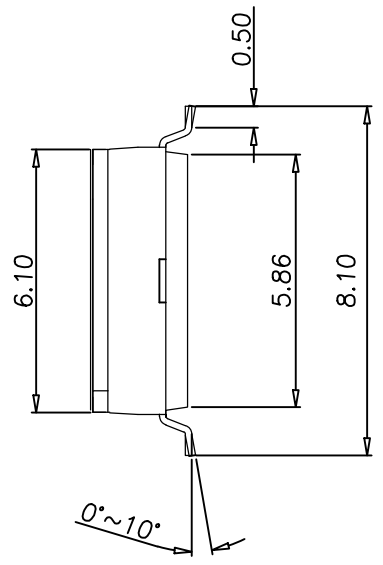

DHA-12TQ	12	16.37
DHA-10TQ	10	13.83
DHA-08TQ	8	11.29
DHA-06TQ	6	8.75
DHA-04TQ	4	6.21
PROD.NO.	NO. OF POS	DIM A
SCHEMATIC(TYP.)		
(4,6,8,10,12 POS AVAIL)		

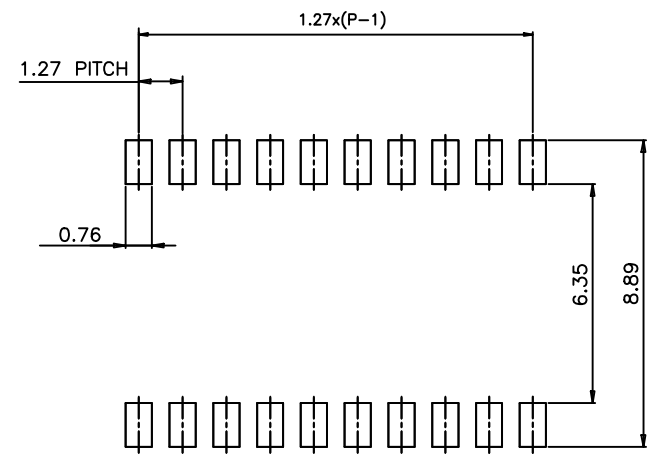
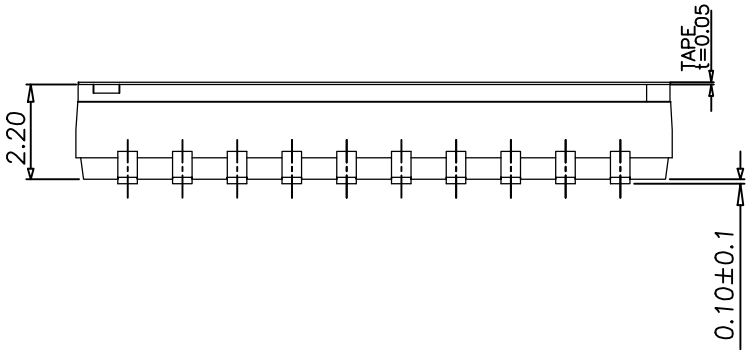

P.C.B. LAYOUT

NOTE:
1. ALL DIMENSIONS ARE IN MILLIMETERS.
2. GENERAL TOLERANCES: ±0.20mm.

ZONE	REV	DESCRIPTION	DATE	APPD.
	C	依<技規20057>執行變更	2025.05.15	
	B	依<工製16029>執行變更	2017.02.17	邱明義
	A	DWG.REL	4.10'12	邱明義

APPD:	DATE:	圓達實業股份有限公司 DIPTRONICS MANUFACTURING INC.	PART NAME:
CHKD: 歐峰怡	SCALE: 2:1		S.M.T TYPE (HALF PITCH)
DR: 朱育釐	REV: C	UNITS: mm	DWG NO:
DESIGN: Wilson		PART NO: DHA-□□ TQ	FINISH:
			RD10PA



DHA-□□-Q SPECIFICATION

FILE No. : E-Q-AD18
 REV. : A
 Page : 1 / 4

1. Style:

This specification describes "WASHABLE OF DUAL IN-LINE PACKAGE SWITCHES", mainly used as signal switch of electric devices, with the general requirements of mechanical and electrical characteristics.

- 1.1 Operating Temperature Range : -40°C ~85°C
- 1.2 Storage Temperature Range : -40°C ~85°C
- 1.3 The shelf life of product is within 6 months.

2. Current Range:

- 2.1 Non-Switching: 100mA, 50V DC
- 2.2 Switching: 25mA, 24V DC

3. Type of Actuation: Actuated by sliding

4. Test Sequence:

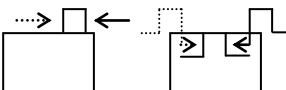
ITEM	DESCRIPTION	TEST CONDITIONS	REQUIREMENTS	
1.	Visual Examination	By visual examination check without any out pressure & testing.	There shall be no defects that affect the serviceability of the product.	
MECHANICAL PERFORMANCE	2.	Contact Resistance	1.To be measured between the two terminals associated with each switch pole. 2.Measurements shall be made with a 1 kHz shall current contact resistance meter.	100mΩ max. (initial)
	3.	Insulation Resistance	500 V DC , 1 minute±5 sec.	100MΩ min
	4.	Dielectric withstanding Voltage	300 V AC (50Hz or 60 Hz) shall be applied between all the adjacent terminals and between the terminal and the frame for 1 minute.	There shall be no breakdown or flashover.
	5	Operation Force	Applied in the direction of operation. ON→OFF OFF→ON 	500 gf max – DHA
	6	Stop Strength	DHA: 0.8 kgf is applied in the operating direction and pulling direction operated for a period of 15 seconds.	There shall be no sign of damage mechanically.



DHA-□□-Q SPECIFICATION

FILE No. : E-Q-AD18
 REV. : A
 Page : 2 / 4

MECHANICAL PERFORMANCE	7	Soldering Heat Resistance	Soldering Temperature :		1)As shown in item 3~6 2)Contact Resistance: 200 max. (final-after test)
			PROD SERIES	SMT TYPE TERMINAL DHA	
			TEMP TIME	See the Temperature profile	
			1.Duration of Solder Immersion: 5±1seconds. 2.Frequency of Solder Process: 1 time max. (PCB is 1.6 mm in thickness.)		
MECHANICAL PERFORMANCE	8	Vibration	Shall be vibrated in accordance with Method 201A of MIL-STD-202F		Ditto
			1)Frequency: 10-55-10 Hz 1 min/cycle.		
			2)Direction: 3 vertical directions including the direction of operation. 3)Test Time: 2 hours each direction.		
MECHANICAL PERFORMANCE	9	Shock	Shall be shocked in accordance with Method 213B Condition A of MIL-STD-202F		Ditto
			1)Acceleration : 50G		
			2)Action Time : 11±1 m seconds 3)Testing Direction : 6 sides 4)Test cycle : 3 times in each direction		
DURABILITY	10	Operation Life	Measurements shall be made following the test set forth below: 1.25mA,24 V DC resistive load 2.Rate of Operation : 15~20 cycles/minute 3.Cycle of Operation : 1000 cycles		1)As shown in item 3~6 2)Contact Resistance: 1Ω max. (final-after test)
WEATHER-PROOF	11	Resistance Low Temperature	Following the test set forth below the sample shall be left in normal temperature and humidity conditions for an hour before measurements are made : 1.Temperature : -40±3℃ 2.Time : 96 hours		1)As shown in item 3~6 2)Contact Resistance: 200mΩ max. (final-after test)
		Resistance High Temperature	Following the test set forth below the sample shall be left in normal temperature and humidity conditions for an hour before measurements are made : 1.Temperature :85±2℃ 2.Time : 96 hours		Ditto



DHA-□□-Q SPECIFICATION

FILE No. : E-Q-AD18
 REV. : A
 Page : 3 / 4

13	Resistance Humidity	<p>Following the test set forth below the sample shall be left in normal temperature and humidity conditions for an hour before measurements are made :</p> <p>① Temperature : $40\pm 2^{\circ}\text{C}$ ② Relative Humidity : 90~95% ③ Time : 96 hours</p>	<p>1)As shown in item 4~6 2)Contact Resistance :200-mΩ max. 3)Insulation Resistance: 10 MΩ min .</p>
----	------------------------	--	--

5. SOLDERING CONDITIONS:

Condition for Soldering- DHA-Q Series

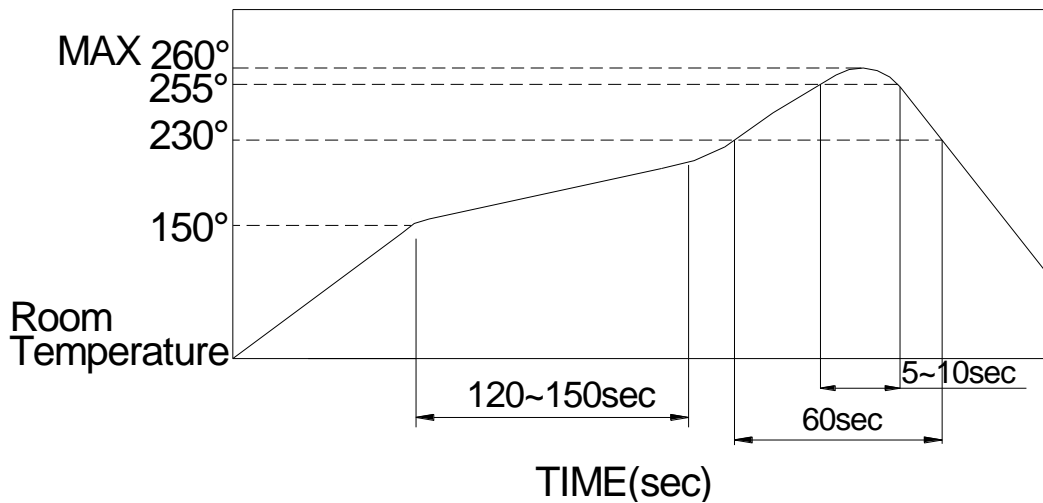

- The condition mentioned above is the temperature on the Cu foil of the PCB surface. There are cases where board's temperature greatly differs from switch's surface temperature depending on board's material, size, thickness, etc. Care, therefore, should be used not to allow switch's surface temperature to exceed 260°C .

■ Manual Soldering

Soldering Temperature	Max, 350°C
Continuous Soldering Time	Max, 5 seconds

■ Precautions in Handling

1. Care should be exercised so that flux from the upper part of the printed circuit board does not adhere to the switch.
2. Don't clean the switch body except with top tape sealed type, which can only spray of cleaning method from top of s/w.

■ Notes on storage conditions:

Do not store in the following environment or it may affect product's function and solderability:



DHA-□□-Q SPECIFICATION

FILE No. : E-Q-AD18
REV. : A
Page : 4 / 4

1. temperature of -10 (max) ~ +40 (min) °C & humidity at 85% (min)
2. environment with corrosive gas
3. storage over 6 months
4. place of direct sunlight

Store with proper packaging conditions and to avoid loading heavy force

We suggest to use the products within 3 months or at least 6 months.

After opening the package, the rest products must be stored in the appropriate moisture-proof & airtight environment.

3 4 5 6 7

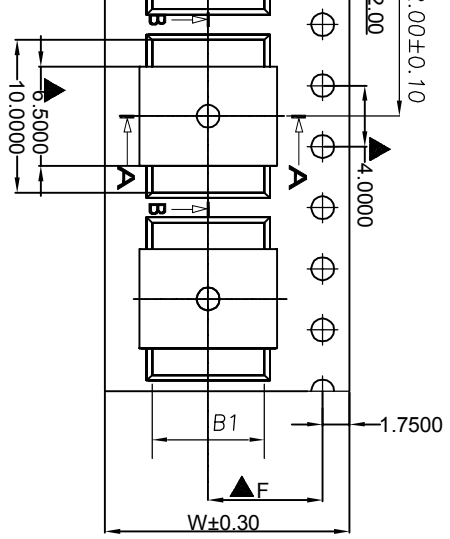

pe running direction

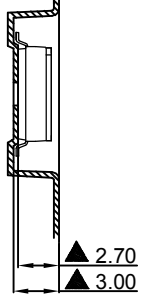

B-B Section

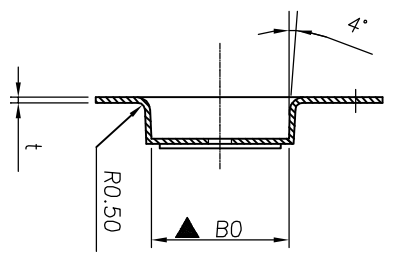

A-A Section

底部厚度 0.10mm以上

- 1. Pitch Tolerance Over Any 10 Pitch±0.20.
- 2. General Tolerance Max±0.1mm.
- 3. 未標角度為4°

20±0.1	16.74	15.19	0.35±0.05
90±0.1	14.20	12.65	0.35±0.05
50±0.1	11.65	10.10	0.35±0.05
0±0.1	4.00	2.45	0.35±0.05
0±0.1	9.10	7.55	0.35±0.05
0±0.1	6.55	5.00	0.35±0.05
M F	DIM B0	DIM B1	DIM t

APPD:	Q'TY:	 圓達實業股份有限公司 DIPTRONICS MANUFACTURING INC.		PART NAME:
CHKD:	SCALE:			3:1
DR:	REV:	D	UNITS:	mm
DESIGN:	黃世軍	見附表	MAT'L:	PS (透明)
			FINISH:	
			DWG NO:	EP-C261

F

E

D



C

B

A

Looking for pricing, stock, or lifecycle information?

Click below to explore more details on WIN SOURCE:

-  [View DHA-04TQR on WIN SOURCE](#)
-  [Diptronics Information](#)

Optimize Your Supply Chain with WIN SOURCE Solutions

-  Global Sourcing Solution
-  Obsolete Management
-  Cost Control Management
-  Shortage Management
-  Alternative Solution
-  Excess Inventory Management