



**THE DATASHEET OF
HBDM60V600W-7**



COMPLEX TRANSISTOR ARRAY FOR BIPOLAR TRANSISTOR HALF H-BRIDGE MOTOR/ACTUATOR DRIVER
Features

- Epitaxial Planar Die Construction
- **Totally Lead-Free & Fully RoHS Compliant (Notes 1 & 2)**
- **Halogen and Antimony Free. "Green" Device (Note 3)**

Sub-Component P/N	Reference	Device Type
MMBT2907A_DIE	Q1	PNP Transistor
MMBTA06_DIE	Q2	NPN Transistor

 Existing Product
Top View

Mechanical Data

- Case: SOT-363
- Case Material: Molded Plastic, "Green" Molding Compound. UL Flammability Classification Rating 94V-0
- Moisture Sensitivity: Level 1 per J-STD-020D
- Terminal Connections: See Schematic & Pin Configuration
- Terminals: Finish—Matte Tin Annealed over Alloy 42 Leadframe. Solderable per MIL-STD-202, Method 208 (3)
- Marking Information: See Page 6
- Ordering Information: See Page 6
- Weight: 0.016 grams (Approximate)

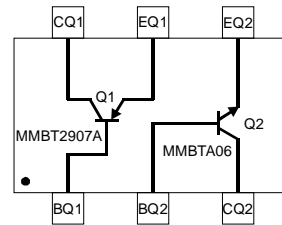

Device Schematic

Ordering Information (Note 4)

Part Number	Compliance	Case	Packaging
HBDM60V600W-7	Standard	SOT-363	3000/Tape & Reel

- Notes:
1. No purposely added lead. Fully EU Directive 2002/95/EC (RoHS), 2011/65/EU (RoHS 2) & 2015/863/EU (RoHS 3) compliant.
 2. See <https://www.diodes.com/quality/lead-free/> for more information about Diodes Incorporated's definitions of Halogen- and Antimony-free, "Green" and Lead-free.
 3. Halogen- and Antimony-free "Green" products are defined as those which contain <900ppm bromine, <900ppm chlorine (<1500ppm total Br + Cl) and <1000ppm antimony compounds.
 4. For packaging details, go to our website at <http://www.diodes.com/datasheets/ap02007.pdf>.

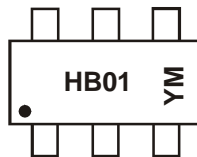
Marking Information

HB01 = Product Type Marking Code
 YM = Date Code Marking
 Y = Year (ex: G = 2019)
 M = Month (ex: 9 = September)

Date Code Key

Year	2006	2007	...	2019	2020	2021	2022	2023	2024	2025
Code	T	U	...	G	H	I	J	K	L	M

Month	Jan	Feb	Mar	Apr	May	Jun	Jul	Aug	Sep	Oct	Nov	Dec
Code	1	2	3	4	5	6	7	8	9	O	N	D

Maximum Ratings: Total Device @ $T_A = 25^\circ\text{C}$ (unless otherwise specified)

Characteristic	Symbol	Value	Unit
Operating and Storage Temperature Range	T_{OP}, T_{stg}	-55 to +150	$^\circ\text{C}$

Thermal Characteristics: Total Device

Characteristic	Symbol	Value	Unit
Power Dissipation (Note 5)	P_D	200	mW
Thermal Resistance, Junction to Ambient Air (Note 5)	$R_{\theta JA}$	625	$^\circ\text{C/W}$

Maximum Ratings: Sub-Component Devices @ $T_A = 25^\circ\text{C}$ unless otherwise specified

Characteristic	Symbol	Q1-PNP Transistor (MMBT2907A)	Q2-NPN Transistor (MMBTA06)	Unit
Collector-Base Voltage	V_{CBO}	-60	80	V
Collector-Emitter Voltage	V_{CEO}	-60	65	V
Emitter-Base Voltage	V_{EBO}	-5.5	6	V
Collector Current - Continuous (Note 5)	I_C	-600	500	mA

Note: 5. Device mounted on FR-4 substrate printed circuit board with 1 inch square 2oz copper pad area

Electrical Characteristics: PNP (MMBT2907A) Transistor (Q1) @ $T_A = 25^\circ\text{C}$ unless otherwise specified

Characteristic	Symbol	Min	Max	Unit	Test Condition
OFF CHARACTERISTICS (Note 6)					
Collector-Base Breakdown Voltage	$V_{(BR)CBO}$	-60	—	V	$I_C = -10\mu\text{A}, I_E = 0$
Collector-Emitter Breakdown Voltage	$V_{(BR)CEO}$	-60	—	V	$I_C = -10\text{mA}, I_B = 0$
Emitter-Base Breakdown Voltage	$V_{(BR)EBO}$	-5.5	—	V	$I_E = -10\mu\text{A}, I_C = 0$
Collector Cutoff Current	I_{CBO}	—	-10	nA	$V_{CB} = -50\text{V}, I_E = 0$
Collector Cutoff Current	I_{CEX}	—	-50	nA	$V_{CE} = -30\text{V}, V_{EB(OFF)} = -0.5\text{V}$
Base Cutoff Current	I_{BL}	—	-50	nA	$V_{CE} = -30\text{V}, V_{EB(OFF)} = -0.5\text{V}$
ON CHARACTERISTICS (Note 6)					
DC Current Gain	h_{FE}	100	—	—	$I_C = -100\mu\text{A}, V_{CE} = -10\text{V}$
		100	—	—	$I_C = -1.0\text{mA}, V_{CE} = -10\text{V}$
		100	—	—	$I_C = -10\text{mA}, V_{CE} = -10\text{V}$
		100	300	—	$I_C = -150\text{mA}, V_{CE} = -10\text{V}$
		50	—	—	$I_C = -500\text{mA}, V_{CE} = -10\text{V}$
Collector-Emitter Saturation Voltage	$V_{CE(SAT)}$	—	-0.3 -0.5	V	$I_C = -150\text{mA}, I_B = -15\text{mA}$ $I_C = -500\text{mA}, I_B = -50\text{mA}$
Base-Emitter Saturation Voltage	$V_{BE(SAT)}$	—	-0.95 -1.3	V	$I_C = -150\text{mA}, I_B = -15\text{mA}$ $I_C = -500\text{mA}, I_B = -50\text{mA}$
SMALL SIGNAL CHARACTERISTICS					
Current Gain-Bandwidth Product	f_T	100	—	MHz	$V_{CE} = -2.0\text{V}, I_C = -10\text{mA}, f = 100\text{MHz}$
SWITCHING CHARACTERISTICS					
Turn-On Time	t_{on}	—	45	ns	$V_{CE} = -30\text{V}, I_C = -150\text{mA}, I_{B1} = -15\text{mA}$
Delay Time	t_d	—	10	ns	
Rise Time	t_r	—	40	ns	
Turn-Off Time	t_{off}	—	100	ns	$V_{CC} = -6.0\text{V}, I_C = -150\text{mA}, I_{B1} = I_{B2} = -15\text{mA}$
Storage Time	t_s	—	80	ns	
Fall Time	t_f	—	30	ns	

Electrical Characteristics: NPN (MMBTA06) Transistor (Q2) @ $T_A = 25^\circ\text{C}$ unless otherwise specified

Characteristic	Symbol	Min	Typ	Max	Unit	Test Condition
OFF CHARACTERISTICS (Note 6)						
Collector-Base Breakdown Voltage	$V_{(BR)CBO}$	80	—	—	V	$I_C = 100\mu\text{A}, I_E = 0$
Collector-Emitter Breakdown Voltage	$V_{(BR)CEO}$	65	—	—	V	$I_C = 1\text{mA}, I_B = 0$
Emitter-Base Breakdown Voltage	$V_{(BR)EBO}$	6	—	—	V	$I_E = 100\mu\text{A}, I_C = 0$
Collector-Base Cutoff Current	I_{CBO}	—	—	100	nA	$V_{CB} = 80\text{V}, I_E = 0$
Collector Cutoff Current	I_{CES}	—	—	100	nA	$V_{CE} = 90\text{V}, V_{BE} = 0$
Emitter-Base Cutoff Current	I_{EBO}	—	—	100	nA	$V_{EB} = 5\text{V}, I_C = 0$
ON CHARACTERISTICS (Note 6)						
DC Current Gain	h_{FE}	250	—	—	—	$V_{CE} = 1\text{V}, I_C = 10\text{mA}$
		100	—	—	—	$V_{CE} = 1\text{V}, I_C = 100\text{mA}$
Collector-Emitter Saturation Voltage	$V_{CE(SAT)}$	—	0.2	0.4	V	$I_C = 100\text{mA}, I_B = 10\text{mA}$
Base-Emitter Turn-on Voltage	$V_{BE(ON)}$	0.7	0.75	0.8	V	$V_{CE} = 1\text{V}, I_C = 100\text{mA}$
Base-Emitter Saturation Voltage	$V_{BE(SAT)}$	—	—	0.95	V	$I_C = 100\text{mA}, I_B = 5\text{mA}$
SMALL SIGNAL CHARACTERISTICS						
Current Gain-Bandwidth Product	f_T	100	—	—	MHz	$V_{CE} = 20\text{V}, I_C = 10\text{mA}, f = 100\text{MHz}$

Notes: 6. Short duration pulse test used to minimize self-heating effect.

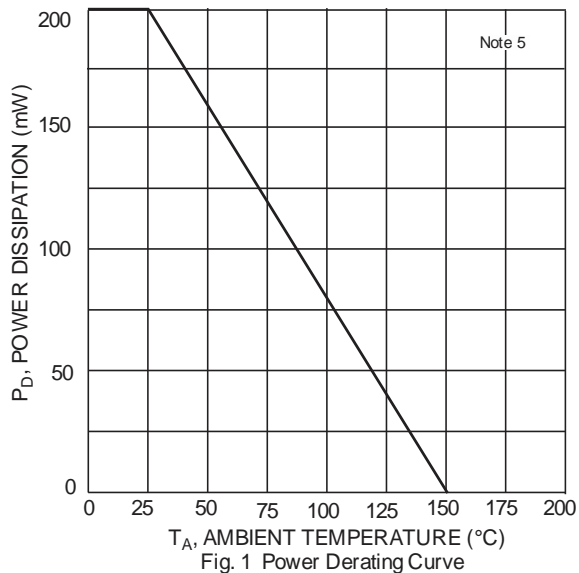
Typical Characteristics @ $T_A = 25^\circ\text{C}$ unless otherwise specified

PNP (MMBT2907A) Transistor (Q1) Plots

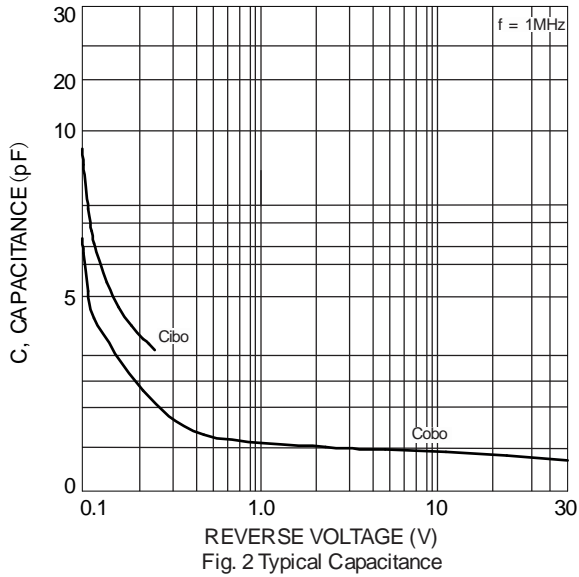

Fig. 2 Typical Capacitance

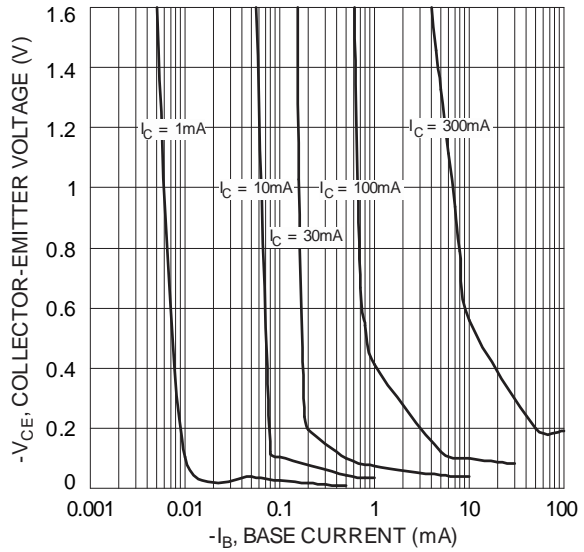

Fig. 3 Typical Collector Saturation Region

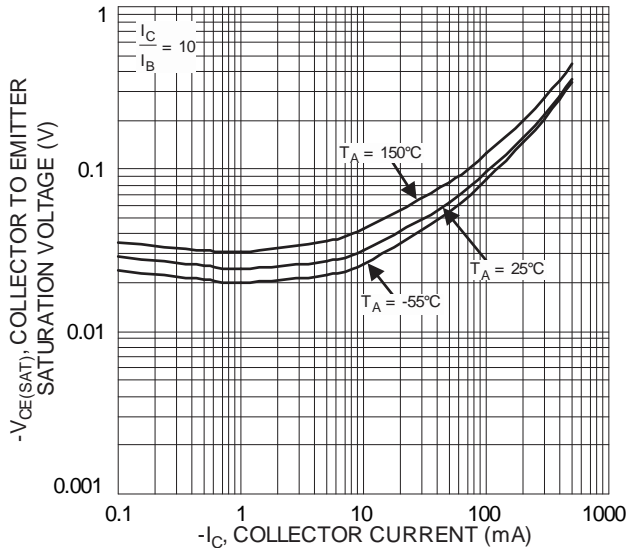

Fig. 4 Collector Emitter Saturation Voltage vs. Collector Current

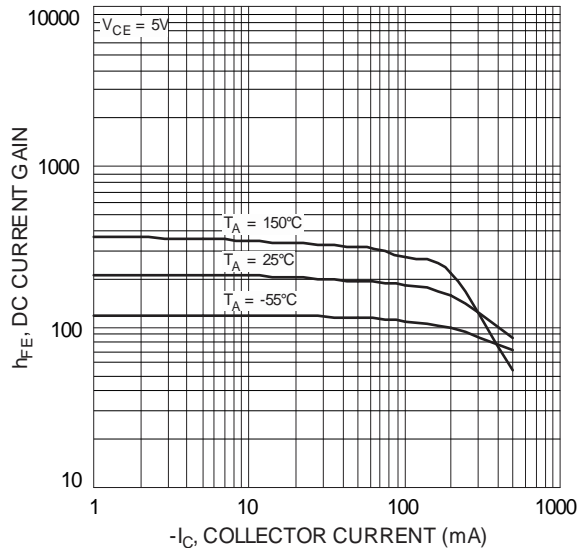

Fig. 5 Typical DC Current Gain vs. Collector Current

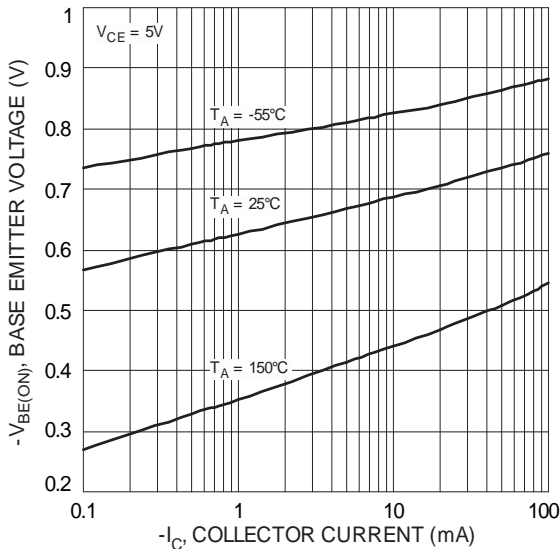

Fig. 6 Typical Base Emitter Voltage vs. Collector Current

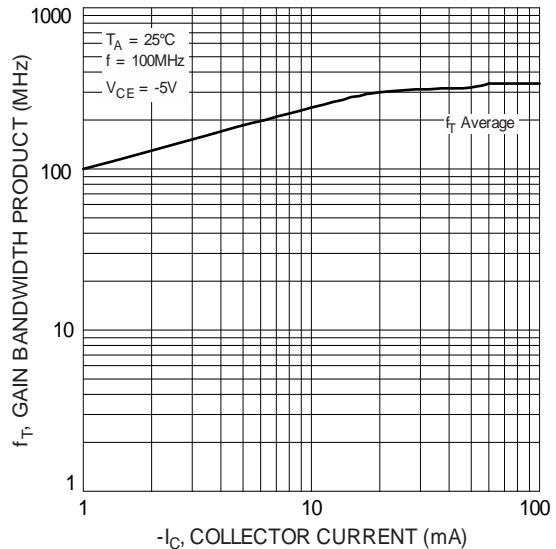

Fig. 7 Typical Gain Bandwidth Product vs. Collector Current

NPN (MMBTA06) Transistor (Q2) Plots

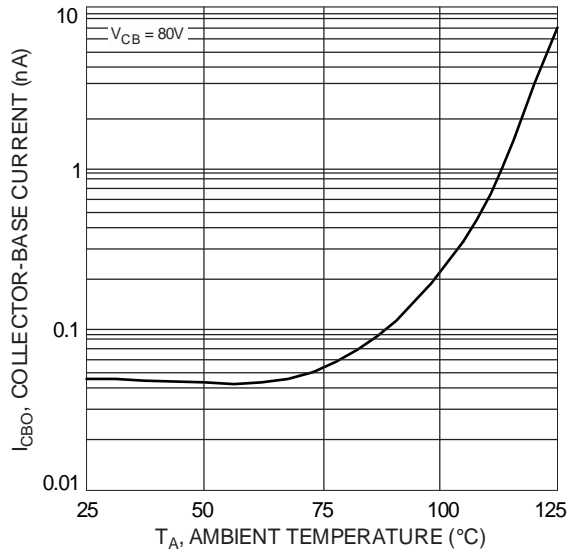

Fig. 8 Typical Collector-Cutoff Current vs. Ambient Temperature

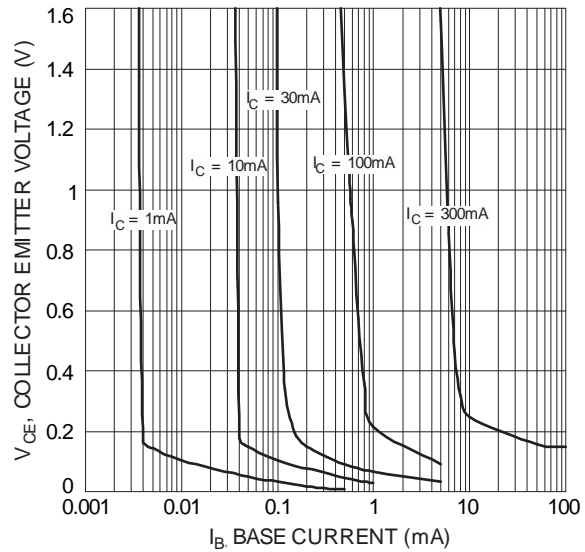

Fig. 9 Typical Collector Saturation Region

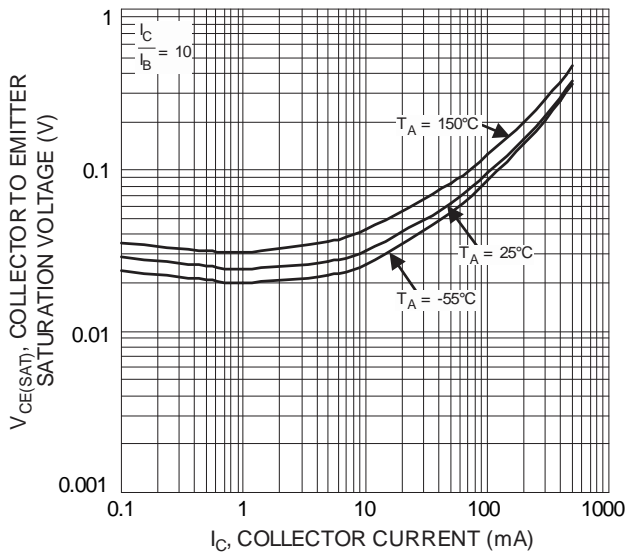

Fig. 10 Typical Collector Emitter Saturation Voltage vs. Collector Current

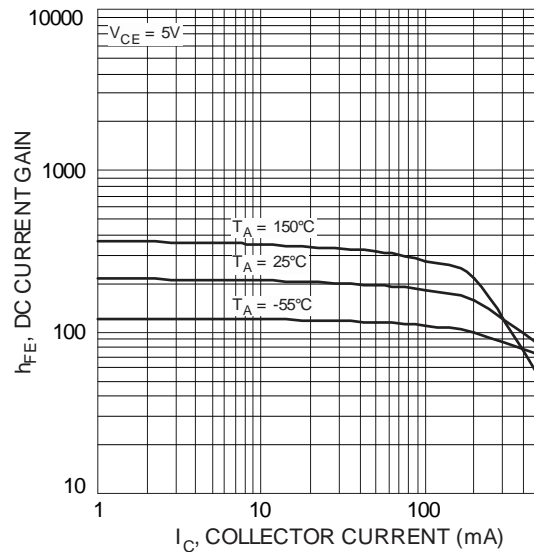

Fig. 11 Typical DC Current Gain vs. Collector Current

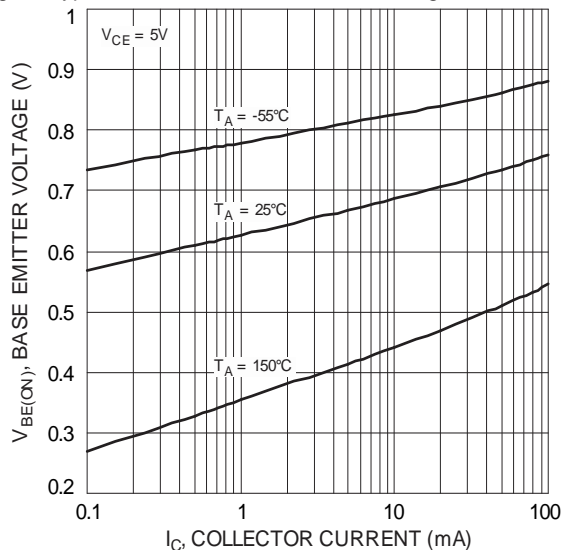

Fig. 12 Typical Base Emitter Voltage vs. Collector Current

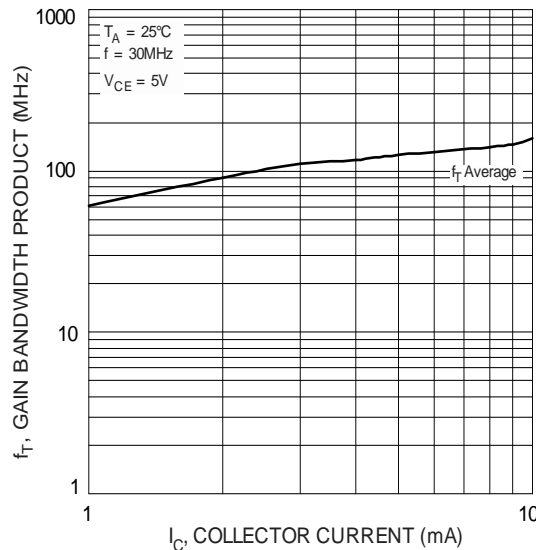
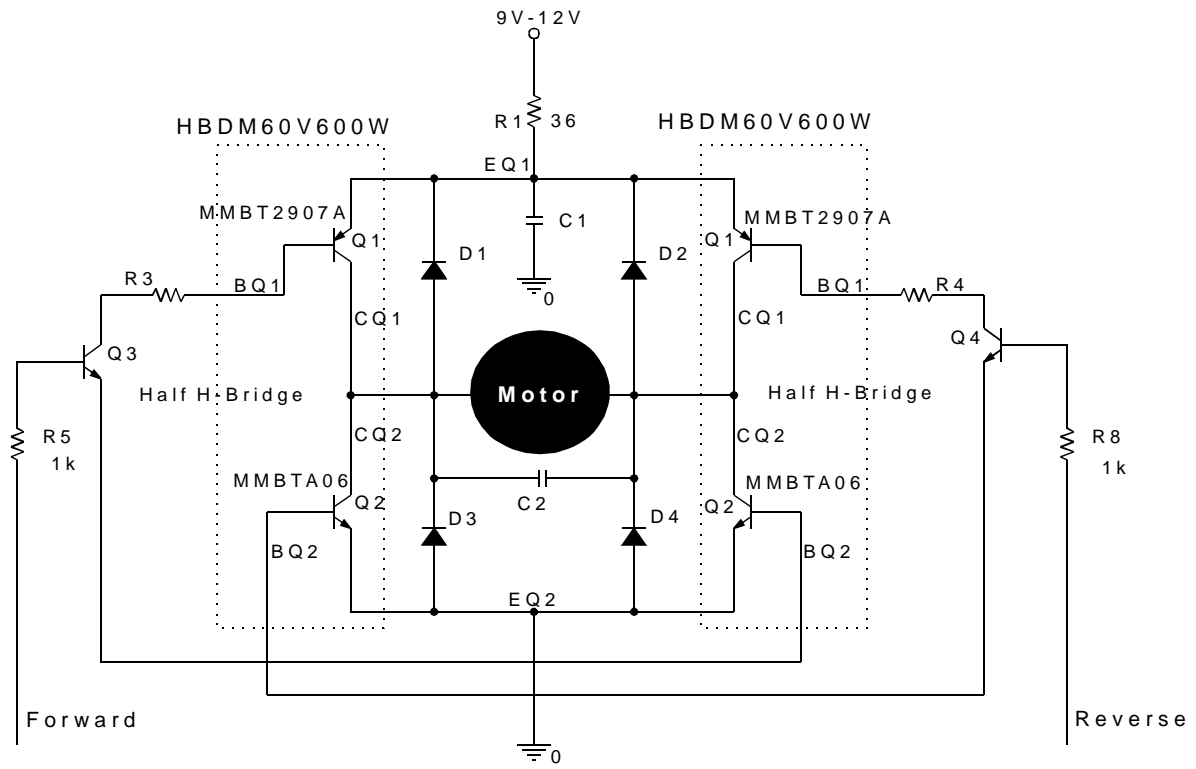

Fig. 13 Typical Gain Bandwidth Product vs. Collector Current

Current Schematic with Application Example



Note: D1, D2, D3, D4: Switching Diodes (MMBD4448)
Q3, Q4: NPN Transistors (MMBTA06)

Application Example Schematic (with Package Pinouts)

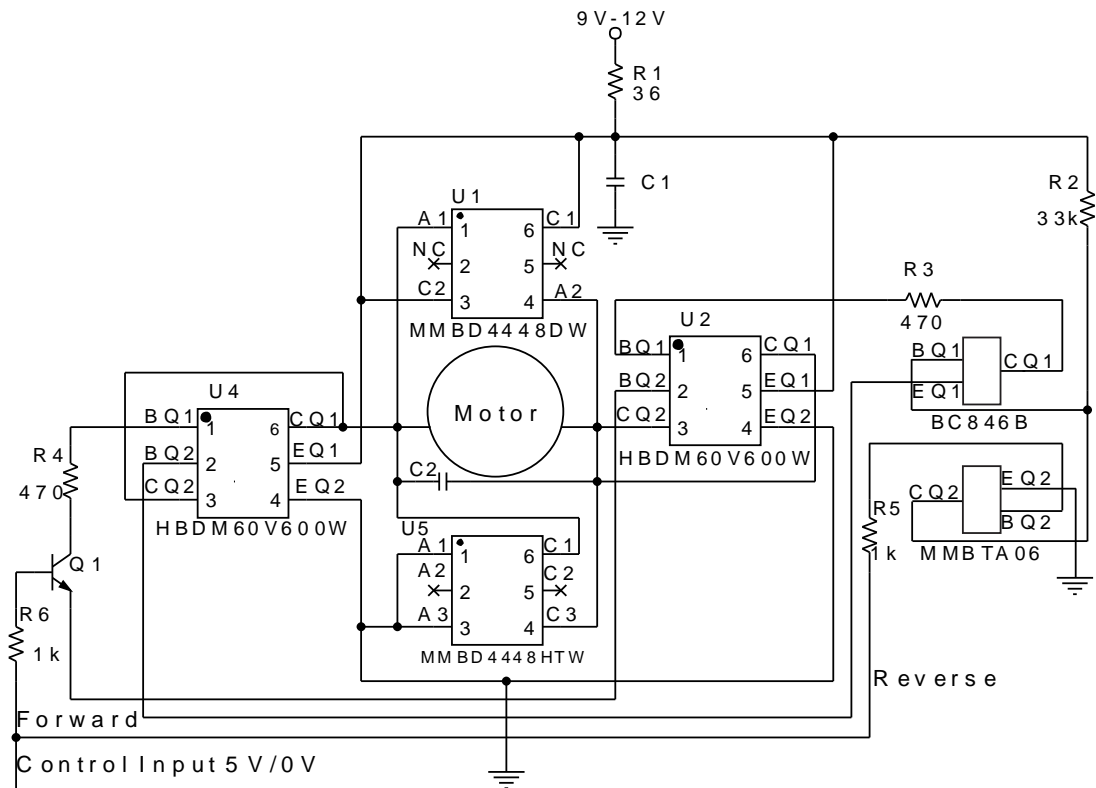

Package Outline Dimensions

Please see <http://www.diodes.com/package-outlines.html> for the latest version.

SOT363

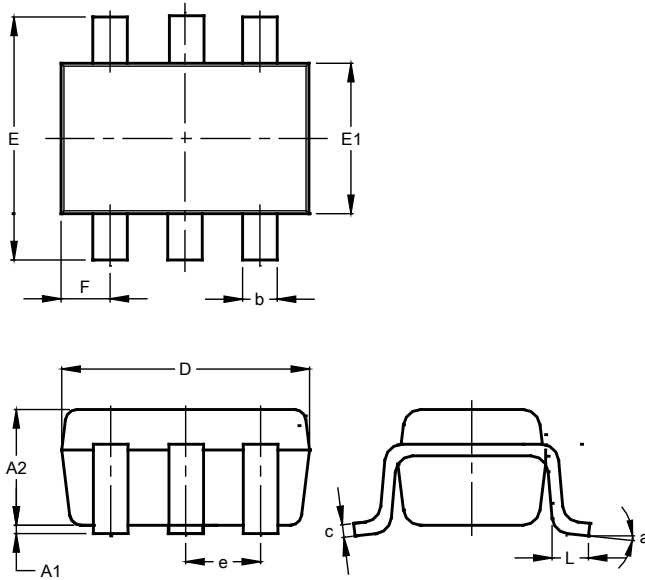

SOT363			
Dim	Min	Max	Typ
A1	0.00	0.10	0.05
A2	0.90	1.00	0.95
b	0.10	0.30	0.25
c	0.10	0.22	0.11
D	1.80	2.20	2.15
E	2.00	2.20	2.10
E1	1.15	1.35	1.30
e	0.650 BSC		
F	0.40	0.45	0.425
L	0.25	0.40	0.30
a	0°	8°	--
All Dimensions in mm			

Suggested Pad Layout

Please see <http://www.diodes.com/package-outlines.html> for the latest version.

SOT363

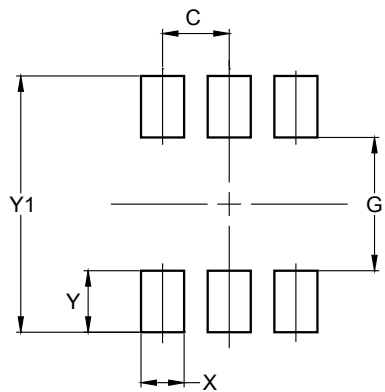

Dimensions	Value (in mm)
C	0.650
G	1.300
X	0.420
Y	0.600
Y1	2.500

IMPORTANT NOTICE

DIODES INCORPORATED MAKES NO WARRANTY OF ANY KIND, EXPRESS OR IMPLIED, WITH REGARDS TO THIS DOCUMENT, INCLUDING, BUT NOT LIMITED TO, THE IMPLIED WARRANTIES OF MERCHANTABILITY AND FITNESS FOR A PARTICULAR PURPOSE (AND THEIR EQUIVALENTS UNDER THE LAWS OF ANY JURISDICTION).

Diodes Incorporated and its subsidiaries reserve the right to make modifications, enhancements, improvements, corrections or other changes without further notice to this document and any product described herein. Diodes Incorporated does not assume any liability arising out of the application or use of this document or any product described herein; neither does Diodes Incorporated convey any license under its patent or trademark rights, nor the rights of others. Any Customer or user of this document or products described herein in such applications shall assume all risks of such use and will agree to hold Diodes Incorporated and all the companies whose products are represented on Diodes Incorporated website, harmless against all damages.

Diodes Incorporated does not warrant or accept any liability whatsoever in respect of any products purchased through unauthorized sales channel. Should Customers purchase or use Diodes Incorporated products for any unintended or unauthorized application, Customers shall indemnify and hold Diodes Incorporated and its representatives harmless against all claims, damages, expenses, and attorney fees arising out of, directly or indirectly, any claim of personal injury or death associated with such unintended or unauthorized application.

Products described herein may be covered by one or more United States, international or foreign patents pending. Product names and markings noted herein may also be covered by one or more United States, international or foreign trademarks.

This document is written in English but may be translated into multiple languages for reference. Only the English version of this document is the final and determinative format released by Diodes Incorporated.

LIFE SUPPORT

Diodes Incorporated products are specifically not authorized for use as critical components in life support devices or systems without the express written approval of the Chief Executive Officer of Diodes Incorporated. As used herein:

A. Life support devices or systems are devices or systems which:

1. are intended to implant into the body, or
2. support or sustain life and whose failure to perform when properly used in accordance with instructions for use provided in the labeling can be reasonably expected to result in significant injury to the user.

B. A critical component is any component in a life support device or system whose failure to perform can be reasonably expected to cause the failure of the life support device or to affect its safety or effectiveness.



Customers represent that they have all necessary expertise in the safety and regulatory ramifications of their life support devices or systems, and acknowledge and agree that they are solely responsible for all legal, regulatory and safety-related requirements concerning their products and any use of Diodes Incorporated products in such safety-critical, life support devices or systems, notwithstanding any devices- or systems-related information or support that may be provided by Diodes Incorporated. Further, Customers must fully indemnify Diodes Incorporated and its representatives against any damages arising out of the use of Diodes Incorporated products in such safety-critical, life support devices or systems.

Copyright © 2019, Diodes Incorporated

www.diodes.com

Looking for pricing, stock, or lifecycle information?

Click below to explore more details on WIN SOURCE:

-  [View HBDM60V600W-7 on WIN SOURCE](#)
-  [Diodes Incorporated Information](#)

Optimize Your Supply Chain with WIN SOURCE Solutions

-  Global Sourcing Solution
-  Obsolete Management
-  Cost Control Management
-  Shortage Management
-  Alternative Solution
-  Excess Inventory Management