



Is Now Part of



**ON Semiconductor®**

To learn more about ON Semiconductor, please visit our website at  
[www.onsemi.com](http://www.onsemi.com)

Please note: As part of the Fairchild Semiconductor integration, some of the Fairchild orderable part numbers will need to change in order to meet ON Semiconductor's system requirements. Since the ON Semiconductor product management systems do not have the ability to manage part nomenclature that utilizes an underscore (\_), the underscore (\_) in the Fairchild part numbers will be changed to a dash (-). This document may contain device numbers with an underscore (\_). Please check the ON Semiconductor website to verify the updated device numbers. The most current and up-to-date ordering information can be found at [www.onsemi.com](http://www.onsemi.com). Please email any questions regarding the system integration to [Fairchild\\_questions@onsemi.com](mailto:Fairchild_questions@onsemi.com).

ON Semiconductor and the ON Semiconductor logo are trademarks of Semiconductor Components Industries, LLC dba ON Semiconductor or its subsidiaries in the United States and/or other countries. ON Semiconductor owns the rights to a number of patents, trademarks, copyrights, trade secrets, and other intellectual property. A listing of ON Semiconductor's product/patent coverage may be accessed at [www.onsemi.com/site/pdf/Patent-Marking.pdf](http://www.onsemi.com/site/pdf/Patent-Marking.pdf). ON Semiconductor reserves the right to make changes without further notice to any products herein. ON Semiconductor makes no warranty, representation or guarantee regarding the suitability of its products for any particular purpose, nor does ON Semiconductor assume any liability arising out of the application or use of any product or circuit, and specifically disclaims any and all liability, including without limitation special, consequential or incidental damages. Buyer is responsible for its products and applications using ON Semiconductor products, including compliance with all laws, regulations and safety requirements or standards, regardless of any support or applications information provided by ON Semiconductor. "Typical" parameters which may be provided in ON Semiconductor data sheets and/or specifications can and do vary in different applications and actual performance may vary over time. All operating parameters, including "Typicals" must be validated for each customer application by customer's technical experts. ON Semiconductor does not convey any license under its patent rights nor the rights of others. ON Semiconductor products are not designed, intended, or authorized for use as a critical component in life support systems or any FDA Class 3 medical devices or medical devices with a same or similar classification in a foreign jurisdiction or any devices intended for implantation in the human body. Should Buyer purchase or use ON Semiconductor products for any such unintended or unauthorized application, Buyer shall indemnify and hold ON Semiconductor and its officers, employees, subsidiaries, affiliates, and distributors harmless against all claims, costs, damages, and expenses, and reasonable attorney fees arising out of, directly or indirectly, any claim of personal injury or death associated with such unintended or unauthorized use, even if such claim alleges that ON Semiconductor was negligent regarding the design or manufacture of the part. ON Semiconductor is an Equal Opportunity/Affirmative Action Employer. This literature is subject to all applicable copyright laws and is not for resale in any manner.

# FPF2163/4/5

## Full Function Load Switch with Adjustable Current Limit

### Features

- 1.8 to 5.5V Input Voltage Range
- Controlled Turn-On
- 0.15-1.5A Adjustable Current Limit
- Undervoltage Lockout
- Thermal Shutdown
- <math>2\mu\text{A}</math> Shutdown Current
- Auto Restart
- Fast Current limit Response Time
  - 5 $\mu\text{s}$  to Moderate Over Currents
  - 30ns to Hard Shorts
- Fault Blanking
- Reverse Current Blocking
- RoHS Compliant

### Applications

- PDAs
- Cell Phones
- GPS Devices
- MP3 Players
- Digital Cameras
- Peripheral Ports
- Hot Swap Supplies



### General Description

The FPF2163, FPF2164, and FPF2165 is a series of load switches which provides full protection to systems and loads which may encounter large current conditions. These devices contain a 0.12 $\Omega$  current-limited P-channel MOSFET which can operate over an input voltage range of 1.8-5.5V. Internally, current is prevented from flowing when the MOSFET is off and the output voltage is higher than the input voltage. Switch control is by a logic input (ON) capable of interfacing directly with low voltage control signals. Each part contains thermal shutdown protection which shuts off the switch to prevent damage to the part when a continuous over-current condition causes excessive heating.

When the switch current reaches the current limit, the parts operate in a constant-current mode to prohibit excessive currents from causing damage. For the FPF2163 and FPF2164, if the constant current condition still persists after 30ms, these parts will shut off the switch and pull the fault signal pin (FLAGB) low. The FPF2163 has an auto-restart feature which will turn the switch on again after 450ms if the ON pin is still active. The FPF2164 does not have this auto-restart feature so the switch will remain off until the ON pin is cycled. The FPF2165 will not turn off after a current limit fault, but will rather remain in the constant current mode indefinitely. The minimum current limit is 150mA.

These parts are available in a space-saving 6 pin 2X2 MLP package.

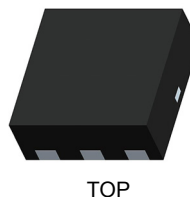
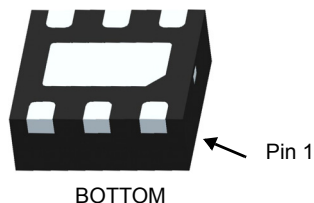

### Ordering Information

Part	Current Limit [mA]	Current Limit Blanking Time [ms]	Auto-Restart Time [ms]	ON Pin Activity	Top Mark
FPF2163	150-1500	15/30/60	225/450/900	Active HI	163
FPF2164	150-1500	15/30/60	NA	Active HI	164
FPF2165	150-1500	0	NA	Active HI	165

### Typical Application Circuit

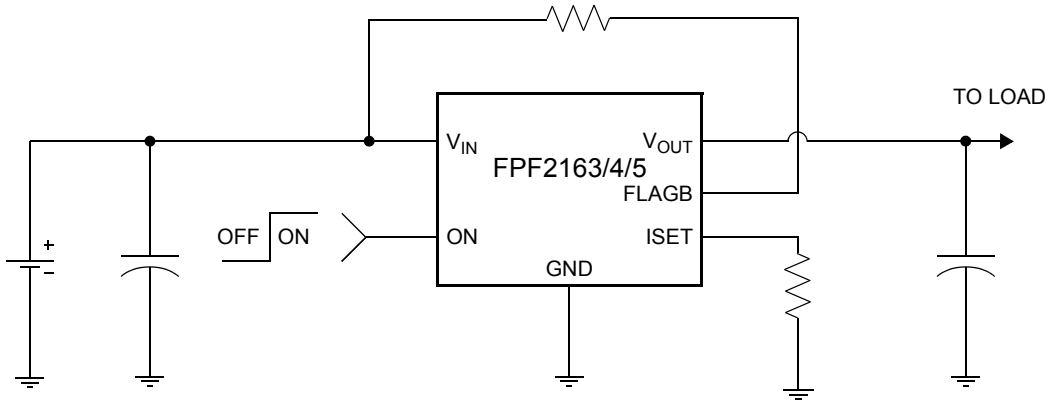

### Functional Block Diagram

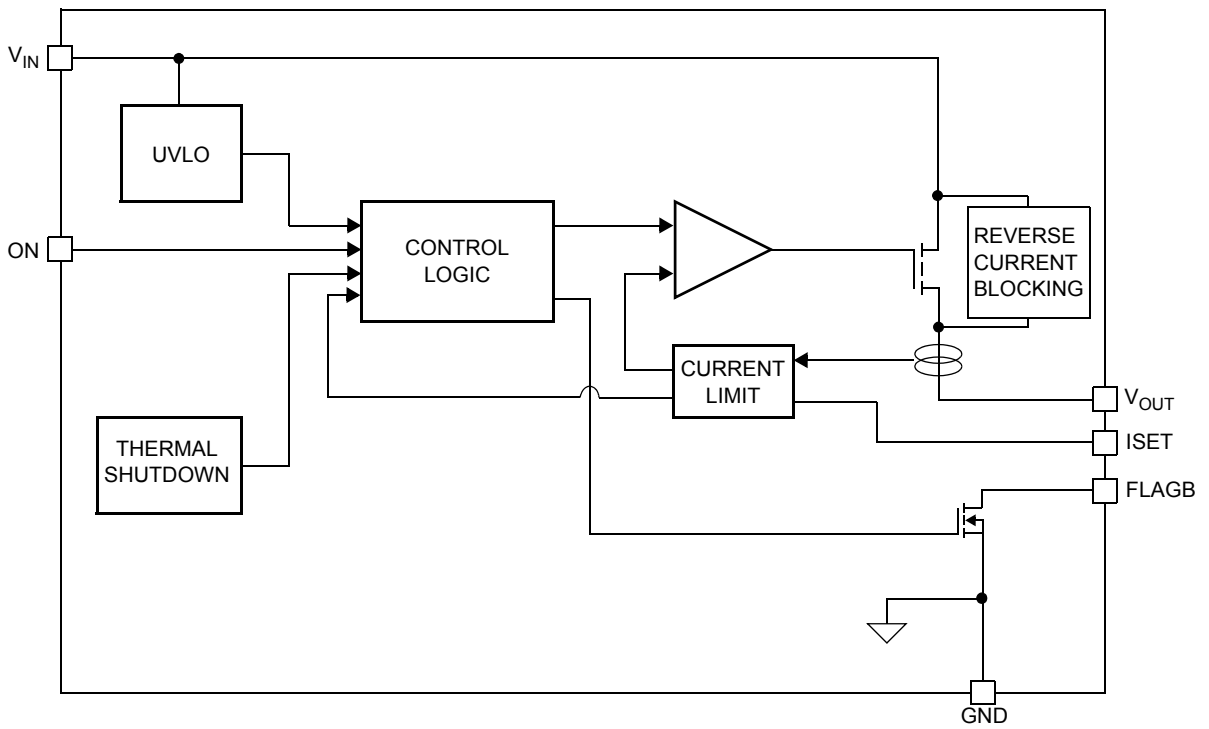

## Pin Configuration

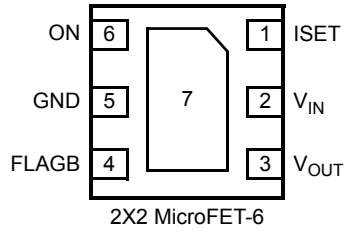

## Pin Description

Pin	Name	Function
1	ISET	Current Limit Set Input: A resistor from ISET to ground sets the current limit for the switch.
2	V <sub>IN</sub>	Supply Input: Input to the power switch and the supply voltage For the IC
3	V <sub>OUT</sub>	Switch Output: Output of the power switch
4	FLAGB	Fault Output: Active LO, open drain output which indicates an over current supply under voltage or over temperature state.
5, 7	GND	Ground
6	ON	ON Control Input

## Absolute Maximum Ratings

Parameter	Min	Max	Unit	
V <sub>IN</sub> , V <sub>OUT</sub> , ON, FLAGB, ISET to GND	-0.3	6	V	
Power Dissipation		1.2	W	
Operating and Storage Junction Temperature	-65	150	°C	
Thermal Resistance, Junction to Ambient		86	°C/W	
Electrostatic Discharge Protection	Jedec A114A	HBM	4000	V
	Jedec C101C	CDM	2000	V
	Jedec A115	MM	400	V
	IEC 61000-4-2	Air Discharge	15000	V
		Contact Discharge	8000	V

## Recommended Operating Range

Parameter	Min	Max	Unit
V <sub>IN</sub>	1.8	5.5	V
Ambient Operating Temperature, T <sub>A</sub>	-40	85	°C

## Electrical Characteristics

V<sub>IN</sub> = 1.8 to 5.5V, T<sub>A</sub> = -40 to +85°C unless otherwise noted. Typical values are at V<sub>IN</sub> = 3.3V and T<sub>A</sub> = 25°C.

Parameter	Symbol	Conditions	Min	Typ	Max	Units	
<b>Basic Operation</b>							
Operating Voltage	V <sub>IN</sub>		1.8		5.5	V	
Quiescent Current	I <sub>Q</sub>	I <sub>OUT</sub> = 0mA	V <sub>IN</sub> = 1.8V		63	100	μA
			V <sub>IN</sub> = 3.3V		68		
			V <sub>IN</sub> = 5.5V		77	120	

**Electrical Characteristics Cont.**
 $V_{IN} = 1.8$  to  $5.5V$ ,  $T_A = -40$  to  $+85^\circ C$  unless otherwise noted. Typical values are at  $V_{IN} = 3.3V$  and  $T_A = 25^\circ C$ .

Parameter	Symbol	Conditions	Min	Typ	Max	Units
On-Resistance	$R_{ON}$	$V_{IN} = 3.3V, I_{OUT} = 200mA, T_A = 25^\circ C$		120	160	m $\Omega$
		$V_{IN} = 3.3V, I_{OUT} = 200mA, T_A = 85^\circ C$		135	180	
		$V_{IN} = 3.3V, I_{OUT} = 200mA, T_A = -40^\circ C$ to $+85^\circ C$	65		180	
ON Input Logic High Voltage (ON)	$V_{IH}$	$V_{IN} = 1.8V$	0.8			V
		$V_{IN} = 5.5V$	1.4			
ON Input Logic Low Voltage	$V_{IL}$	$V_{IN} = 1.8V$			0.5	V
		$V_{IN} = 5.5V$			1	
ON Input Leakage		$V_{ON} = V_{IN}$ or GND	-1		1	$\mu A$
$V_{IN}$ Shutdown Current		$V_{ON} = 0V, V_{IN} = 5.5V,$ $V_{OUT} =$ short to GND	-2		2	$\mu A$
FLAGB Output Logic Low Voltage		$V_{IN} = 5V, I_{SINK} = 10mA$		0.05	0.2	V
		$V_{IN} = 1.8V, I_{SINK} = 10mA$		0.12	0.3	
FLAGB Output High Leakage Current		$V_{IN} = 5V$ , Switch on			1	$\mu A$
<b>Reverse Block</b>						
$V_{OUT}$ Shutdown Current		$V_{ON} = 0V, V_{OUT} = 5.5V,$ $V_{IN} =$ short to GND	-2		2	$\mu A$
<b>Protections</b>						
Current Limit	$I_{LIM}$	$V_{IN} = 3.3V, V_{OUT} = 3.0V, R_{SET} = 345\Omega$	600	800	1000	mA
Min. Current Limit	$I_{LIM(min.)}$	$V_{IN} = 3.3V, V_{OUT} = 3.0V$		150		mA
Thermal Shutdown		Shutdown Threshold		140		$^\circ C$
		Return from Shutdown		130		
		Hysteresis		10		
Under Voltage Shutdown	UVLO	$V_{IN}$ Increasing	1.55	1.65	1.75	V
Under Voltage Shutdown Hysteresis				50		mV
<b>Dynamic</b>						
Delay On Time	$t_{dON}$	$R_L = 500\Omega, C_L = 0.1\mu F$		25		$\mu s$
Delay Off Time	$t_{dOFF}$	$R_L = 500\Omega, C_L = 0.1\mu F$		45		$\mu s$
$V_{OUT}$ Rise Time	$t_{RISE}$	$R_L = 500\Omega, C_L = 0.1\mu F$		10		$\mu s$
$V_{OUT}$ Fall Time	$t_{FALL}$	$R_L = 500\Omega, C_L = 0.1\mu F$		110		$\mu s$
Over Current Blanking Time	$t_{BLANK}$	FPF2163, FPF2164	15	30	60	ms
Auto-Restart Time	$t_{RSTRT}$	FPF2163	225	450	900	ms
Short Circuit Response Time		$V_{IN} = V_{OUT} = 3.3V$ . Moderate Over-Current Condition.		5		$\mu s$
		$V_{IN} = V_{OUT} = 3.3V$ . Hard Short.		30		ns

**Note 1:** Package power dissipation on 1square inch pad, 2 oz copper board.

### Typical Characteristics

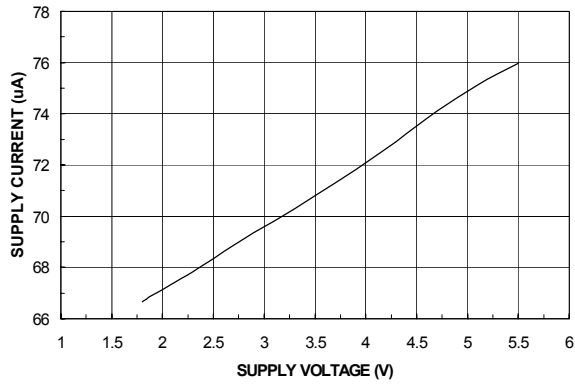

Figure 1. Quiescent Current vs. Input Voltage

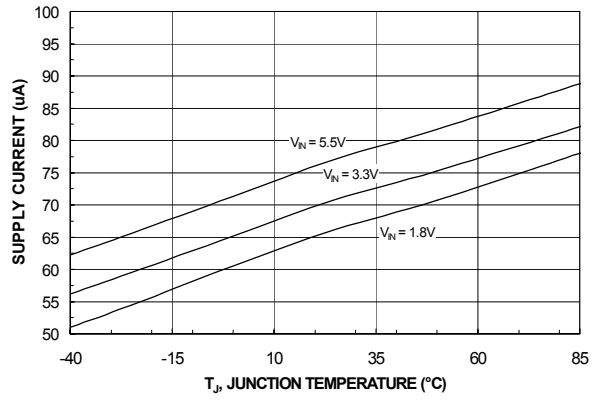

Figure 2. Quiescent Current vs. Temperature

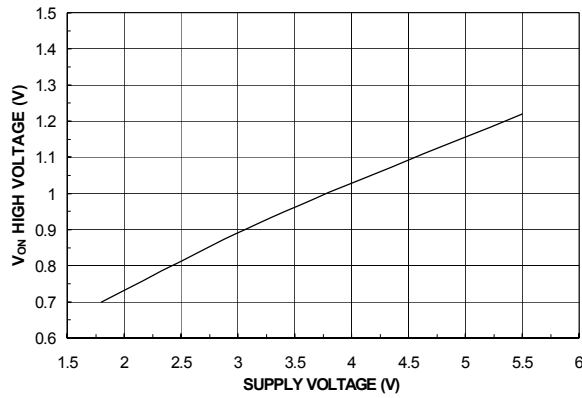

Figure 3.  $V_{ON}$  High Voltage vs. Input Voltage

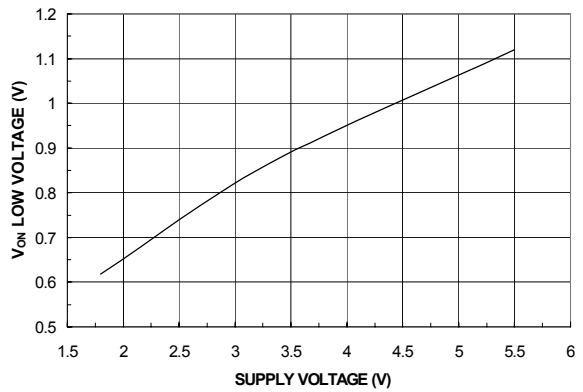

Figure 4.  $V_{ON}$  Low Voltage vs. Input Voltage

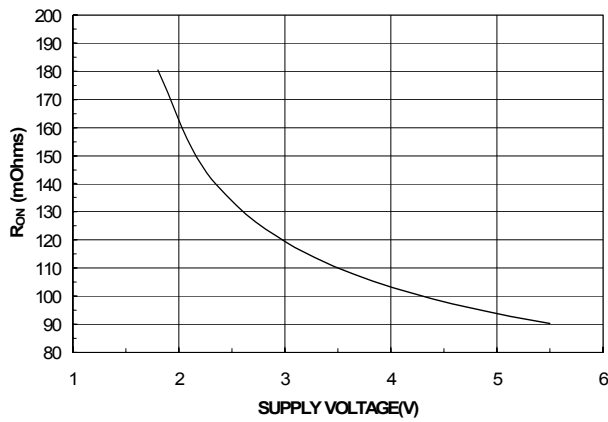

Figure 5.  $R_{ON}$  vs.  $V_{IN}$

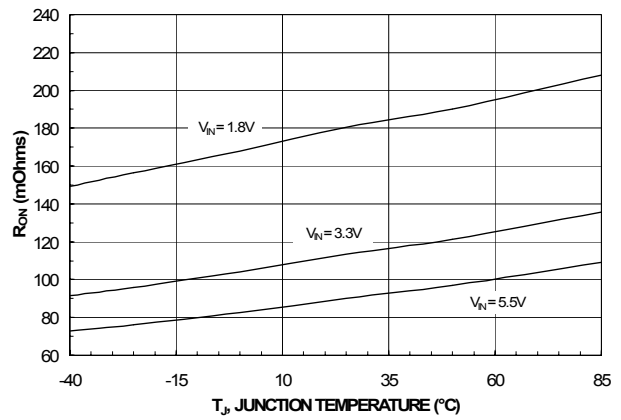

Figure 6.  $R_{ON}$  vs. Temperature

### Typical Characteristics

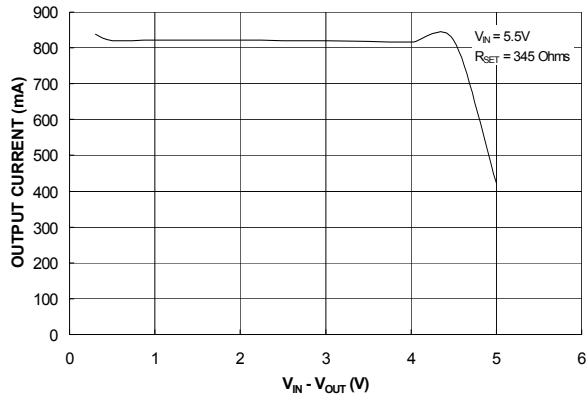

Figure 7. Current Limit vs. Output Voltage

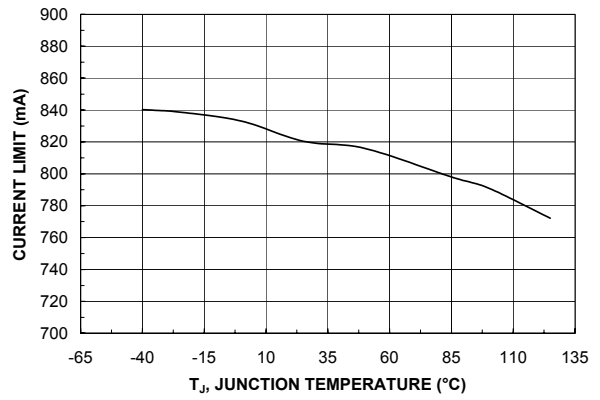

Figure 8. Current Limit vs. Temperature

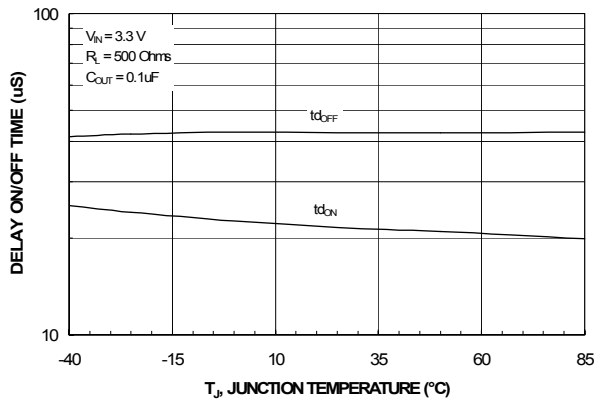

Figure 9.  $t_{dON}$  /  $t_{dOFF}$  vs. Temperature

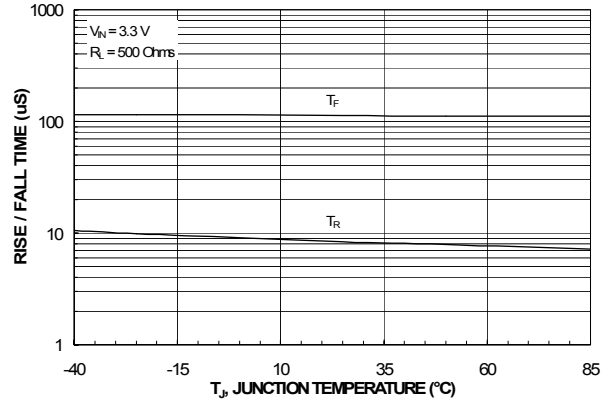

Figure 10.  $T_{RISE}$  /  $T_{FALL}$  vs. Temperature

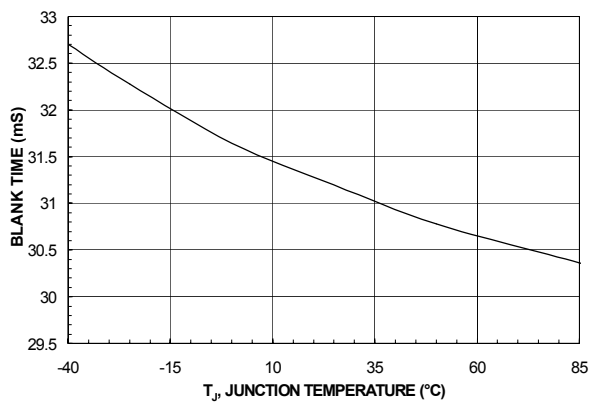

Figure 11.  $T_{BLANK}$  vs. Temperature

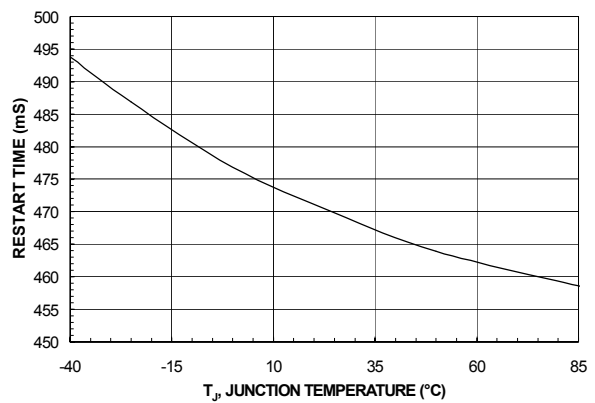

Figure 12.  $T_{RESTART}$  vs. Temperature

### Typical Characteristics

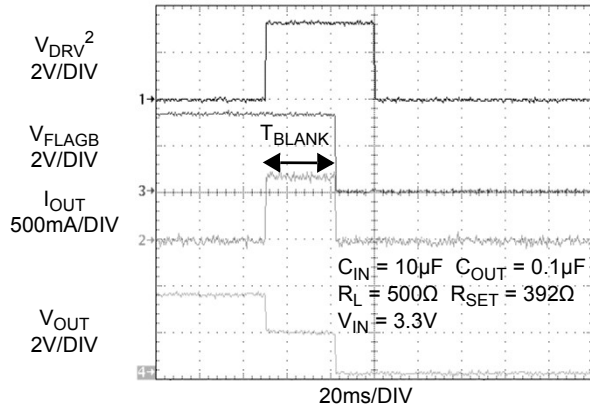

Figure 13.  $T_{BLANK}$  Response

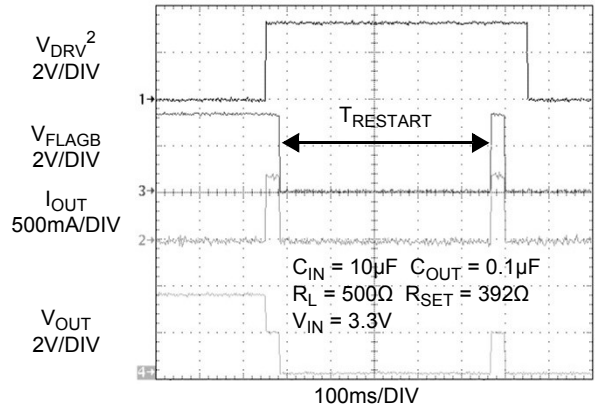

Figure 14.  $T_{RESTART}$  Response

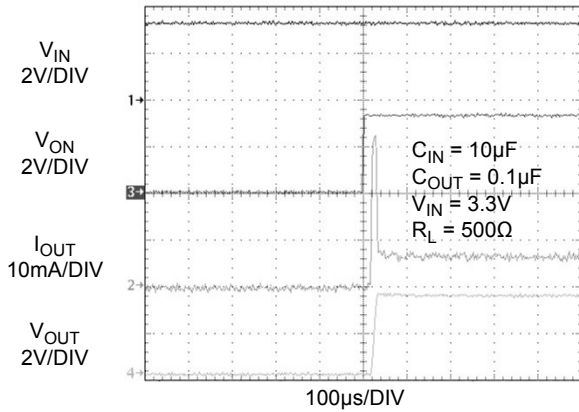

Figure 15.  $t_{dON}$  Response

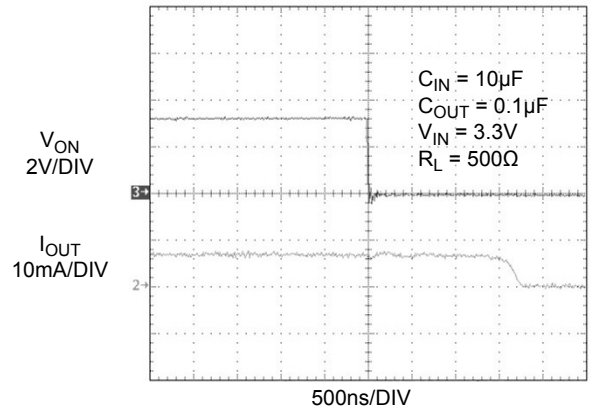

Figure 16.  $t_{dOFF}$  Response

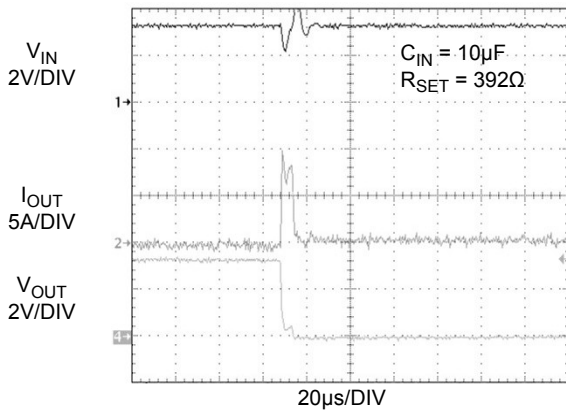

Figure 17. Short Circuit Response Time (Output shorted to GND)

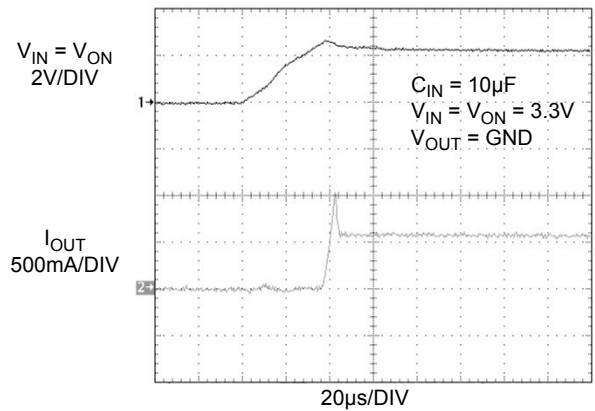

Figure 18. Current Limit Response Time (Switch is powered into a short)

### Typical Characteristics

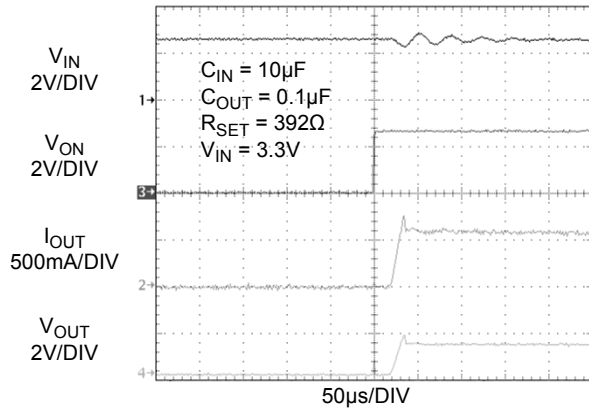

Figure 19. Current Limit Response Time  
(Output is loaded by 2.2Ω,  $C_{OUT} = 0.1\mu F$ )

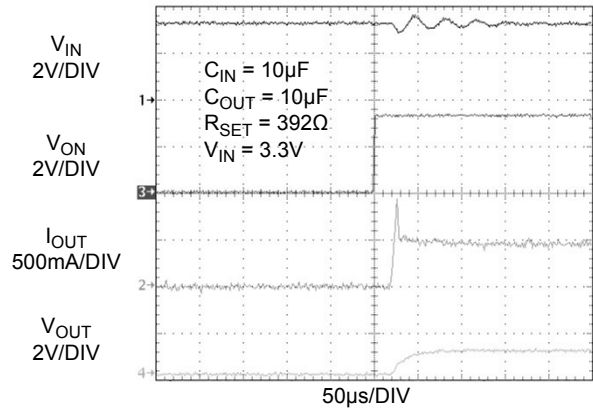

Figure 20. Current Limit Response Time  
(Output is loaded by 2.2Ω,  $C_{OUT} = 10\mu F$ )

**Note 2:**  $V_{DRV}$  signal forces the device to go into overcurrent condition by loading.

## Description of Operation

The FPF2163, FPF2164, and FPF2165 are current limited switches that protect systems and loads which can be damaged or disrupted by the application of high currents. The core of each device is a 0.12Ω P-channel MOSFET and a controller capable of functioning over a wide input operating range of 1.8-5.5V. The controller protects against system malfunctions through current limiting, undervoltage lockout and thermal shutdown. The current limit is adjustable from 150mA to 1.5A through the selection of an external resistor.

### On/Off Control

The ON pin controls the state of the switch. When ON is high, the switch is in the on state. Activating ON continuously holds the switch in the on state so long as there is no fault. For all versions, an undervoltage on  $V_{IN}$  or a junction temperature in excess of 140°C overrides the ON control to turn off the switch. In addition, excessive currents will cause the switch to turn off in the FPF2163 and FPF2164. The FPF2163 has an Auto-Restart feature which will automatically turn the switch on again after 450ms. For the FPF2164, the ON pin must be toggled to turn-on the switch again. The FPF2165 does not turn off in response to an over current condition but instead remains operating in a constant current mode so long as ON is active and the thermal shutdown or undervoltage lockout have not activated.

The ON pin control voltage and  $V_{IN}$  pin have independent recommended operating ranges. The ON pin voltage can be driven by a voltage level higher than the input voltage.

### Fault Reporting

Upon the detection of an over-current, an input undervoltage, or an over-temperature condition, the FLAGB signals the fault mode by activating LO. For the FPF2163 and FPF2164, the FLAGB goes LO at the end of the blanking time while FLAGB goes LO immediately for the FPF2165. FLAGB remains LO through the Auto-Restart Time for the FPF2165. For the FPF2164, FLAGB is latched LO and ON must be toggled to release it. With the FPF2165, FLAGB is LO during the faults and immediately returns HI at the end of the fault condition. FLAGB is an open-drain MOSFET which requires a pull-up resistor between  $V_{IN}$  and FLAGB. During shutdown, the pull-down on FLAGB is disabled to reduce current draw from the supply.

### Current Limiting

The current limit ensures that the current through the switch doesn't exceed a maximum value while not limiting at less than a minimum value. The current at which the parts will limit is adjustable through the selection of an external resistor connected to ISET. Information for selecting the resistor is found in the Application Info section. The FPF2163 and FPF2164 have a blanking time of 30ms, nominally, during which the switch will act as a constant current source. At the end of the blanking time, the switch will be turned-off. The FPF2165 has no current limit blanking period so it will remain in a constant current state until the ON pin is deactivated or the thermal shutdown turns-off the switch.

For preventing the switch from large power dissipation during heavy load a short circuit detection feature is introduced. Short circuit condition is detected by observing the output voltage. The switch is put into short circuit current limiting mode if the

switch is loaded with a heavy load. When the output voltage drops below  $V_{SCTH}$ , short circuit detection threshold voltage, the current limit value re-conditioned and short circuit current limit value is decreased to 62.5% of the current limit value. This keeps the power dissipation of the part below a certain limit even at dead short conditions at 5.5V input voltage. The  $V_{SCTH}$  value is set to be 1V. At around 1.1V of output voltage the switch is removed from short circuit current limiting mode and the current limit is set to the current limit value.

### Undervoltage Lockout

The undervoltage lockout turns-off the switch if the input voltage drops below the undervoltage lockout threshold. With the ON pin active the input voltage rising above the undervoltage lockout threshold will cause a controlled turn-on of the switch which limits current over-shoots.

### Reverse Current Blocking

The entire FPF2163/65 family has a Reverse Current Blocking feature that protects input source against current flow from output to input. For a standard USB power design, this is an important feature which protects the USB host from being damaged due to reverse current flow on  $V_{BUS}$ . The reverse current blocking feature is active when the load switch is turned off.

If ON pin is LO and output voltage become greater than input voltage, no current can flow from the output to the input. The FLAGB operation is independent of the Reverse Current blocking feature and will not report a fault condition if this feature is activated.

### Thermal Shutdown

The thermal shutdown protects the die from internally or externally generated excessive temperatures. During an over-temperature condition the FLAGB is activated and the switch is turned-off. The switch automatically turns-on again if temperature of the die drops below the threshold temperature.

### Timing Diagram

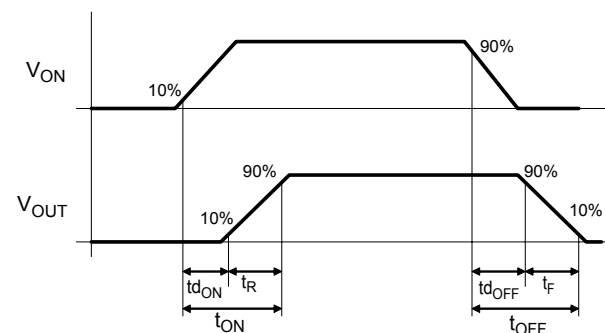

where:

- $t_{d_{ON}}$  = Delay On Time
- $t_r$  =  $V_{OUT}$  Rise Time
- $t_{ON}$  = Turn On Time
- $t_{d_{OFF}}$  = Delay Off Time
- $t_f$  =  $V_{OUT}$  Fall Time
- $t_{OFF}$  = Turn Off Time

## Application Information

### Typical Application

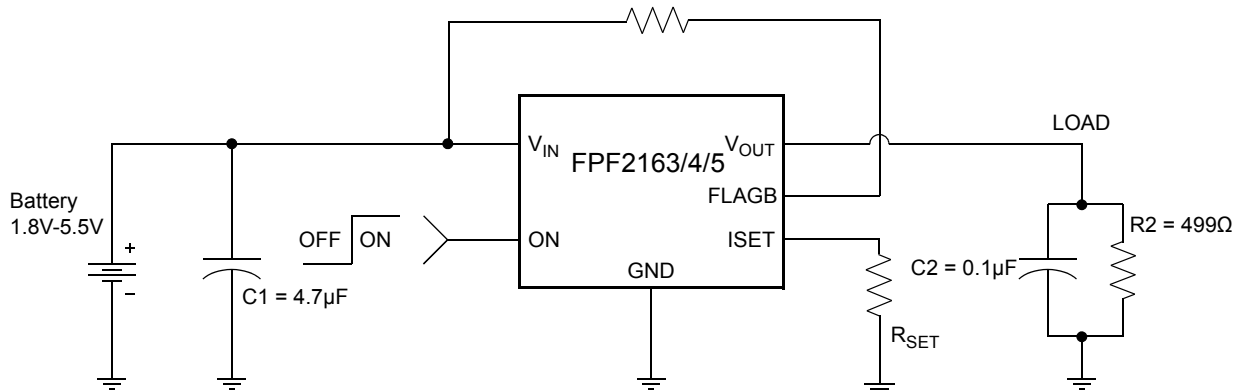

### Setting Current Limit

The FPF2163, FPF2164, and FPF2165 have a current limit which is set with an external resistor connected between ISET and GND. This resistor is selected by using the following equation,

$$R_{SET} = \frac{275.6}{I_{LIM}} \quad (1)$$

$R_{SET}$  is in Ohms and that of  $I_{LIM}$  is Amps

The table below can also be used to select  $R_{SET}$ . A typical application would be the 500mA current that is required by a single USB port. Using the table below an appropriate selection for the  $R_{SET}$  resistor would be 394Ω. This will ensure that the port load could draw 525mA, but not more than 875mA. Likewise for a dual port system, an  $R_{SET}$  of 185Ω would always deliver at least 1125mA and never more than 1875mA

### Current Limit Various $R_{SET}$ Values

$R_{SET}$ [Ω]	Min. Current Limit [mA]	Typ. Current Limit [mA]	Max. Current Limit [mA]
185	1125	1500	1875
220	938	1250	1562
275	750	1000	1250
306	675	900	1125
345	600	800	1000
394	525	700	875
460	450	600	750
550	375	500	625
610	338	450	563
690	300	400	500
790	263	350	438
920	225	300	375
1100	188	250	313
1380	150	200	250
1830	113	150	188

### Input Capacitor

To limit the voltage drop on the input supply caused by transient in-rush currents when the switch is turned on into a discharged load capacitor or a short-circuit, a capacitor needs to be placed between  $V_{IN}$  and GND. A 4.7µF ceramic capacitor,  $C_{IN}$ , must be placed close to the  $V_{IN}$  pin. A higher value of  $C_{IN}$  can be used to further reduce the voltage drop experienced as the switch is turned on into a large capacitive load.

### Output Capacitor

A 0.1µF capacitor  $C_{OUT}$ , should be placed between  $V_{OUT}$  and GND. This capacitor will prevent parasitic board inductances from forcing  $V_{OUT}$  below GND when the switch turns-off. For the FPF2163 and FPF2164, the total output capacitance needs to be kept below a maximum value,  $C_{OUT(max)}$ , to prevent the part from registering an over-current condition and turning-off the switch. The maximum output capacitance can be determined from the following formula,

$$C_{OUT(max)} = \frac{I_{LIM(max)} \times t_{BLANK(min)}}{V_{IN}} \quad (2)$$

### Power Dissipation

During normal operation as a switch, the power dissipated in the part will depend upon the level at which the current limit is set. The maximum allowed setting for the current limit is 1.5A and this will result in a power dissipation of,

$$P = (I_{LIM})^2 \times R_{DS} = (1.5)^2 \times 0.12 = 270mW \quad (3)$$

If the part goes into current limit the maximum power dissipation will occur when the output is shorted to ground. For the FPF2163, the power dissipation will scale by the Auto-Restart Time,  $t_{RSTRT}$ , and the Over Current Blanking Time,  $t_{BLANK}$ , so that the maximum power dissipated is,

$$P(max) = \frac{t_{BLANK}}{t_{BLANK} + t_{RSTRT}} \times V_{IN(max)} \times I_{LIM(max)}$$

$$= \frac{30}{30 + 450} \times 5.5 \times 1.5 = 515.6mW \quad (4)$$

This is more power than the package can dissipate, but the thermal shutdown of the part will activate to protect the part from damage due to excessive heating. When using the FPF2164, attention must be given to the manual resetting of the part. The junction temperature will only be able to increase to the thermal shutdown threshold. Once this temperature has been reached, toggling ON will not turn-on the switch until the junction temperature drops. For the FPF2165, a short on the output will cause the part to operate in a constant current state dissipating a worst case power of,

$$\begin{aligned} P(\text{max}) &= V_{\text{IN}}(\text{max}) \times I_{\text{LIM}}(\text{max}) & (5) \\ &= 5.5 \times 1.5 = 8.25\text{W} \end{aligned}$$

This large amount of power will activate the thermal shutdown and the part will cycle in and out of thermal shutdown so long as the ON pin is active and the short is present.

### Board Layout

For best performance, all traces should be as short as possible. To be most effective, the input and output capacitors should be placed close to the device to minimize the effects that parasitic trace inductances may have on normal and short-circuit operation. Using wide traces for  $V_{\text{IN}}$ ,  $V_{\text{OUT}}$  and GND will help minimize parasitic electrical effects along with minimizing the case to ambient thermal impedance.

The middle pad (pin 7) should be connected to the GND plate of PCB for improving thermal performance of the load switch. An improper layout could result higher junction temperature and triggering the thermal shutdown protection feature. This concern applies when the switch is set at higher current limit value and an overcurrent condition occurs. In this case power dissipation of the switch ( $P_{\text{D}} = (V_{\text{IN}} - V_{\text{OUT}}) \times I_{\text{LIM}}(\text{max})$ ) could exceed the maximum absolute power dissipation of 1.2W.

### Dimensional Outline and Pad Layout

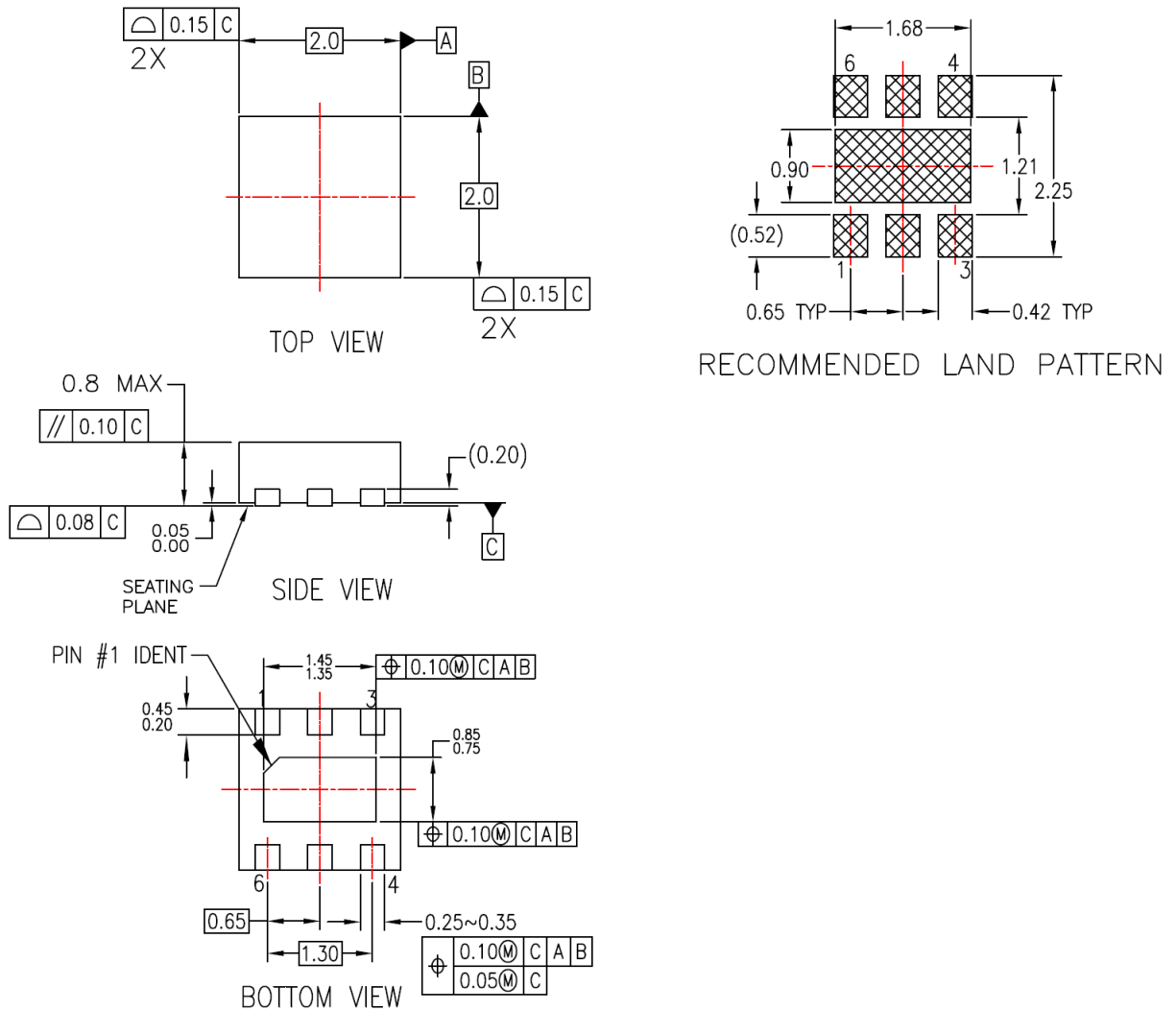

**NOTES:**





- A. NON-CONFORMS TO JEDEC REGISTRATION,
- B. DIMENSIONS ARE IN MILLIMETERS.
- C. DIMENSIONS AND TOLERANCES PER ASME Y14.5M, 1994

MLP06KrevA



**TRADEMARKS**

The following includes registered and unregistered trademarks and service marks, owned by Fairchild Semiconductor and/or its global subsidiaries, and is not intended to be an exhaustive list of all such trademarks.

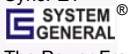
- |   |   |   |   |
|---|---|---|---|
| Build it Now™   | FRFET®  | Programmable Active Droop™  | the power™  |
| CorePLUS™   | Global Power ResourceSM   | QFET®   | franchise   |
| CorePOWER™  | Green FPS™  | QS™   | TinyBoost™  |
| CROSSVOLT™  | Green FPS™ e-Series™  | Quiet Series™   | TinyBuck™   |
| CTL™  | GTO™  | RapidConfigure™   | TinyLogic®  |
| Current Transfer Logic™   | IntelliMAX™   |  ™ | TinyOPTO™   |
| EcoSPARK®   | ISOPLANAR™  | Saving our world, 1mW/W/kW at a time™   | TinyPower™  |
| EfficientMax™   | MegaBuck™   | SmartMax™   | TinyPWM™  |
| EZSWITCH™ *   | MICROCOUPLER™   | SMART START™  | TinyWire™   |
|  ™ | MicroFET™   | SPM®  | µSerDes™  |
|  ™ | MillerDrive™  | STEALTH™  |  ™ |
| Fairchild®  | MotionMax™  | SuperFET™   | UHC®  |
| Fairchild Semiconductor®  | Motion-SPM™   | SuperSOT™_3   | Ultra FRFET™  |
| FACT Quiet Series™  | OPTOLOGIC®  | SuperSOT™_6   | UniFET™   |
| FACT®   | OPTOPLANAR®   | SuperSOT™_8   | VCX™  |
| FAST®   |  ™ | SupreMOS™   | VisualMax™  |
| FastvCore™  | PDP SPM™  | SyncFET™  | XS™   |
| FlashWriter® *  | Power-SPM™  |  ™ |   |
| FPS™  | PowerTrench®  | The Power Franchise®  |   |
| F-PFS™  | PowerXS™  |   |   |

\* EZSWITCH™ and FlashWriter® are trademarks of System General Corporation, used under license by Fairchild Semiconductor.

**DISCLAIMER**

FAIRCHILD SEMICONDUCTOR RESERVES THE RIGHT TO MAKE CHANGES WITHOUT FURTHER NOTICE TO ANY PRODUCTS HEREIN TO IMPROVE RELIABILITY, FUNCTION, OR DESIGN. FAIRCHILD DOES NOT ASSUME ANY LIABILITY ARISING OUT OF THE APPLICATION OR USE OF ANY PRODUCT OR CIRCUIT DESCRIBED HEREIN; NEITHER DOES IT CONVEY ANY LICENSE UNDER ITS PATENT RIGHTS, NOR THE RIGHTS OF OTHERS. THESE SPECIFICATIONS DO NOT EXPAND THE TERMS OF FAIRCHILD'S WORLDWIDE TERMS AND CONDITIONS, SPECIFICALLY THE WARRANTY THEREIN, WHICH COVERS THESE PRODUCTS.

**LIFE SUPPORT POLICY**

FAIRCHILD'S PRODUCTS ARE NOT AUTHORIZED FOR USE AS CRITICAL COMPONENTS IN LIFE SUPPORT DEVICES OR SYSTEMS WITHOUT THE EXPRESS WRITTEN APPROVAL OF FAIRCHILD SEMICONDUCTOR CORPORATION.

As used herein:

- Life support devices or systems are devices or systems which, (a) are intended for surgical implant into the body or (b) support or sustain life, and (c) whose failure to perform when properly used in accordance with instructions for use provided in the labeling, can be reasonably expected to result in a significant injury of the user.
- A critical component in any component of a life support, device, or system whose failure to perform can be reasonably expected to cause the failure of the life support device or system, or to affect its safety or effectiveness.

**ANTI-COUNTERFEITING POLICY**

Fairchild Semiconductor Corporation's Anti-Counterfeiting Policy. Fairchild's Anti-Counterfeiting Policy is also stated on our external website, www.fairchildsemi.com, under Sales Support.

Counterfeiting of semiconductor parts is a growing problem in the industry. All manufactures of semiconductor products are experiencing counterfeiting of their parts. Customers who inadvertently purchase counterfeit parts experience many problems such as loss of brand reputation, substandard performance, failed application, and increased cost of production and manufacturing delays. Fairchild is taking strong measures to protect ourselves and our customers from the proliferation of counterfeit parts. Fairchild strongly encourages customers to purchase Fairchild parts either directly from Fairchild or from Authorized Fairchild Distributors who are listed by country on our web page cited above. Products customers buy either from fairchild directly or from Authorized Fairchild Distributors are genuine parts, have full traceability, meet Fairchild's quality standards for handling and storage and provide access to Fairchild's full range of up-to-date technical and product information. Fairchild and our Authorized Distributors will stand behind all warranties and will appropriately address and warranty issues that may arise. Fairchild will not provide any warranty coverage or other assistance for parts bought from Unauthorized Sources. Fairchild is committed to combat this global problem and encourage our customers to do their part in stopping this practice by buying direct or from authorized distributors.

**PRODUCT STATUS DEFINITIONS**

**Definition of Terms**

Datasheet Identification	Product Status	Definition
Advance Information	Formative / In Design	Datasheet contains the design specifications for product development. Specifications may change in any manner without notice.
Preliminary	First Production	Datasheet contains preliminary data; supplementary data will be published at a later date. Fairchild Semiconductor reserves the right to make changes at any time without notice to improve design.
No Identification Needed	Full Production	Datasheet contains final specifications. Fairchild Semiconductor reserves the right to make changes at any time without notice to improve the design.
Obsolete	Not In Production	Datasheet contains specifications on a product that is discontinued by Fairchild Semiconductor. The datasheet is for reference information only.

Rev. I37

ON Semiconductor and  are trademarks of Semiconductor Components Industries, LLC dba ON Semiconductor or its subsidiaries in the United States and/or other countries. ON Semiconductor owns the rights to a number of patents, trademarks, copyrights, trade secrets, and other intellectual property. A listing of ON Semiconductor's product/patent coverage may be accessed at [www.onsemi.com/site/pdf/Patent-Marking.pdf](http://www.onsemi.com/site/pdf/Patent-Marking.pdf). ON Semiconductor reserves the right to make changes without further notice to any products herein. ON Semiconductor makes no warranty, representation or guarantee regarding the suitability of its products for any particular purpose, nor does ON Semiconductor assume any liability arising out of the application or use of any product or circuit, and specifically disclaims any and all liability, including without limitation special, consequential or incidental damages. Buyer is responsible for its products and applications using ON Semiconductor products, including compliance with all laws, regulations and safety requirements or standards, regardless of any support or applications information provided by ON Semiconductor. "Typical" parameters which may be provided in ON Semiconductor data sheets and/or specifications can and do vary in different applications and actual performance may vary over time. All operating parameters, including "Typicals" must be validated for each customer application by customer's technical experts. ON Semiconductor does not convey any license under its patent rights nor the rights of others. ON Semiconductor products are not designed, intended, or authorized for use as a critical component in life support systems or any FDA Class 3 medical devices or medical devices with a same or similar classification in a foreign jurisdiction or any devices intended for implantation in the human body. Should Buyer purchase or use ON Semiconductor products for any such unintended or unauthorized application, Buyer shall indemnify and hold ON Semiconductor and its officers, employees, subsidiaries, affiliates, and distributors harmless against all claims, costs, damages, and expenses, and reasonable attorney fees arising out of, directly or indirectly, any claim of personal injury or death associated with such unintended or unauthorized use, even if such claim alleges that ON Semiconductor was negligent regarding the design or manufacture of the part. ON Semiconductor is an Equal Opportunity/Affirmative Action Employer. This literature is subject to all applicable copyright laws and is not for resale in any manner.

## PUBLICATION ORDERING INFORMATION

### LITERATURE FULFILLMENT:



Literature Distribution Center for ON Semiconductor  
19521 E. 32nd Pkwy, Aurora, Colorado 80011 USA  
**Phone:** 303-675-2175 or 800-344-3860 Toll Free USA/Canada  
**Fax:** 303-675-2176 or 800-344-3867 Toll Free USA/Canada  
**Email:** [orderlit@onsemi.com](mailto:orderlit@onsemi.com)

**N. American Technical Support:** 800-282-9855 Toll Free  
USA/Canada  
**Europe, Middle East and Africa Technical Support:**  
Phone: 421 33 790 2910  
**Japan Customer Focus Center**  
Phone: 81-3-5817-1050

**ON Semiconductor Website:** [www.onsemi.com](http://www.onsemi.com)  
**Order Literature:** <http://www.onsemi.com/orderlit>  
For additional information, please contact your local  
Sales Representative

## Looking for pricing, stock, or lifecycle information?

Click below to explore more details on WIN SOURCE:

-  [View FPF2165 on WIN SOURCE](#)
-  [Fairchild/ON Semiconductor Information](#)

## Optimize Your Supply Chain with WIN SOURCE Solutions

-  Global Sourcing Solution
-  Obsolete Management
-  Cost Control Management
-  Shortage Management
-  Alternative Solution
-  Excess Inventory Management