



# THE DATASHEET OF HDC3021DEHR



# HDC302x 0.5%RH Digital Relative Humidity Sensor, 0.19%RH/yr Long Term Drift, 4s Response, Low-Power, Offset Error Correction, 0.1°C Temperature Sensor

## 1 Features

- Relative humidity (RH) sensor:
  - Operating range: 0% to 100%
  - Accuracy:  $\pm 0.5\%$  typical
  - Offset Error Correction: reduces offset to return device to within accuracy specification
  - Long-term drift: 0.19%RH/yr
  - Condensation protection with integrated heater
- Temperature sensor:
  - Operating range:  $-40^{\circ}\text{C}$  to  $125^{\circ}\text{C}$
  - Accuracy:  $\pm 0.1^{\circ}\text{C}$  typical
- NIST traceability: relative humidity & temperature
- Low power: average current 0.4  $\mu\text{A}$
- I<sup>2</sup>C interface compatibility up to 1-MHz speeds
  - Four selectable I<sup>2</sup>C addresses
  - Data protection through CRC checksum
- Supply voltage: 1.62 V to 5.50 V
- Available auto measurement mode
- Programmable interrupts
- Programmable RH and Temp measurement offset
- Factory-installed polyimide tape assembly cover
- Factory-installed IP67 rated environmental cover

## 2 Applications

- Washer & dryer
- Refrigerator & freezer
- Industrial transport
- Cold Chain asset tracking & data logger
- IoT environmental sensors
- Air quality and gas detection
- Humidifier/dehumidifier
- Thermostat
- CPAP and ventilator
- Water leak detector
- IP Camera

## 3 Description

The HDC302x is an integrated capacitive based relative humidity (RH) and temperature sensor. It provides high accuracy measurements over a wide supply range (1.62 V – 5.5 V), along with ultra-low power consumption in a compact 2.5-mm × 2.5-mm package. Both the temperature and humidity sensors are 100% tested and trimmed on a production setup that is NIST traceable and verified with equipment that is calibrated to ISO/IEC 17025 standards.

Offset Error Correction reduces RH sensor offset due to aging, exposure to extreme operating conditions, and contaminants to return device to within accuracy specifications. For battery IoT applications, auto measurement mode and ALERT feature enable low system power by maximizing MCU sleep time. There are four different I<sup>2</sup>C addresses that support speeds up to 1 MHz. A heating element is available to dissipate condensation and moisture.

The HDC3020 is an open cavity package without protective cover. Two device variants have a cover option to protect the open cavity RH sensor: HDC3021 and HDC3022. HDC3021 has removable protective tape to allow conformal coatings and PCB wash. HDC3022 has a permanent IP67 filter membrane to protect against dust, water and PCB wash.

### Package Information

PART NUMBER	PACKAGE <sup>(1)</sup>	BODY SIZE (NOM)
HDC3020	WSON (8)	2.50 mm × 2.50 mm
HDC3021		
HDC3022		

- (1) For all available packages, see the orderable addendum at the end of the data sheet.

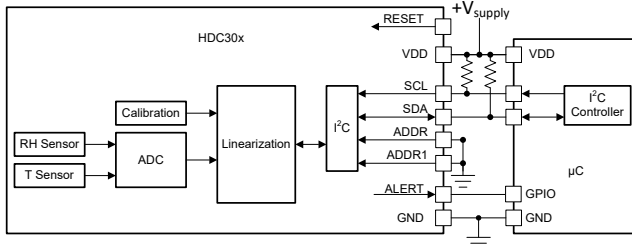

Typical Application

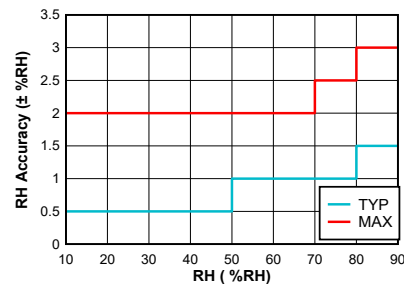

Relative Humidity (%RH) Accuracy



## Table of Contents

<b>1 Features</b> .....	1	8.3 Feature Description.....	12
<b>2 Applications</b> .....	1	8.4 Device Functional Modes.....	15
<b>3 Description</b> .....	1	8.5 Programming.....	15
<b>4 Revision History</b> .....	2	<b>9 Application and Implementation</b> .....	32
<b>5 Device Comparison</b> .....	3	9.1 Application Information.....	32
<b>6 Pin Configuration and Functions</b> .....	4	9.2 Typical Application.....	32
<b>7 Specifications</b> .....	5	9.3 Power Supply Recommendations.....	34
7.1 Absolute Maximum Ratings.....	5	9.4 Layout.....	34
7.2 ESD Ratings.....	5	<b>10 Device and Documentation Support</b> .....	37
7.3 Recommended Operating Conditions.....	5	10.1 Documentation Support.....	37
7.4 Thermal Information.....	5	10.2 Receiving Notification of Documentation Updates.....	37
7.5 Electrical Characteristics.....	6	10.3 Support Resources.....	37
7.6 I <sup>2</sup> C Interface Timing.....	8	10.4 Trademarks.....	37
7.7 Timing Diagram.....	9	10.5 Electrostatic Discharge Caution.....	37
7.8 Typical Characteristics.....	10	10.6 Glossary.....	37
<b>8 Detailed Description</b> .....	12	<b>11 Mechanical, Packaging, and Orderable Information</b> .....	37
8.1 Overview.....	12		
8.2 Functional Block Diagram.....	12		

## 4 Revision History

Changes from Revision B (August 2022) to Revision C (December 2022)	Page
• Changed data sheet status from Production Mixed to Production Data.....	1
• Removed the preview note from the HDC3022 device.....	1

Changes from Revision A (September 2021) to Revision B (August 2022)	Page
• Changed data sheet status from Advanced Information to Production Mixed.....	1
• Changed the device status on the HDC3020 and HDC3021 from Advanced Information to Production Data ..	1
• Renamed drift correct to offset error correction.....	1
• Removed that ADDR and ADDR1 pins may be left floating. They should NOT be left floating.....	4
• Updated electrical specifications to reflect pre-production testing characterization.....	5
• Added heater commands.....	18
• Corrected command code to read Manufacturing ID hex code LSB from: 80 to: 81.....	18
• Added additional trigger on demand command codes: 0x2C06, 0x2C0D, 0x2C10.....	18
• Moved the <i>Power Supply Recommendations</i> and <i>Layout</i> sections to the <i>Application and Implementation</i> section.....	34
• Changed rehydration recommendation to 25°C and 50%RH for 5 days.....	36

## 5 Device Comparison

**Table 5-1. HDC302x Device Comparison**

DEVICE	SENSOR CAVITY PROTECTION	PACKAGE TYPE
HDC3020DEFR	None	WSON
HDC3021DEHR	Removable polyimide tape	
HDC3022DEJR	Permanent IP67 filter membrane	

**Table 5-2. HDC3 Family Differences**

FUNCTION	HDC302x	HDC302x-Q1	HDC31xx <sup>(1)</sup>	HDC31xx-Q1 <sup>(1)</sup>
Rating	Commercial	Automotive	Commercial	Automotive
Interface	I <sup>2</sup> C, 4 addresses		RH and Temp analog output	
Package	2.5 mm × 2.5 mm	2.5 mm × 2.5 mm with wettable flanks option	2.5 mm × 2.5 mm	2.5 mm × 2.5 mm with wettable flanks
Sensor cavity protection options	•	•	•	•
Extended Features: <ul style="list-style-type: none"> <li>• Offset Error Correction</li> <li>• Heater</li> <li>• Auto measurement</li> <li>• Measurement Duration Options</li> <li>• Alert (RH and T high and low) interrupt</li> <li>• Programmable Offset</li> </ul>	•	•		

(1) Preview only

## 6 Pin Configuration and Functions

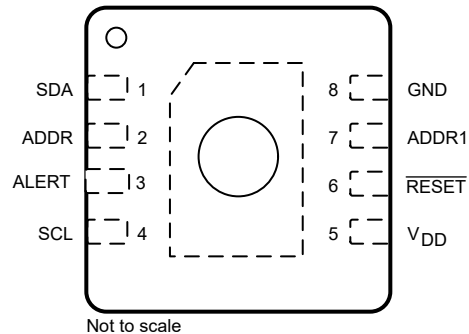

Figure 6-1. HDC302x DEF, DEH, DEJ Package 8-Pin WSON Transparent Top View

Table 6-1. Pin Functions

PIN		TYPE <sup>(1)</sup>	DESCRIPTION
NAME	NO.		
ADDR	2	I	I <sup>2</sup> C Device Address Pin. For device addresses 0x44 and 0x45, ADDR1 voltage must be LOW. 0x44 requires ADDR voltage to be LOW. 0x45 requires ADDR voltage to be HIGH.
ADDR1	7	I	I <sup>2</sup> C Device Address Pin. For device addresses 0x46 and 0x47, ADDR1 voltage must be HIGH. 0x46 requires ADDR voltage to be LOW. 0x47 requires ADDR voltage to be HIGH.
ALERT	3	O	Interrupt Pin. Push-Pull Output. If not used, must be left floating.
GND	8	G	Ground
RESET	6	I	Reset Pin. Active Low. If not used, leave floating or tie to V <sub>DD</sub> .
SCL	4	I	Serial clock line for I <sup>2</sup> C, open-drain; requires a pullup resistor to V <sub>DD</sub> .
SDA	1	I/O	Serial data line for I <sup>2</sup> C, open-drain; requires a pullup resistor to V <sub>DD</sub> .
V <sub>DD</sub>	5	P	Supply Voltage. From 1.62 V to 5.50 V.

- (1) Type:  
 G = Ground  
 I = Input  
 O = Output  
 P = Power

## 7 Specifications

### 7.1 Absolute Maximum Ratings

over operating free-air temperature range (unless otherwise noted)<sup>(1)</sup>

PARAMETER		MIN	MAX	UNIT
V <sub>DD</sub>	Applied Voltage on VDD pin	-0.3	6.0	V
SCL	Applied Voltage on SCL pin	-0.3	6.0	V
SDA	Applied Voltage on SDA pin	-0.3	6.0	V
ADDR	Applied Voltage on ADDR pin	-0.3	6.0	V
ADDR1	Applied Voltage on ADDR1 pin	-0.3	V <sub>DD</sub> + 0.3	V
ALERT	Applied Voltage on ALERT pin	-0.3	V <sub>DD</sub> + 0.3	V
RESET	Applied Voltage on RESET pin	-0.3	V <sub>DD</sub> + 0.3	V
T <sub>J</sub>	Junction temperature	-55	150	°C
T <sub>stg</sub>	Storage temperature	-65	150	°C

- (1) Operation outside the Absolute Maximum Ratings may cause permanent device damage. Absolute Maximum Ratings do not imply functional operation of the device at these or any other conditions beyond those listed under Recommended Operating Conditions. If used outside the Recommended Operating Conditions but within the Absolute Maximum Ratings, the device may not be fully functional, and this may affect device reliability, functionality, performance, and shorten the device lifetime.

### 7.2 ESD Ratings

PARAMETER			VALUE	UNIT
V <sub>(ESD)</sub>	Electrostatic discharge	Human body model (HBM), per ANSI/ESDA/JEDEC JS-001 <sup>(1)</sup>	±2000	V
		Charged device model (CDM), per JEDEC specification JS-002 <sup>(2)</sup>	±750	

- (1) JEDEC document JEP155 states that 500-V HBM allows safe manufacturing with a standard ESD control process  
(2) JEDEC document JEP157 states that 250-V CDM allows safe manufacturing with a standard ESD control process

### 7.3 Recommended Operating Conditions

PARAMETER		MIN	MAX	UNIT
V <sub>DD</sub>	Supply voltage	1.62	5.5	V
T <sub>TEMP</sub>	Temperature Sensor - Operating free-air temperature	-40	125	°C
T <sub>RH</sub>	Relative Humidity Sensor - Operating free-air temperature	-20	80	°C
T <sub>HEATER</sub>	Integrated Heater for condensation removal - Operating free-air temperature <sup>(1)</sup>	-40	60	°C
RH <sub>OR</sub>	Relative Humidity Sensor Operating Range (Non-condensing) <sup>(1)</sup>	0	100	%RH

- (1) Prolonged operation outside the recommended temperature operating conditions and/or at >80%RH with temperature in the higher recommended operating range can result in a shift of sensor reading, with slow recovery time. Note care needs to be taken when measuring RH at <0°C due to potential for frost. See [Exposure to High Temperature and High Humidity Conditions](#) for more details.

### 7.4 Thermal Information

THERMAL METRIC <sup>(1)</sup>		HDC3x	UNIT
		DEF, DEH, and DEJ (WSON)	
		8 PINS	
R <sub>θJA</sub>	Junction-to-ambient thermal resistance	84.9	°C/W
R <sub>θJC(top)</sub>	Junction-to-case (top) thermal resistance <sup>(2)</sup>	N/A	°C/W
R <sub>θJB</sub>	Junction-to-board thermal resistance	52.0	°C/W
Ψ <sub>JT</sub>	Junction-to-top characterization parameter <sup>(2)</sup>	N/A	°C/W
Ψ <sub>JB</sub>	Junction-to-board characterization parameter	51.7	°C/W

THERMAL METRIC <sup>(1)</sup>		HDC3x	UNIT
		DEF, DEH, and DEJ (WSON)	
		8 PINS	
R <sub>θJC(bot)</sub>	Junction-to-case (bottom) thermal resistance	30.4	°C/W

- (1) For more information about traditional and new thermal metrics, see the [Semiconductor and IC Package Thermal Metrics](#) application report.
- (2) JEDEC standard JESD51-X specifies this measurement at the center position on the top surface of the package. Due to the location of the cavity opening at the center position, this measurement is not applicable.

## 7.5 Electrical Characteristics

T<sub>A</sub> = -40°C to 125°C, V<sub>DD</sub> = 1.62V to 5.50V (unless otherwise noted), Typical Specifications are T<sub>A</sub> = 25°C, V<sub>DD</sub> = 1.8V unless otherwise noted

PARAMETER		TEST CONDITIONS	MIN	TYP	MAX	UNIT
<b>Relative Humidity Sensor</b>						
RH <sub>ACC</sub>	Accuracy <sup>(3) (4)</sup>	T <sub>A</sub> = 25°C, 10% to 50% RH		±0.5	±2.0	%RH
		T <sub>A</sub> = 25°C, 10% to 70% RH		±1.0	±2.0	
		T <sub>A</sub> = 25°C, 10% to 80% RH		±1.0	±2.5	
		T <sub>A</sub> = 25°C, 10% to 90% RH		±1.5	±3.0	
RH <sub>REP</sub>	Repeatability	Low Power Mode 0 (lowest noise)		±0.02		%RH
		Low Power Mode 1		±0.02		
		Low Power Mode 2		±0.03		
		Low Power Mode 3 (lowest power)		±0.04		
RH <sub>HYS</sub>	Hysteresis <sup>(5)</sup>	10% to 90% RH		±0.8		%RH
RH <sub>RT</sub>	Response Time <sup>(6) (7)</sup>	10% to 90% RH t <sub>63%</sub> step.		4		s
RH <sub>LTD</sub>	Long-term Drift <sup>(4)</sup>			0.19		%RH/yr
<b>Temperature Sensor</b>						
T <sub>ACC</sub>	Accuracy	0°C ≤ T <sub>A</sub> ≤ 50°C		±0.1	±0.2	°C
		-40°C ≤ T <sub>A</sub> ≤ 100°C		±0.1	±0.3	
		-40°C ≤ T <sub>A</sub> < 125°C		±0.1	±0.4	
T <sub>REP</sub>	Repeatability	Low Power Mode 0 (lowest noise)		±0.04		°C
		Low Power Mode 1		±0.05		
		Low Power Mode 2		±0.06		
		Low Power Mode 3 (lowest power)		±0.08		
T <sub>RT</sub>	Response Time (stirred liquid) <sup>(6) (10)</sup>	25C < T <sub>A</sub> < 75C t <sub>63%</sub> step Roger's 4350B PCB 1.575mm thickness		2		s
T <sub>LTD</sub>	Long Term Drift				±0.03	°C/yr
<b>Sensor Timing</b>						
t <sub>meas</sub>	Measurement Duration <sup>(8)</sup>	Low Power Mode 0 (lowest noise)		12.5	14.1	ms
		Low Power Mode 1		7.5	8.4	
		Low Power Mode 2		5.0	5.7	
		Low Power Mode 3 (lowest power)		3.7	4.2	
<b>SCL, SDA Pins</b>						
V <sub>IL</sub>	LOW-level input voltage			0.3*V <sub>DD</sub>		V
V <sub>IH</sub>	HIGH-level input voltage		0.7*V <sub>DD</sub>			V
V <sub>OL</sub>	LOW-level output voltage	I <sub>OL</sub> = 3 mA			0.4	V
<b>Control Pins</b>						

$T_A = -40^{\circ}\text{C}$  to  $125^{\circ}\text{C}$ ,  $V_{DD} = 1.62\text{V}$  to  $5.50\text{V}$  (unless otherwise noted), Typical Specifications are  $T_A = 25^{\circ}\text{C}$ ,  $V_{DD} = 1.8\text{V}$  unless otherwise noted

PARAMETER		TEST CONDITIONS	MIN	TYP	MAX	UNIT
V <sub>OH</sub>	High-level Output Voltage - ALERT	I <sub>OH</sub> = -100 $\mu\text{A}$	V <sub>DD</sub> -0.2			V
	High-level Output Voltage - ALERT	I <sub>OH</sub> = -3 mA	V <sub>DD</sub> -0.4			V
V <sub>OL</sub>	Low-level Output Voltage - ALERT	I <sub>OL</sub> = 100 $\mu\text{A}$			0.2	V
	Low-level Output Voltage - ALERT	I <sub>OL</sub> = 3 mA			0.4	V
V <sub>IH</sub>	High Level Input Voltage - ADDR, ADDR1, RESET		0.7*V <sub>DD</sub>			V
V <sub>IL</sub>	Low Level Input Voltage - ADDR, ADDR1, RESET			0.3*V <sub>DD</sub>		V
I <sub>I</sub>	Input Leakage Current - ADDR and ADDR1	V <sub>I</sub> = V <sub>DD</sub> or GND	-0.5		0.5	$\mu\text{A}$
<b>Power Supply</b>						
I <sub>DD_ACTIVE</sub>	Active Current <sup>(1)</sup>	Low Power Mode 0 (lowest noise)		110	170	$\mu\text{A}$
		Low Power Mode 1		108	165	
		Low Power Mode 2		103	155	
		Low Power Mode 3 (lowest power)		99	153	
I <sub>DD_SLEEP</sub>	Sleep Current <sup>(1)</sup>	No Active Measurement trigger on demand mode		0.36	14.5	$\mu\text{A}$
		No Active Measurement, auto measurement mode		0.54	15.0	
I <sub>DD_AVG_EQN</sub>	Averaged Current Equation	measurement freq = numbers of samples per second	See <sup>(9)</sup>			
I <sub>DD_AVG</sub>	Averaged Current <sup>(1) (2)</sup>	trigger on demand mode, low Power Mode 3 (lowest Power) triggered at 1 sample per second		0.7		$\mu\text{A}$
		trigger on demand mode, low Power Mode 3 (lowest Power) triggered at 1 sample per 5 seconds		0.4		
		automeasurement mode, Low Power Mode 0 (lowest noise) 1 sample per second		1.9		
		automeasurement mode, Low Power Mode 1 1 sample per second		1.3		
		automeasurement mode, Low Power Mode 2 1 sample per second		1.0		
		automeasurement mode, low Power Mode 3 (lowest power) 1 sample per second		0.9		
		automeasurement mode, Low Power Mode 3 (lowest power) 1 sample every two seconds		0.7		
P <sub>HEATER</sub>	Heater Power <sup>(11)</sup>	Full Power 0x3FFF, V <sub>DD</sub> = 3.3V		249	368	mW
		Half Power 0x03FF, V <sub>DD</sub> = 3.3V		137	203	
		Quarter Power 0x009F, V <sub>DD</sub> = 3.3V		67	100	
V <sub>POR</sub>	Power on reset threshold voltage	supply rising		1.35		V
V <sub>BOR</sub>	Brown out detect voltage	supply falling		1.19		V
Sensor <sub>PUR</sub>	Power Up Ready	Sensor ready once V <sub>DD</sub> $\geq$ 1.62V		3.5	5.0	ms
Sensor <sub>RR</sub>	Reset Ready	Sensor ready after a reset		1.3	3.0	ms
R <sub>RESET</sub>	RESET pin internal pull up resistance			49		k $\Omega$

$T_A = -40^{\circ}\text{C}$  to  $125^{\circ}\text{C}$ ,  $V_{DD} = 1.62\text{V}$  to  $5.50\text{V}$  (unless otherwise noted), Typical Specifications are  $T_A = 25^{\circ}\text{C}$ ,  $V_{DD} = 1.8\text{V}$  unless otherwise noted

PARAMETER		TEST CONDITIONS	MIN	TYP	MAX	UNIT
$t_{\text{RESET\_NPW}}$	Negative pulse width to trigger hard reset		1			$\mu\text{S}$
<b>EEPROM (T, RH offset, and alert)</b>						
$\text{OS}_{\text{END}}$	Program Endurance		1000	50000		Cycles
$\text{OS}_{\text{RET}}$	Data Retention Time	100% Power-On hours	10	100		Years
$t_{\text{PROG}}$	Offset and Alert Programming Time			53	77	ms
$I_{\text{EEPROM}}$	EEPROM write quiescent current	No active measurement; serial bus inactive		525		$\mu\text{A}$

- (1) Does not include I<sup>2</sup>C read/write communication or pullup resistor current through SCL and SDA
- (2) Average current consumption while conversion is in progress
- (3) Excludes hysteresis and long-term drift
- (4) Based on THB (temperature humidity bias) testing using Arrhenius-Peck acceleration model. Excludes the impact of dust, gas phase solvents and other contaminants such as vapors from packaging materials, adhesives, or tapes, etc.
- (5) The hysteresis value is the difference between the RH measurement in a rising and falling RH environment, at a specific RH point
- (6) Actual response times will vary dependent on system thermal mass and air-flow
- (7) Time for the RH output to change by 63% of the total RH change after a step change in environmental humidity
- (8) Measurement duration includes the time to measure RH plus Temp
- (9)  $I_{DD\_AVG\_EQN} = \text{measurement freq} \times I_{DD\_ACTIVE} \times t_{\text{meas}} + I_{\text{sleep}} \times (1 - (\text{measurement freq} \times t_{\text{meas}}))$   
make sure units match eg. measurement frequency in Hz,  $t_{\text{meas}}$  in seconds, and all the currents in the same unit
- (10) Time for the T output to change by 63% of the total T change after a step change in environmental temperature
- (11) More details on the heater can be found in the [HDC3x Silicon User's Guide](#)

## 7.6 I<sup>2</sup>C Interface Timing

minimum and maximum specifications are over  $-40^{\circ}\text{C}$  to  $125^{\circ}\text{C}$  and  $V_{DD} = 1.62\text{V}$  to  $5.50\text{V}$  (unless otherwise noted)<sup>(1)</sup>

Parameter		FAST MODE		FAST MODE PLUS		UNIT
		MIN	MAX	MIN	MAX	
$f_{\text{(SCL)}}$	SCL operating frequency	1	400	1	1000	kHz
$t_{\text{(BUF)}}$	Bus-free time between STOP and START conditions	1.3		0.5		$\mu\text{s}$
$t_{\text{(SUSTA)}}$	Repeated START condition setup time	0.6		0.26		$\mu\text{s}$
$t_{\text{(HDSTA)}}$	Hold time after repeated START condition. After this period, the first clock is generated.	0.6		0.26		$\mu\text{s}$
$t_{\text{(SUSTO)}}$	STOP condition setup time	0.6		0.26		$\mu\text{s}$
$t_{\text{(HDDAT)}}$	Data hold time <sup>(2)</sup>	0	900	0	150	ns
$t_{\text{(SUDAT)}}$	Data setup time	100		50		ns
$t_{\text{(LOW)}}$	SCL clock low period	1.3		0.5		$\mu\text{s}$
$t_{\text{(HIGH)}}$	SCL clock high period	0.6		0.26		$\mu\text{s}$
$t_{\text{(VDAT)}}$	Data valid time (data response time) <sup>(3)</sup>		0.9		0.45	$\mu\text{s}$
$t_{\text{R}}$	SDA, SCL rise time	20	300		120	ns
$t_{\text{F}}$	SDA, SCL fall time	$20 \times (V_{DD} / 5.5 \text{ V})$	300	$20 \times (V_{DD} / 5.5 \text{ V})$	120	ns
$t_{\text{LPF}}$	Glitch suppression filter	50		50		ns

- (1) The controller and device have the same  $V_{DD}$  value.
- (2) The maximum  $t_{\text{(HDDAT)}}$  can be  $0.9 \mu\text{s}$  for fast mode, and is less than the maximum  $t_{\text{(VDAT)}}$  by a transition time.
- (3)  $t_{\text{(VDAT)}}$  = time for data signal from SCL LOW to SDA output (HIGH to LOW, depending on which is worse).

## 7.7 Timing Diagram

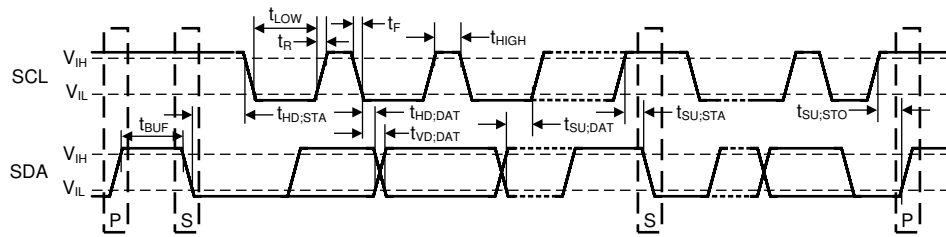

Figure 7-1. HDC302x I<sup>2</sup>C Timing Diagram

## 7.8 Typical Characteristics

Unless otherwise noted.  $T_A = 25^\circ\text{C}$ ,  $V_{DD} = 1.80\text{ V}$ .

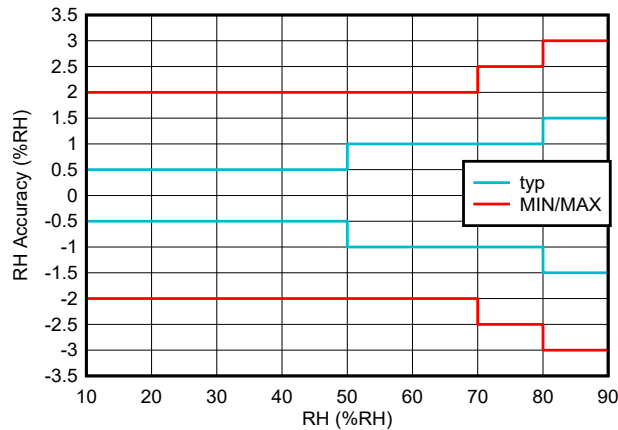

Figure 7-2. RH Accuracy vs RH

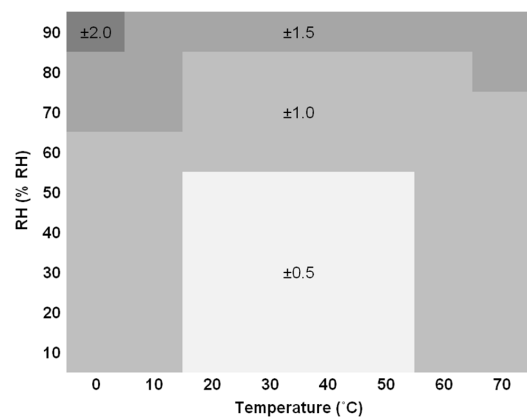

Figure 7-3. Typical RH Accuracy Across RH and Temperature

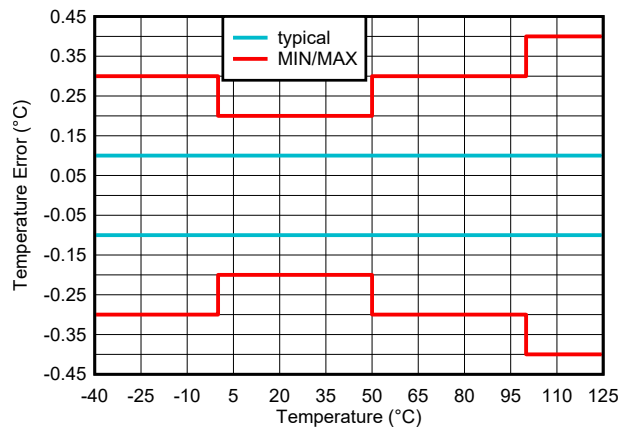

Figure 7-4. Temperature Accuracy vs Temperature

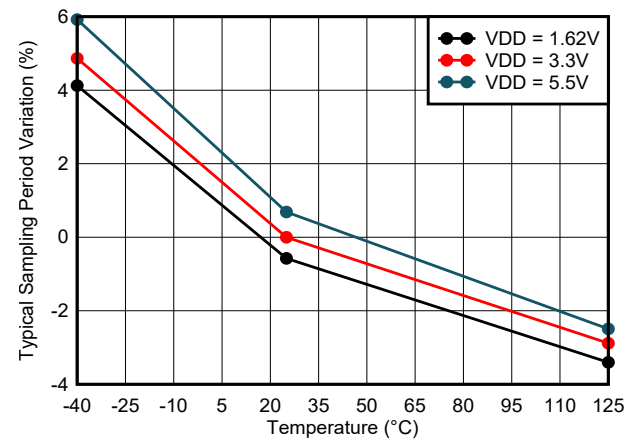

Figure 7-5. Auto Sampling Timing Variation for 1 Sample per Second

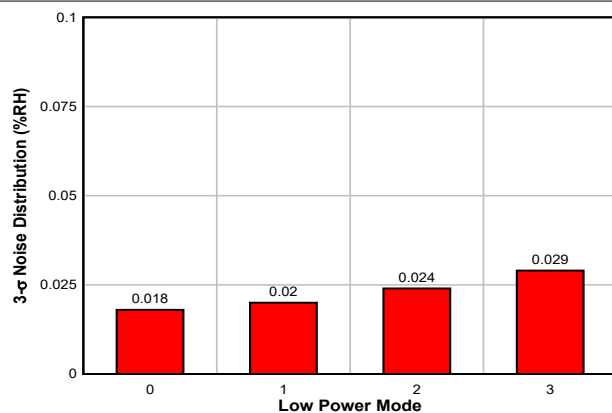

Figure 7-6. Typical RH Noise Across Low Power Modes

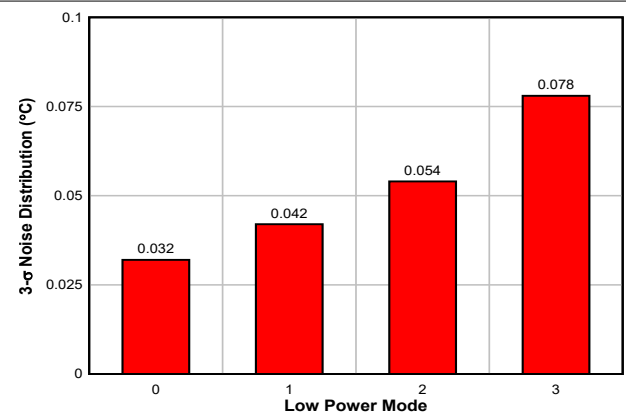

Figure 7-7. Typical Temperature Noise Across Low Power Modes

## 7.8 Typical Characteristics (continued)

Unless otherwise noted.  $T_A = 25^\circ\text{C}$ ,  $V_{DD} = 1.80\text{ V}$ .

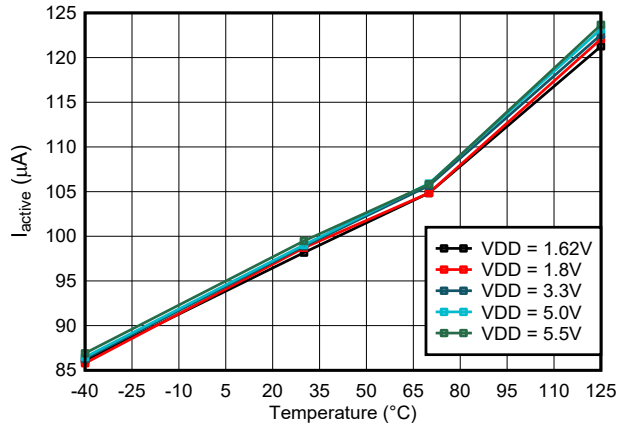

Figure 7-8.  $I_{\text{active}}$  vs Temperature Across Supply Voltages

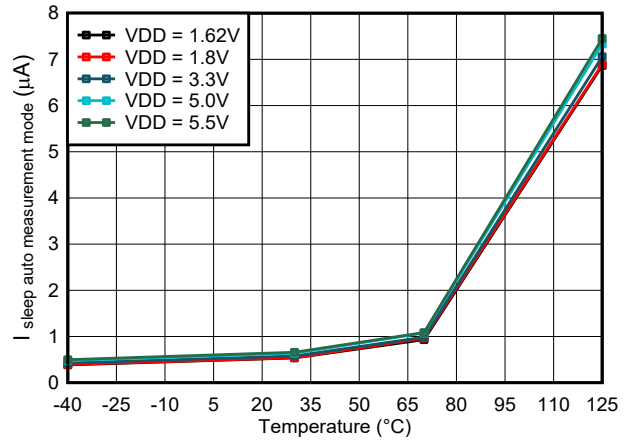

Figure 7-9.  $I_{\text{sleep}}$  Auto Measurement Mode across Temperature and Supply

## 8 Detailed Description

### 8.1 Overview

The HDC302x is an integrated interface digital sensor that incorporates both humidity-sensing and temperature-sensing elements, an analog-to-digital converter, calibration memory, and an I<sup>2</sup>C compatible interface in a 2.50-mm × 2.50-mm, 8-pin WSON package. The HDC302x also provides excellent measurement accuracy at very low power.

The HDC302x measures relative humidity through variations in the capacitance of a polymer dielectric. As with most relative humidity sensors that include this type of technology, care must be taken to ensure optimal device performance for the sensing element. This includes:

- Follow the correct storage and handling procedures during board assembly. See [HDC3x Silicon User's Guide](#) for these guidelines.
- Protect the sensor from contaminants during board assembly and operation. If that is not possible then use a protective cover option:
  - HDC3021 has removable protective tape to allow conformal coatings and PCB wash during assembly.
  - HDC3022 has a permanent IP67 filter membrane to protect against dust, condensation, water and PCB wash during both assembly and operation.
- Reduce prolonged exposure to both high temperature and humidity extremes that may impact sensor accuracy.
- Follow the correct layout guidelines for best performance. See [Optimizing Placement and Routing for Humidity Sensors](#) for these guidelines.

### 8.2 Functional Block Diagram

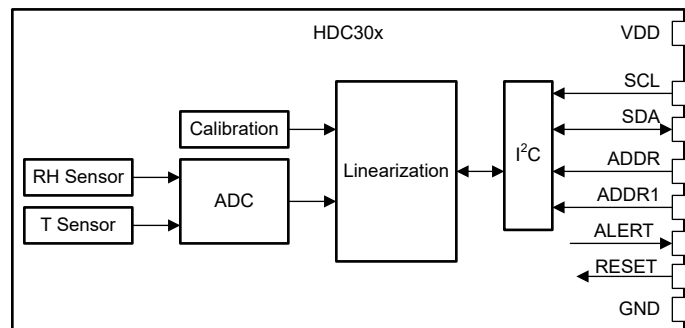

### 8.3 Feature Description

#### 8.3.1 Factory Installed Polyimide Tape

The HDC3021 has a polyimide tape to cover the opening of the humidity sensor element. The tape protects the humidity sensor element from pollutants that can be produced as part of the manufacturing process, such as SMT assembly, printed circuit board (PCB) wash, and conformal coating. The tape must be removed after the final stages of assembly for accurate measurement of relative humidity in the ambient environment. The tape can withstand at least three standard reflow cycles.

To remove the polyimide tape from the humidity sensor element, TI recommends to use a ESD-safe tweezer to grip the adhesive-free tab in the top right corner, and slowly peel the adhesive from the top-right corner towards the bottom-left corner in an upward direction (as opposed to across the surface). This will help to reduce the risk of scratching the humidity sensor element.

#### 8.3.2 Factory Installed IP67 Protection Cover

HDC3022 has an IP67 rated PTFE permanent filter to cover the opening of the humidity sensor element. The cover is a hydrophobic microporous PTFE foil that protects the humidity sensor element against dust, water and PCB wash according to IP67 specifications. The cover is designed to adhere to the package over lifetime operation while maintaining the same response time as a sensor without the membrane. The cover has a filtration efficiency of 99.99% down to a particle size of 100 nm.

### 8.3.3 Measurement of Relative Humidity and Temperature

The HDC302x supports measurements of Relative Humidity and Temperature. The supported Relative Humidity Range is 0% to 100% and the supported Temperature Range is from  $-40^{\circ}\text{C}$  to  $125^{\circ}\text{C}$ . Each measurement is represented in a 16-bit format, and the conversion formulas are documented below:

$$\text{RH}(\%) = 100 \times \left[ \frac{\text{RH}_{\text{HDC302x}}}{2^{16} - 1} \right] \quad (1)$$

$$\text{T}(^{\circ}\text{C}) = -45 + \left[ 175 \times \left( \frac{\text{T}_{\text{HDC302x}}}{2^{16} - 1} \right) \right] \quad (2)$$

$$\text{T}(^{\circ}\text{F}) = -49 + \left[ 315 \times \left( \frac{\text{T}_{\text{HDC302x}}}{2^{16} - 1} \right) \right] \quad (3)$$

### 8.3.4 Offset Error Correction: Accuracy Restoration

Due to contaminants, the natural aging of the sensor's polymer dielectric, and exposure to extreme operating conditions resulting in long-term drift, the HDC302x accuracy can incur an offset. Offset error correction can correct the offset. Offset error correction is self calibration of the offset error by a user-triggered firmware on the MCU through the usage of an integrated heater without the need of an accurate RH reference. This may remove the need for costly calibration by the end user or, when calibration is not possible, it can extend the end product high accuracy lifetime. More details and documentation for how to use the offset error correction feature are in the *HDC3x Silicon User's Guide* (SNAU265). And the HDC3020 EVM GUI allows customers to easily demo the offset error correction feature.

### 8.3.5 NIST Traceability of Relative Humidity and Temperature Sensor

The HDC302x units are 100% tested on a production setup that is NIST traceable and verified with equipment that is calibrated to ISO/IEC 17025 accredited standards. This permits design of the HDC302x into applications such as cold chain management, where the establishment of an unbroken chain of calibrations to known references is essential.

### 8.3.6 Measurement Modes: Trigger-On Demand vs Auto Measurement

Two types of measurement modes are available on the HDC302x: Trigger-on Demand and Auto Measurement mode.

Trigger-on Demand is a single measurement reading of temperature and relative humidity that is triggered through an I<sup>2</sup>C command on an as-needed basis. After the measurement is converted, the device remains in sleep mode until another I<sup>2</sup>C command is received.

Auto Measurement mode is a recurring measurement reading of temperature and relative humidity, eliminating the need to repeatedly initiate a measurement request through an I<sup>2</sup>C command. The measurement interval can be adjusted from 1 measurement every 2 seconds to 10 measurements every second. In Auto Measurement mode, the HDC302x wakes up from sleep to measurement mode based on the selected sampling rate.

Auto Measurement mode helps to reduce overall system power consumption in two ways. First, by removing the need to repeatedly initiate a measurement through an I<sup>2</sup>C command, sink current through the SCL and SDA pullup resistors is eliminated. Secondly, a microcontroller can be programmed into a deep sleep mode, and only woken up through an interrupt by the ALERT pin in the event of excessive temperature and relative humidity measurements.

### 8.3.7 Heater

The HDC302x includes an integrated heating element that can be switched on to prevent or remove any condensation that may develop when the ambient environment approaches its dew point temperature. Additionally, the heater can be used to verify functionally of the integrated temperature sensor.

If the dew point of an application is continuously calculated and tracked, and the application firmware is written such that it can detect a potential condensing situation (or a period of it), a software subroutine can be run, as a precautionary measure, to activate the onboard heater as an attempt to remove the condensate. The device

shall continue to measure and track the %RH level after the heater is activated. Once the %RH reading goes to zero % (or near it), the heater can be subsequently turned off to allow the device to cool down. Cooling of the device can take several minutes, but the temperature measurement will continue to run to ensure the device goes back to normal operating condition before restarting the device for normal service.

Note that when the heater activates, the operating temperature of the device shall be limited based on the *Recommended Operating Conditions*  $T_{\text{HEATER}}$  limits.

It is important to recognize that if using an open cavity sensor the integrated heater evaporates condensate that forms on top of the humidity sensor, but does not remove any dissolved contaminants. Any contaminant residue, if present, may impact the accuracy of the humidity sensor. Refer to [HDC3x Silicon User's Guide](#) for more details on condensation removal.

### 8.3.8 ALERT Output With Programmable Interrupts

Use the ALERT output pin to determine if the HDC302x records a measurement that indicates either the temperature and/or relative humidity result is outside of a programmed "comfort zone". The pin sends a hardware interrupt based on the programmable non-volatile thresholds for both temperature and humidity.

The ALERT output pin serves to drive circuit blocks where software monitoring is not feasible. Examples include enabling a power switch to start a dehumidifier, or to initiate a thermal shutdown. Additionally, the ALERT pin can minimize power drain by enabling a microcontroller to remain in deep sleep until environmental conditions require the microcontroller to wake up and perform debug and corrective actions.

### 8.3.9 Checksum Calculation

Error checking of data is supported with a Checksum Calculation. The 8-bit CRC checksum transmitted after each data word is generated by a CRC algorithm. [Table 8-1](#) shows the CRC properties. The CRC covers the contents of the two previously transmitted data bytes. To calculate the checksum, only these two previously transmitted data bytes are used.

A CRC byte is sent by the HDC302x to the I<sup>2</sup>C controller in the following cases:

1. Following the transmission of a relative humidity measurement
2. Following the transmission of a temperature measurement
3. Following the transmission of the contents of the [Table 8-12](#)
4. Following the transmission of any of the programmed ALERT limit values (High Alert, Set; High Alert, Clear; Low Alert, Set; Low Alert, Clear)

A CRC byte must be sent by the I<sup>2</sup>C controller to the HDC302x in the following cases:

1. Following the configuration of any of the ALERT limit values (High Alert, Set; High Alert, Clear; Low Alert, Set; Low Alert, Clear).
2. Following the configuring the heater.
3. Following writing offset into the part.

**Table 8-1. HDC302x CRC Properties**

PROPERTY	VALUE
Name	CRC-8/NRSC-5
Width	8 bit
Protected Data	Read and/or Write Data
Polynomial	$0x31 (x^8 + x^5 + x^4 + 1)$
Initialization	0xFF
Reflect Input	False
Reflect Output	False
Final XOR	0x00
Examples	CRC of 0xABCD = 0x6F

Retrieving the CRC byte from the HDC302x is optional. A NACK can be issued by the I<sup>2</sup>C controller prior to reception of the CRC byte to cancel, as shown in [Figure 8-1](#) and [Figure 8-2](#).

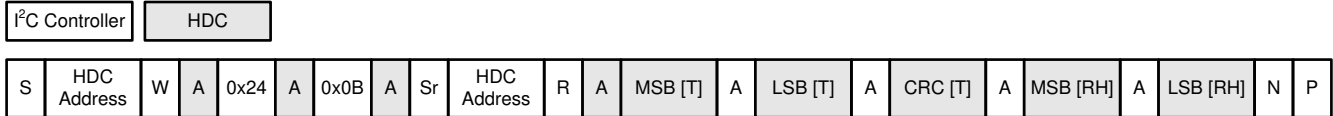

**Figure 8-1. Example I<sup>2</sup>C NACK to Discard CRC Byte Corresponding to Humidity Measurement Readout**

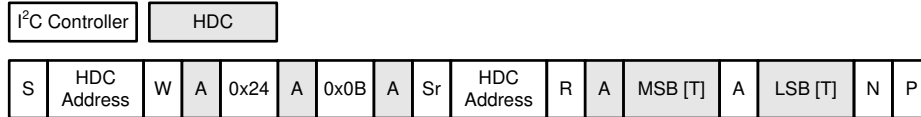

**Figure 8-2. Example I<sup>2</sup>C NACK to Discard CRC Byte Corresponding to Temperature Measurement Readout**

### 8.3.10 Programmable Offset of Relative Humidity and Temperature Results

HDC302x allows for the user to program a non-volatile offset value for relative humidity and temperature. The offset value can only be used to add or subtract from the sensor measurement results.

## 8.4 Device Functional Modes

The HDC302x has two modes of operation: Sleep Mode and Measurement Mode.

### 8.4.1 Sleep Mode vs Measurement Mode

Sleep mode is the default mode of the HDC302x upon Power Up/Cycle, Hard Reset through the  $\overline{\text{RESET}}$  pin, and Soft Reset. The HDC302x will wait for an I<sup>2</sup>C instruction to trigger a measurement, or to read and write valid data. A measurement request will trigger the HDC302x to switch to measurement mode, where measurements from the integrated sensors are passed through an internal ADC, and go through linearization using calibration data from within the device to produce accurate calculations of temperature and relative humidity. The results are stored in their respective data registers. After completing the conversion, the HDC302x returns to sleep mode.

## 8.5 Programming

### 8.5.1 I<sup>2</sup>C Interface

The HDC302x operates only as a target device on the I<sup>2</sup>C bus. Multiple devices on the same I<sup>2</sup>C bus with the same address are not allowed. Connection to the bus is made through the open-drain I/O lines, SCL and SDA. After power up, the sensor needs the sensor power-up ready time, Sensor<sub>PUR</sub>, before the sensor can begin the acquisition of temperature and relative humidity measurements. All data bytes are transmitted MSB first.

### 8.5.2 I<sup>2</sup>C Serial Bus Address Configuration

An I<sup>2</sup>C controller will communicate to a desired target device through a target address byte. The target address byte consists of seven address bits and a direction bit that indicates the intent to execute a read or write operation. The HDC302x features two address pins, which allow for supporting four addressable HDC302x devices on a single I<sup>2</sup>C bus. [Table 8-2](#) describes the pin logic levels used to communicate up to four devices. HDC302x pins ADDR and ADDR1 must be set before any activity on the interface.

**Table 8-2. HDC302x I<sup>2</sup>C Target Address**

ADDR	ADDR1	ADDRESS (Hex Representation)
Logic Low	Logic Low	0x44
Logic Low	Logic High	0x46
Logic High	Logic Low	0x45
Logic High	Logic High	0x47

### 8.5.3 I<sup>2</sup>C Write - Send Device Command

Communication to the HDC302x is based upon a command list, which is documented in [Table 8-3](#). Commands other than those documented are undefined and should not be sent to the device. An unsupported command

returns a NACK after the pointer, and a read or write operation with incorrect I<sup>2</sup>C address returns a NACK after the I<sup>2</sup>C address.

An I<sup>2</sup>C write sequence is performed to send a command to the HDC302x. Some of these commands also require configuration data from the I<sup>2</sup>C controller. In those instances, a CRC byte must accompany the configuration data to permit error checking by the HDC302x. Both of these I<sup>2</sup>C write scenarios are illustrated in [Figure 8-3](#) and [Figure 8-4](#).

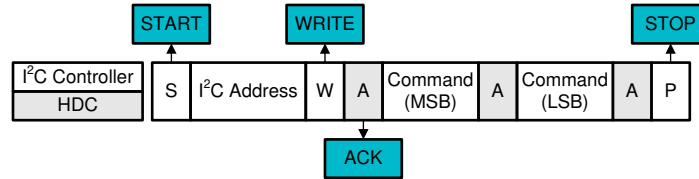

**Figure 8-3. I<sup>2</sup>C Write Command, No Configuration Data Required**

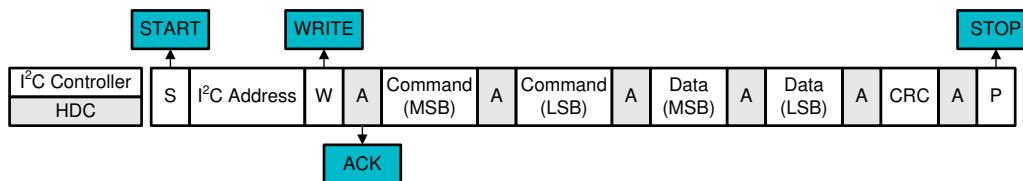

**Figure 8-4. I<sup>2</sup>C Write Command, Configuration Data and CRC Byte Required**

#### 8.5.4 I<sup>2</sup>C Read - Retrieve Single Data Result

An I<sup>2</sup>C read sequence is performed to retrieve data from the HDC302x. The I<sup>2</sup>C read sequence *must follow* the I<sup>2</sup>C write sequence that was used to initiate the data acquisition. A CRC byte always accompanies data that is transmitted by the HDC302x. If the I<sup>2</sup>C controller does not use the CRC byte to perform a data integrity check, then an I<sup>2</sup>C NACK can be issued to discard CRC transmission and save time. Both of these I<sup>2</sup>C read scenarios are illustrated in [Figure 8-5](#) and [Figure 8-6](#).

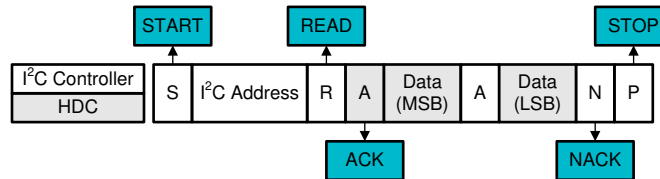

**Figure 8-5. I<sup>2</sup>C Read Single Data Result, CRC Discarded**

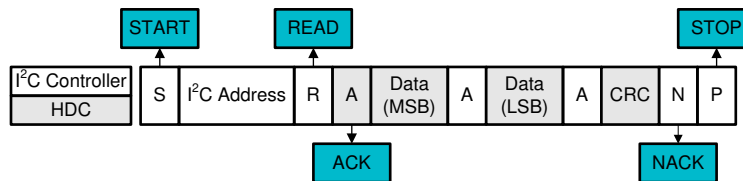

**Figure 8-6. I<sup>2</sup>C Read Single Data Result, CRC Retained**

The HDC302x will stop transmission of a data byte if the I<sup>2</sup>C controller fails to ACK after any byte of data.

#### 8.5.5 I<sup>2</sup>C Read - Retrieve Multi Data Result

When an I<sup>2</sup>C read sequence is performed to retrieve multiple data results and the I<sup>2</sup>C controller does not use the CRC byte to perform a data integrity check, then an I<sup>2</sup>C NACK can be issued to only discard CRC transmission from the final transmitted data result. Both of these I<sup>2</sup>C read scenarios are illustrated in [Figure 8-7](#) and [Figure 8-8](#).

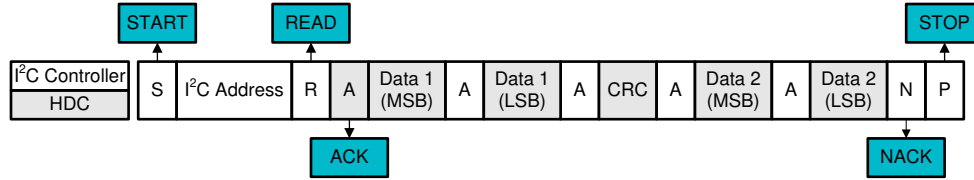

Figure 8-7. I<sup>2</sup>C Read Multi Data Result, Final CRC Discarded

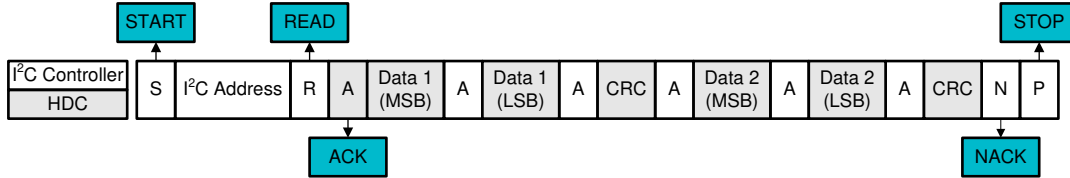

Figure 8-8. I<sup>2</sup>C Read Multi Data Result, Final CRC Retained

### 8.5.6 I<sup>2</sup>C Repeated START - Send Command and Retrieve Data Results

HDC302x supports I<sup>2</sup>C repeated START, which enables the issue of a command and retrieval of data without releasing the I<sup>2</sup>C bus. As with all other data retrieval requests, reception of the CRC byte corresponding to the last data result may be discarded or retained. Both of these examples are illustrated in Figure 8-9 and Figure 8-10 for a single data result retrieval, and in Figure 8-11 and Figure 8-12 for a multi data result retrieval.

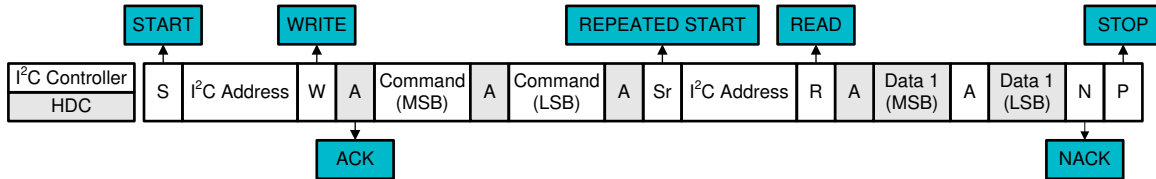

Figure 8-9. I<sup>2</sup>C Repeated START Sequence, Single Data Result, CRC Discarded

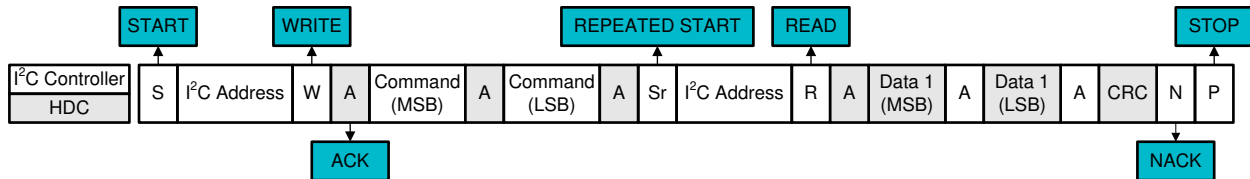

Figure 8-10. I<sup>2</sup>C Repeated START Sequence, Single Data Result, CRC Retained

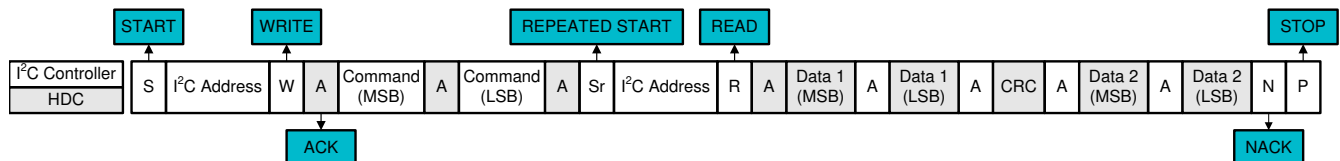

Figure 8-11. I<sup>2</sup>C Repeated START Sequence, Multi Data Result, Final CRC Discarded

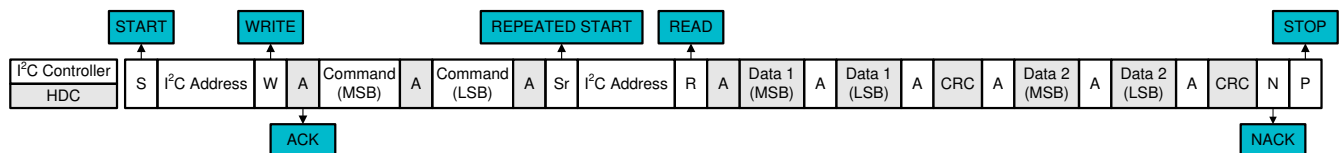

Figure 8-12. I<sup>2</sup>C Repeated START Sequence, Multi Data Result, Final CRC Retained

### 8.5.7 Command Table and Detailed Description

The HDC302x command structure is documented below in [Table 8-3](#). Details about each individual command are documented in the subsections below.

**Table 8-3. HDC302x Command Table**

HEX CODE (MSB)	HEX CODE (LSB)	COMMAND	COMMAND DETAIL
24	00		Low Power Mode 0 (lowest noise)
24	0B	Trigger-On Demand Mode	Low Power Mode 1
24	16	Single Temperature (T) Measurement	Low Power Mode 2
24	FF	Single Relative Humidity (RH) Measurement <sup>(1)</sup>	Low Power Mode 3 (lowest power)
20	32		Low Power Mode 0 (lowest noise)
20	24	Auto Measurement Mode	Low Power Mode 1
20	2F	1 measurement per 2 seconds.	Low Power Mode 2
20	FF		Low Power Mode 3 (lowest power)
21	30		Low Power Mode 0 (lowest noise)
21	26	Auto Measurement Mode	Low Power Mode 1
21	2D	1 measurement per second.	Low Power Mode 2
21	FF		Low Power Mode 3 (lowest power)
22	36		Low Power Mode 0 (lowest noise)
22	20	Auto Measurement Mode	Low Power Mode 1
22	2B	2 measurements per second.	Low Power Mode 2
22	FF		Low Power Mode 3 (lowest power)
23	34		Low Power Mode 0 (lowest noise)
23	22	Auto Measurement Mode	Low Power Mode 1
23	29	4 measurements per second.	Low Power Mode 2
23	FF		Low Power Mode 3 (lowest power)
27	37		Low Power Mode 0 (lowest noise)
27	21	Auto Measurement Mode	Low Power Mode 1
27	2A	10 measurements per second.	Low Power Mode 2
27	FF		Low Power Mode 3 (lowest power)
2C	06	Trigger-On Demand Mode	Low Power Mode 0 (lowest noise)
2C	0D	Single Temperature (T) Measurement	Low Power Mode 1
2C	10	Single Relative Humidity (RH) Measurement <sup>(1)</sup>	Low Power Mode 2
30	93		Exit, then return to Trigger-on Demand Mode.
E0	00		Measurement Readout of T and RH.
E0	02	Auto Measurement Mode	Measurement History Readout of Minimum T.
E0	03		Measurement History Readout of Maximum T.
E0	04		Measurement History Readout of Minimum RH.
E0	05		Measurement History Readout of Maximum RH.
61	00		Programs Thresholds for "Set Low Alert"
61	1D		Programs Thresholds for "Set High Alert"
61	0B	Configure ALERT Thresholds of T and RH	Programs Thresholds for "Clear Low Alert"
61	16		Programs Thresholds for "Clear High Alert"
61	55		Transfer ALERT thresholds into Non-Volatile Memory (NVM)

**Table 8-3. HDC302x Command Table (continued)**

HEX CODE (MSB)	HEX CODE (LSB)	COMMAND	COMMAND DETAIL
E1	02	Verify ALERT Thresholds of T and RH	Read Thresholds for "Set Low Alert"
E1	1F		Read Thresholds for "Set High Alert"
E1	09		Read Thresholds for "Clear Low Alert"
E1	14		Read Thresholds for "Clear High Alert"
30	6D	Integrated Heater	Enable
30	66		Disable
30	6E	Integrated Heater	Configure
F3	2D	Status Register	Read Content
30	41		Clear Content
A0	04	Program/Read Offset Value of Relative Humidity and Temperature Results into/from non-volatile memory	
30	A2	Soft Reset	
36	83	Read NIST ID (Serial Number) Bytes 5 and 4	
36	84	Read NIST ID (Serial Number) Bytes 3 and 2	
36	85	Read NIST ID (Serial Number) Bytes 1 and 0	
37	81	Read Manufacturer ID (Texas Instruments) (0x3000)	
61	BB	Override Default Device Power-On/Reset Measurement State	

- (1) For Trigger on Demand Mode there are three pairs of commands where either command in the pair gives the same results:
- 0x2400 and 0x2C06
  - 0x240B and 0x2C0D
  - 0x2416 and 0x2C10

**Table 8-4. List of Valid Configuration Values to Override the Default Device Power-On/Reset Measurement State HDC302x**

CFG (MSB)	CRC (LSB)	Configuration	Low Power Mode	Measurements per Second
0x03	0xB0	Automatic Measurement Mode	0 (lowest noise)	0.5
0x05	0xD2	Automatic Measurement Mode	0 (lowest noise)	1
0x07	0x74	Automatic Measurement Mode	0 (lowest noise)	2
0x09	0x16	Automatic Measurement Mode	0 (lowest noise)	4
0x0B	0x09	Automatic Measurement Mode	0 (lowest noise)	10
0x13	0xF3	Automatic Measurement Mode	1	0.5
0x15	0x91	Automatic Measurement Mode	1	1
0x17	0x37	Automatic Measurement Mode	1	2
0x19	0x55	Automatic Measurement Mode	1	4
0x1B	0x4A	Automatic Measurement Mode	1	10
0x23	0x36	Automatic Measurement Mode	2	0.5
0x25	0x54	Automatic Measurement Mode	2	1
0x27	0xF2	Automatic Measurement Mode	2	2
0x29	0x90	Automatic Measurement Mode	2	4
0x2B	0x8F	Automatic Measurement Mode	2	10
0x33	0x75	Automatic Measurement Mode	3 (lowest power)	0.5
0x35	0x17	Automatic Measurement Mode	3 (lowest power)	1
0x37	0xB1	Automatic Measurement Mode	3 (lowest power)	2
0x39	0xD3	Automatic Measurement Mode	3 (lowest power)	4
0x3B	0xCC	Automatic Measurement Mode	3 (lowest power)	10

**Table 8-4. List of Valid Configuration Values to Override the Default Device Power-On/Reset Measurement State HDC302x (continued)**

CFG (MSB)	CRC (LSB)	Configuration	Low Power Mode	Measurements per Second
0x00	0x81	Restores Factory Default (Sleep Mode)	N/A	N/A

### 8.5.7.1 Reset

#### 8.5.7.1.1 Soft Reset

The HDC302x provides a software command, as illustrated in Figure 8-13, to force itself into its default state while maintaining supply voltage. It is the software equivalent to a hardware reset through the Power Cycle or toggle of the RESET pin. When executed, the HDC302x will reset its Status Register, reload the calibration data and programmed humidity/temperature offset error from memory, clear previously stored measurement results, set Interrupt Thresholds limits back to their defaults, and re-configure the ALERT output to its default condition.

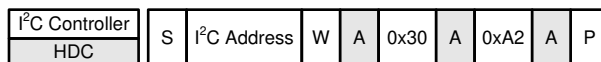

**Figure 8-13. I<sup>2</sup>C Command Sequence: HDC302x Software Reset**

#### 8.5.7.1.2 I<sup>2</sup>C General Call Reset

In addition to the device-specific Soft Reset command, the HDC302x supports the general call address of the I<sup>2</sup>C specification. This enables the use of a single command to reset an entire I<sup>2</sup>C system (provided that all devices on the I<sup>2</sup>C bus support it). Figure 8-14 shows this command. The general call is recognized when the sensor is able to process I<sup>2</sup>C commands and is functionally equivalent to the Software Reset.

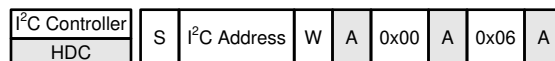
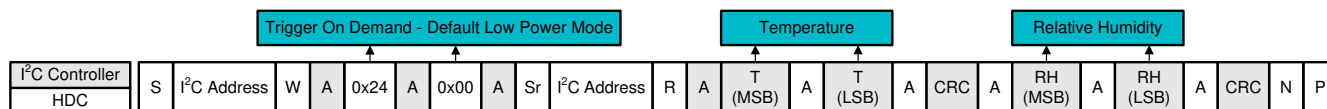

**Figure 8-14. I<sup>2</sup>C Command Sequence: HDC302x Reset Through General Call**

### 8.5.7.2 Trigger-On Demand

This set of commands will trigger a single measurement acquisition of temperature, followed by relative humidity. The HDC302x will transition from sleep mode into measurement mode, and upon measurement completion, return to sleep mode. There are four possible Trigger On Demand commands, each one corresponding to a different low power mode (and therefore, different levels of power consumption). Table 8-3 shows these commands.

The measurement readout from these commands is obtained through an I<sup>2</sup>C read sequence, as previously documented in *I<sup>2</sup>C Read - Retrieve Single Data Result* and *I<sup>2</sup>C Read - Retrieve Multi Data Result*. The format of the measurement readout is two bytes of data representing temperature, followed by one byte CRC checksum, and then another two bytes of data representing relative humidity, followed by one byte CRC checksum as illustrated in Figure 8-15.



**Figure 8-15. I<sup>2</sup>C Command Sequence: Example Measurement Readout in Trigger-On Demand Mode**

If the I<sup>2</sup>C controller attempts to read the measurements results prior to measurement completion, the HDC302x will respond with a NACK condition, as illustrated in Figure 8-16.

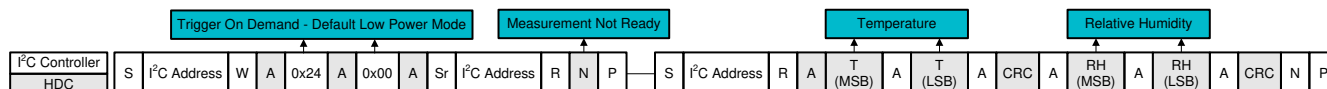

**Figure 8-16. I<sup>2</sup>C Command Sequence: Example Measurement Not Ready in Trigger-On Demand Mode**

### 8.5.7.3 Auto Measurement Mode

Auto Measurement mode forces the HDC302x to perform a temperature and relative humidity measurement at a specific timing interval, removing the need for the I<sup>2</sup>C controller to repeatedly initiate a measurement acquisition. This section gives additional details for each command

#### 8.5.7.3.1 Auto Measurement Mode: Enable and Configure Measurement Interval

There are 20 possible timing intervals when Auto Measurement mode is enabled, (and therefore, different levels of average power consumption). These commands are documented in Table 8-3. To avoid self-heating of the temperature sensor, TI recommends to limit the sampling interval to no faster than 1 measurement/second, as illustrated in Figure 8-17.

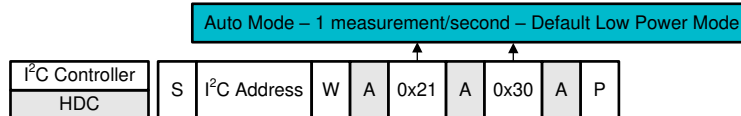

Figure 8-17. I<sup>2</sup>C Command Sequence: Enable Auto Measurement Mode at 1 Measurement per Second

#### 8.5.7.3.2 Auto Measurement Mode: Measurement Readout

The latest measurement acquisition in Auto Measurement Mode can be retrieved using a measurement readout command, which is documented in Table 8-3, and illustrated in Figure 8-18. Once the measurement readout is complete, the HDC302x clears the measurement result from memory.

As in *Trigger-On Demand*, if the I<sup>2</sup>C controller attempts to read the measurement results prior to measurement completion, the HDC302x will respond with a NACK condition.

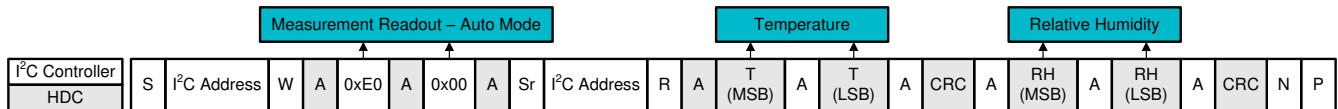

Figure 8-18. I<sup>2</sup>C Command Sequence: Measurement Readout in Auto Measurement Mode

#### 8.5.7.3.3 Auto Measurement Mode: Exit

The command to exit Auto Measurement mode is documented in Table 8-3 and illustrated in Figure 8-19. The HDC302x will immediately discontinue any measurement in progress and return to sleep mode. This takes typically 1 ms.

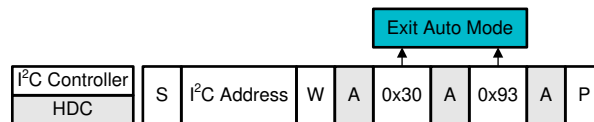

Figure 8-19. I<sup>2</sup>C Command Sequence: Exit Auto Measurement Mode

#### 8.5.7.3.4 Auto Measurement Mode: Measurement History Readout

Within Auto Measurement Mode, the HDC302x maintains a history of the maximum and minimum measurement for temperature and relative humidity (described as variables MIN T, MAX T, MIN RH, and MAX RH). This feature is useful for scenarios where the user would like to assess if the ambient conditions ever approached, but did not surpass, the defined environmental thresholds as documented in *ALERT Output: Environmental Tracking of Temperature and Relative Humidity*. Table 8-5 summarizes the status of MIN T, MAX T, MIN RH, and MAX RH based on device configuration.

Table 8-5. Status of Measurement History Variables Based on HDC302x Configuration

HDC302x Configuration	MIN T	MAX T	MIN RH	MAX RH
Outside of Auto Measurement Mode	130°C	-45°C	100%	0%
Within Auto Measurement Mode	Monitored and Latched When Appropriate			

Whenever the HDC302x exits Auto Measurement Mode (for example, through Auto Measurement Mode: Exit, Soft Reset, General Call Reset), all four variables will return to their default values documented in Table 8-5. Therefore, measurement history readouts outside of Auto Measurement Mode are invalid. Figure 8-20, Figure 8-21, Figure 8-22, and Figure 8-23 illustrate the I<sup>2</sup>C sequence for measurement readout of MIN T, MAX T, MIN RH, and MAX RH.

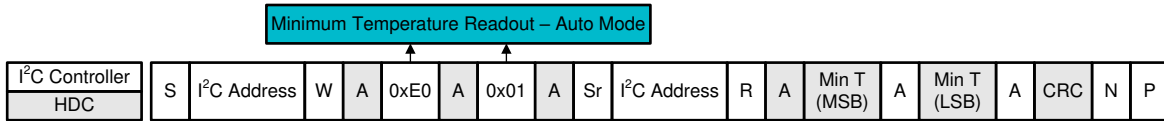

Figure 8-20. I<sup>2</sup>C Sequence: Minimum Temperature Measurement Readout (Auto Measurement Mode)

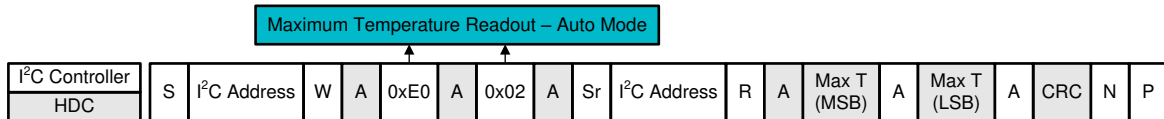

Figure 8-21. I<sup>2</sup>C Sequence: Maximum Temperature Measurement Readout (Auto Measurement Mode)

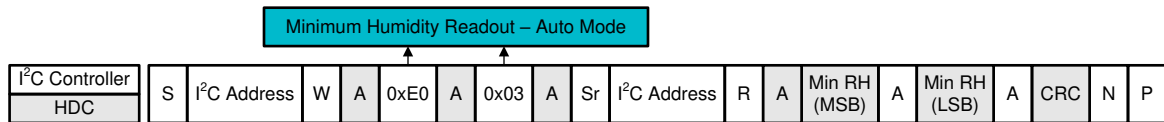

Figure 8-22. I<sup>2</sup>C Sequence: Minimum Relative Humidity Measurement Readout (Auto Measurement Mode)

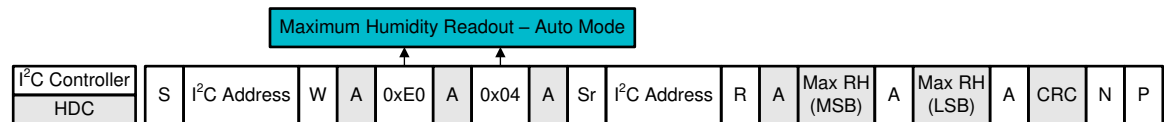

Figure 8-23. I<sup>2</sup>C Sequence: Maximum Relative Humidity Measurement Readout (Auto Measurement Mode)

#### 8.5.7.3.5 Override Default Device Power-On and Device-Reset State

The HDC302x defaults to entering sleep mode after a device power-on or a device-reset. However, an override command may be sent to the HDC302x to force entry into Automatic Measurement mode upon every device power-on and device-reset. The command is illustrated in below in Figure 8-24 and the list of all possible command configurations is documented in Table 8-4.

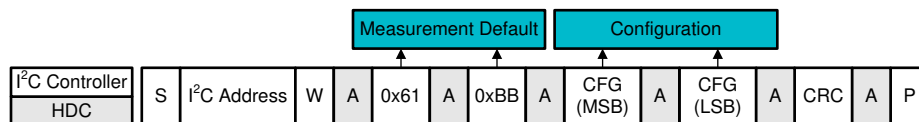

Figure 8-24. I<sup>2</sup>C Sequence: Configure Default Measurement

### 8.5.7.4 ALERT Output Configuration

The HDC302x provides hardware notification of events through an interrupt output pin (ALERT). Specifically, the ALERT output represents the status of bits 15, 11, 10, and 4 from the [Status Register](#). The ALERT output asserts to Logic High upon detection of an event and de-asserts to Logic Low when the event has passed or after the [Status Register](#) is cleared.

The ALERT output is activated by default upon Power Up, Hardware Reset, and Soft Reset. It is deactivated when the HDC302x has been disabled via assertion of the  $\overline{\text{RESET}}$  pin. When deactivated, the HDC302x will clear the [Status Register](#).

If temperature and relative humidity tracking through the ALERT output is not desired, the feature can be disabled as explained in [ALERT Output: Deactivation of Environmental Tracking](#).

#### 8.5.7.4.1 ALERT Output: Environmental Tracking of Temperature and Relative Humidity

The primary use of the ALERT output is to provide a hardware notification of ambient temperature and relative humidity measurements that violate programmed thresholds. There are a total of four programmable thresholds for temperature and relative humidity, as documented in [Table 8-3](#) and illustrated in [Figure 8-25](#) below.

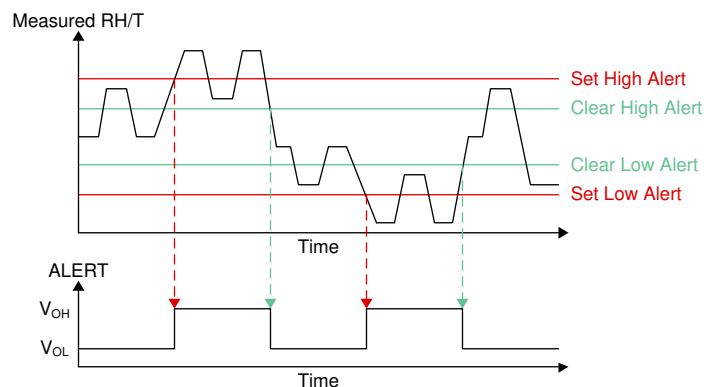

**Figure 8-25. Graphical Illustration of ALERT Programmable Environmental Thresholds**

The four programmable thresholds are listed below

1. **Set High Alert:** Asserts ALERT output when HDC302x measures a temperature or relative humidity level that has risen above this value.
2. **Clear High Alert:** Deasserts the ALERT output caused by [Set High Alert](#), once HDC302x measures a temperature or relative humidity level that has fallen below this value.
3. **Set Low Alert:** Programmed value that asserts ALERT output when HDC302x measures a temperature or relative humidity level that has fallen below this value.
4. **Clear Low Alert:** Programmed value that deasserts the ALERT output caused by [Set Low Alert](#), once HDC302x measures a temperature of relative humidity level that has risen above this value.

If the user application utilizes the ALERT output for environmental tracking, it is best practice to program these four thresholds prior to any temperature or relative humidity measurement acquisition. Programming enough separation between the Set versus Clear thresholds will prevent fast oscillations of the ALERT output.

These programmed limits are accessible at any time of operation .

### 8.5.7.4.2 ALERT Output: Representation of Environmental Thresholds and Default Threshold Values

The [Set High Alert](#), [Clear High Alert](#), [Set Low Alert](#), and [Clear Low Alert](#) thresholds are each represented by a truncated 16 bit value, as illustrated [Figure 8-26](#). The 7 MSBs from a relative humidity measurement are concatenated with the 9 MSBs from a temperature measurement. The actual temperature and relative humidity measurement result are always stored as a 16-bit value, but when compared against the programmed threshold values, due to the truncated representation, there is a resolution loss of 0.5°C in temperature and a 1% resolution loss in relative humidity.

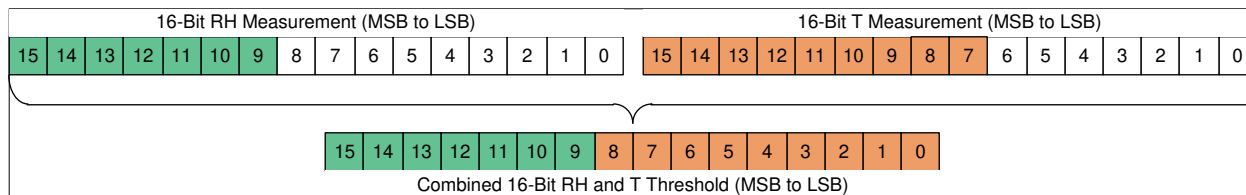

**Figure 8-26. Representation of ALERT Threshold Value Using Combined RH and T**

The default values of the relative humidity and temperature thresholds after Power Up/Cycle, Hardware Reset, and Soft Reset are documented in [Table 8-6](#) below. Refer to [Table 8-3](#) for the appropriate command to re-program the thresholds.

**Table 8-6. Default Value of ALERT Thresholds**

ALERT THRESHOLD	DEFAULT RH THRESHOLD	DEFAULT T THRESHOLD	HEX VALUE	CRC
<a href="#">Set High Alert</a>	80% RH	60°C	0xCD33	0xFD
<a href="#">Clear High Alert</a>	79% RH	58°C	0xC92D	0x22
<a href="#">Set Low Alert</a>	20% RH	-10°C	0x3466	0xAD
<a href="#">Clear Low Alert</a>	22% RH	-9°C	0x3869	0x37

### 8.5.7.4.3 ALERT Output: Steps to Calculate and Program Environmental Thresholds

The steps to calculate the [Set High Alert](#), [Clear High Alert](#), [Set Low Alert](#), and [Clear Low Alert](#) thresholds are listed below:

1. Select the desired relative humidity and temperature threshold to program, and the programmed value.
2. Convert the relative humidity and temperature threshold value to its respective 16-bit binary value
3. Retain the 7 MSBs for relative humidity and the 9 MSBs for temperature
4. Concatenate the 7 MSBs for relative humidity with the 9 MSBs for temperature to complete the 16-bit threshold representation
5. Calculate the CRC byte from the 16-bit threshold value

An example is provided below.

1. In this case, the [Set High Alert](#) threshold will be programmed to 90% RH and 65°C
2. 90% RH converts to 0b1110011001100111 and 65°C T converts to 0b1010000011101011
3. 7 MSBs for 90% RH is 0b1110011 and 9 MSBs for 65°C T is 0b101000001
4. After concatenation of the relative humidity and temperature MSBs, the threshold representation is 0b111001101000001 = 0xE741
5. For 0xE741, this corresponds to a CRC byte 0x55
  - a. [Figure 8-27](#) illustrates the appropriate command to send to the HDC302x.
  - b. The HDC302x will respond to reception of an incorrect CRC byte with a I<sup>2</sup>C NACK.

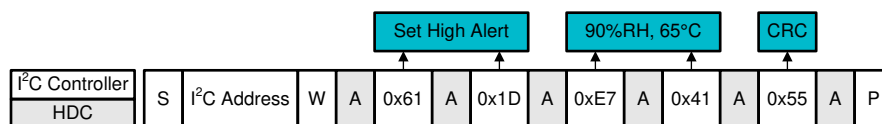
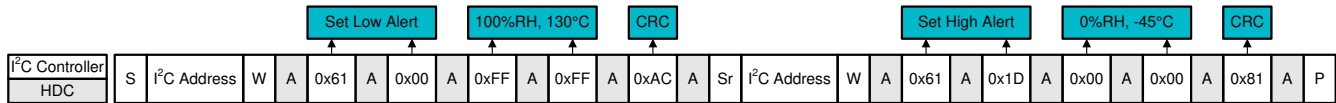

**Figure 8-27. I<sup>2</sup>C Command Sequence: Example Programming of Set High Alert to 90% RH, 65°C**

#### 8.5.7.4.4 ALERT Output: Deactivation of Environmental Tracking

To deactivate the ALERT output from responding to measurement results of temperature and/or relative humidity, the **Set High Alert** thresholds must be programmed to be lower than the **Set Low Alert** thresholds. **Figure 8-28** illustrates an example of threshold programming that disables tracking of temperature as well as relative humidity. To be more specific:

- To disable Temperature Alert Tracking: Configure the temperature bits within the **Set Low Alert** threshold to be larger than the temperature bits within the **Set High Alert** threshold.
- To disable Humidity Alert Tracking: Configure the humidity bits within the **Set Low Alert** threshold to be larger than the humidity bits within the **Set High Alert** threshold.



**Figure 8-28. I<sup>2</sup>C Command Sequence: Example to Deactivate ALERT Output Tracking of Temperature and Relative Humidity**

#### 8.5.7.4.5 ALERT Output: Transfer Thresholds into Non-Volatile Memory

This command, illustrated below in **Figure 8-29**, enables an override of the default ALERT threshold values after a device reset or power cycle. This permits independent assembly of a sensor board and a remote MCU board. Normally, the MCU is local to the sensor (that is, they share a common board) and the MCU will program the threshold values. However, there are applications where the sensor and MCU are on separate boards, and deployed to various applications, each with unique threshold requirements. This normally adds significant tracking overhead (that is, each MCU board must be assigned to a specific sensor board). With this feature, the HDC302x thresholds may be configured using a debugger/programmer during product assembly, and later on, connected to any MCU board on its own assembly, with the application-specific thresholds already ensured.

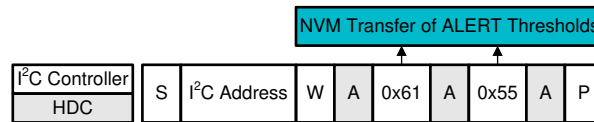

**Figure 8-29. I<sup>2</sup>C Command Sequence: Transfer ALERT Thresholds into NVM**

### 8.5.7.5 Programmable Measurement Offset

The HDC302x can be programmed to return a relative humidity measurement and/or a temperature measurement that accounts for a programmed offset value. An operation bit determines whether to add or subtract the offset from the actual sensor measurement results. This feature is targeted for designs where local heat sources can not be isolated from the temperature sensor and said heat sources show variation over time (due to different components being enabled/disabled). The command is documented in the [Table 8-3](#).

The device should be in shutdown mode if the user wants to change the offset because the device could give unpredictable results if the device is in Auto Measurement Mode. Note the RH measurement uses the measured temperature for correction and does not use the programmed temperature offset, which allows the user to program a temperature offset to account for local heating without affecting RH accuracy.

Programming either offset value requires programming of a corresponding non-volatile memory location in the EEPROM. Therefore, I<sup>2</sup>C writes are not permitted until offset programming is complete. Refer to the [Electrical Characteristics Table](#) for the time needed to complete programming a single location,  $t_{\text{PROG}}$ , and the current required during programming,  $I_{\text{EEPROM}}$ .

#### 8.5.7.5.1 Representation of Offset Value and Factory Shipped Default Value

As illustrated in [Figure 8-30](#), the programmed offset values for relative humidity ( $RH_{\text{OS}}$ ) and temperature ( $T_{\text{OS}}$ ) are combined into a single 16-bit representation. 7 bits represent  $RH_{\text{OS}}$ , 7 bits represent  $T_{\text{OS}}$ , 1 operation bit ( $RH_{+/-}$ ) to add or subtract  $RH_{\text{OS}}$ , and 1 operation bit ( $T_{+/-}$ ) to add or subtract  $T_{\text{OS}}$ . From the 16-bit representation of relative humidity, bits 13 through 7 are used to represent  $RH_{\text{OS}}$ . From the 16-bit representation of temperature, bits 12 through 6 are used to represent  $T_{\text{OS}}$ .

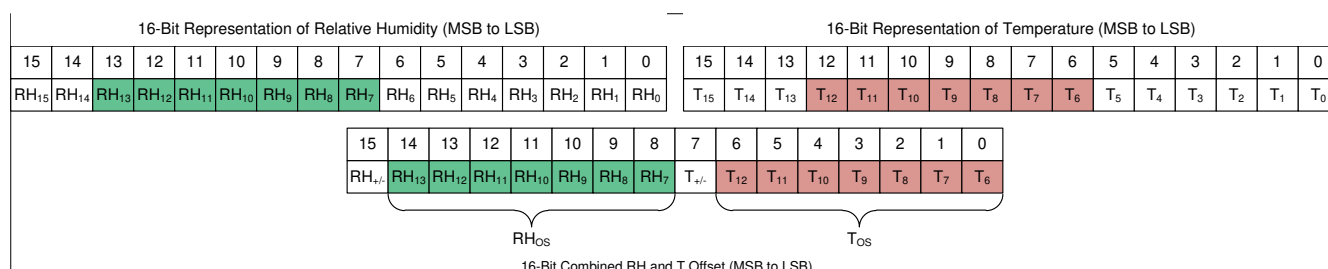

**Figure 8-30. Data Structure to Represent Programmed Offset Values for RH and T**

#### 8.5.7.5.2 Factory Shipped Default Offset Values

The HDC302x is factory-shipped with default values of  $RH_{\text{OS}}$  and  $T_{\text{OS}}$  as documented in [Table 8-7](#).

**Table 8-7. Factory Shipped Default Offset Value**

DEFAULT $RH_{\text{OS}}$ [%]	DEFAULT $T_{\text{OS}}$ [°C]	HEX VALUE (0x)	CRC (0x)
0	0	00 00	81

#### 8.5.7.5.3 Calculate Relative Humidity Offset Value

[Table 8-8](#) documents the programmed offset value that is represented by each individual relative humidity offset bit within  $RH_{\text{OS}}$ . The minimum programmable offset is 0.1953125% and the maximum programmable offset is 24.8046875%.

**Table 8-8. Relative Humidity Offset Value ( $RH_{\text{OS}}$ ) Represented by Each Data Bit**

RH OFFSET BIT	VALUE WHEN PROGRAMMED TO 0	VALUE WHEN PROGRAMMED TO 1
RH <sub>+/-</sub>	Subtract	Add
RH <sub>13</sub>	0	12.5
RH <sub>12</sub>	0	6.25
RH <sub>11</sub>	0	3.125
RH <sub>10</sub>	0	1.5625
RH <sub>9</sub>	0	0.78125

**Table 8-8. Relative Humidity Offset Value (RH<sub>OS</sub>) Represented by Each Data Bit (continued)**

RH OFFSET BIT	VALUE WHEN PROGRAMMED TO 0	VALUE WHEN PROGRAMMED TO 1
RH <sub>8</sub>	0	0.390625
RH <sub>7</sub>	0	0.1953125

Table 8-9 below gives an example of some of the possible calculated relative humidity offset values (including the operation bit RH<sub>+/-</sub>):

**Table 8-9. Example Programmed Values of RH<sub>OS</sub>**

RH <sub>+/-</sub>	RH <sub>13</sub>	RH <sub>12</sub>	RH <sub>11</sub>	RH <sub>10</sub>	RH <sub>9</sub>	RH <sub>8</sub>	RH <sub>7</sub>	RH OFFSET VALUE
1	0	0	0	0	0	0	1	+0.1952125% RH
0	0	0	0	0	0	0	1	-0.1952125% RH
1	1	0	0	0	0	0	0	+12.5% RH
0	1	0	0	0	0	0	0	-12.5% RH
1	0	1	0	1	0	1	0	+8.203125% RH
0	0	1	0	1	0	1	0	-8.203125% RH
1	1	1	1	1	1	1	1	+24.8046875% RH
0	1	1	1	1	1	1	1	-24.8046875% RH

#### 8.5.7.5.4 Calculate Temperature Offset Value

Table 8-10 documents the programmed offset value that is represented by each individual relative temperature offset bit within T<sub>OS</sub>. The minimum programmable offset is 0.1708984375°C and the maximum programmable offset is 21.7041015625°C.

**Table 8-10. Temperature Offset Value (T<sub>OS</sub>) Represented by Each Data Bit**

T OFFSET BIT	VALUE WHEN PROGRAMMED TO 0	VALUE WHEN PROGRAMMED TO 1
T <sub>+/-</sub>	Subtract	Add
T <sub>12</sub>	0	10.9375
T <sub>11</sub>	0	5.46875
T <sub>10</sub>	0	2.734375
T <sub>9</sub>	0	1.3671875
T <sub>8</sub>	0	0.68359375
T <sub>7</sub>	0	0.341796875
T <sub>6</sub>	0	0.1708984375

Table 8-11 below gives an example of some of the possible calculated temperature offset values (including the operation bit T<sub>+/-</sub>):

**Table 8-11. Example Programmed Values of T<sub>OS</sub>**

T <sub>+/-</sub>	T <sub>12</sub>	T <sub>11</sub>	T <sub>10</sub>	T <sub>9</sub>	T <sub>8</sub>	T <sub>7</sub>	T <sub>6</sub>	T OFFSET VALUE
1	0	0	0	0	0	0	1	+0.1708984375°C
0	0	0	0	0	0	0	1	-0.1708984375°C
1	1	0	0	0	0	0	0	+10.9375°C
0	1	0	0	0	0	0	0	-10.9375°C
1	0	1	0	1	0	1	0	+7.17734375°C
0	0	1	0	1	0	1	0	-7.17734375°C
1	1	1	1	1	1	1	1	21.7041015625°C
0	1	1	1	1	1	1	1	-21.7041015625°C

### 8.5.7.5.5 Write an Offset Value

After determining the desired value of  $RH_{+/-}$ ,  $RH_{OS}$ ,  $T_{+/-}$ , and  $T_{OS}$ , as documented in [Calculate Relative Humidity Offset Value](#) and [Calculate Temperature Offset Value](#), determine the correct CRC checksum and send all three bytes to the HDC302x as illustrated in [Figure 8-31](#) (along with an example scenario of +8.20% RH and  $-7.17^{\circ}C$ ).

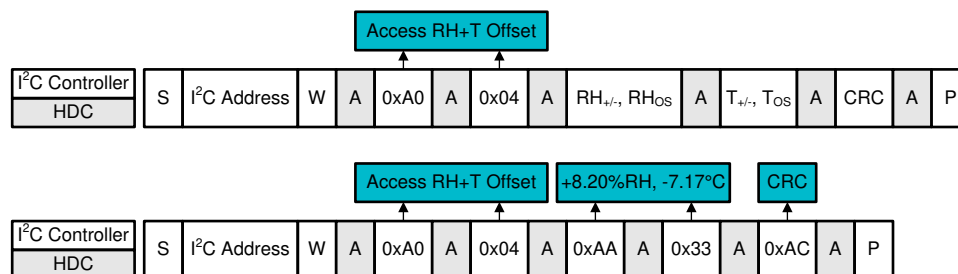

**Figure 8-31. I<sup>2</sup>C Command Sequence: RH and T Offset (Example With +8.20% RH and  $-7.17^{\circ}C$ )**

### 8.5.7.5.6 Verify a Programmed Offset Value

The command to verify the programmed offset values is documented in [Table 8-3](#) and the command sequence is illustrated in [Figure 8-32](#).

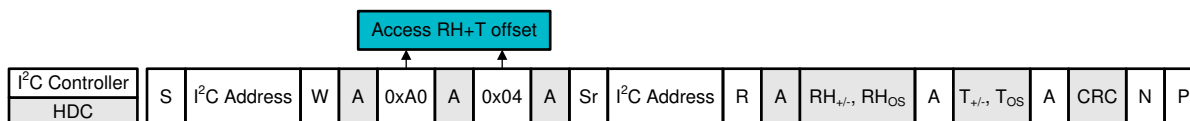

**Figure 8-32. I<sup>2</sup>C Command Sequence: Verify Programmed RH and T Offset**

### 8.5.7.6 Status Register

The Status Register contains real-time information about the operating state of the HDC302x, as documented in [Table 8-12](#). There are two commands associated with the Status Register: Read Content and Clear Content, as documented in [Table 8-3](#) and illustrated in [Figure 8-33](#) and [Figure 8-34](#).

**Table 8-12. Customer View: Status Register**

BIT	DEFAULT	DESCRIPTION
15	1	Overall Alert Status 0 = No active alerts 1 = At least one active alert
14	0	Reserved
13	0	Heater Status 0 = Heater Disabled 1 = Heater Enabled
12	0	Reserved
11	0	RH Tracking Alert 0 = No RH alert 1 = RH alert
10	0	T Tracking Alert 0 = No T alert 1 = T alert
9	0	RH High Tracking Alert 0 = No RH High alert 1 = RH High alert
8	0	RH Low Tracking Alert 0 = No RH Low alert 1 = RH Low alert
7	0	T High Tracking Alert 0 = No T High alert 1 = T High alert

**Table 8-12. Customer View: Status Register (continued)**

BIT	DEFAULT	DESCRIPTION
6	0	T Low Tracking Alert 0 = No T Low alert 1 = T Low alert
5	0	Reserved
4	1	Device Reset Detected 0 = No reset detected since last clearing of Status Register 1 = Device reset detected (via hard reset, soft reset command or supply fail)
3	0	Reserved
2	0	Reserved
1	0	Reserved
0	0	Checksum verification of last data write 0 = Pass (correct checksum received) 1 = Fail (incorrect checksum received)

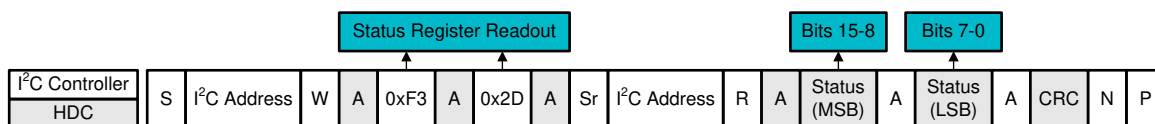

**Figure 8-33. I<sup>2</sup>C Command Sequence: Read Status Register**

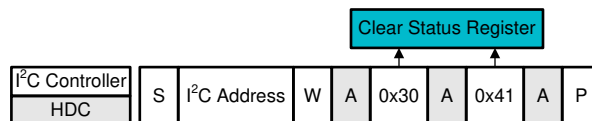

**Figure 8-34. I<sup>2</sup>C Command Sequence: Clear Status Register**

**8.5.7.7 Heater: Enable and Disable**

The HDC302x includes an integrated heater with enough power to enable operation in condensing environments. The heater protects the humidity sensor area by preventing condensation as well as removing condensate. Enabling and disabling of the heater is documented in [Table 8-3](#) and illustrated in [Figure 8-35](#) and [Figure 8-36](#).

The heater is expected to impact the temperature measurement result and the relative humidity measurement result. An IC-based humidity sensor uses the die temperature as an estimate for the ambient temperature. Use of the heater will increase the die temperature up to 60°C above ambient temperature. Therefore, accurate measurement results of ambient temperature and relative humidity are not possible when the heater is in operation.

It is important to recognize that the integrated heater will evaporate condensate that forms on top of the humidity sensor, but does not remove any dissolved contaminants. This contaminant residue, if present, may impact the accuracy of the humidity sensor. The IP67 rated PTFE permanent filter of HDC3022 protects the humidity sensor from the condensation and the dissolved contaminants when the condensation is evaporated.

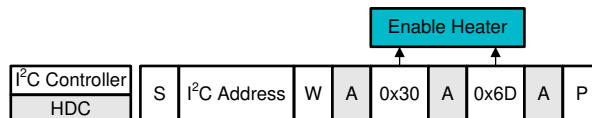

**Figure 8-35. I<sup>2</sup>C Command Sequence: Enable Heater**

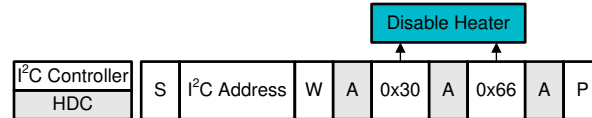

**Figure 8-36. I<sup>2</sup>C Command Sequence: Disable Heater**

### 8.5.7.8 Heater: Configure Level of Heater Current

The HDC302x heater architecture is comprised of 14 resistors in parallel, allowing support of several different power levels. The intent of this resistor array is to configure the appropriate heater current for offset error correction or condensation prevention/removal based on the ambient temperature and supply voltage. The heater array is represented by HEATER\_CONFIG[15:0], which is defined as:

HEATER\_CONFIG[15:0] = 0b00H<sub>13</sub>H<sub>12</sub>H<sub>11</sub>H<sub>10</sub>H<sub>9</sub>H<sub>8</sub>H<sub>7</sub>H<sub>6</sub>H<sub>5</sub>H<sub>4</sub>H<sub>3</sub>H<sub>2</sub>H<sub>1</sub>H<sub>0</sub>, where each H<sub>X</sub> bit represents the configuration of Heater #X of 14. The table below provides a partial list of heater configuration options.

**Table 8-13. Example Configurations of HEATER\_CONFIG[16:0]**

DESIRED HEATER CONFIGURATION	REQUIRED HEATER_CONFIG[15:0][HEX]	CRC
ENABLE HEATER full power	3F FF	06
ENABLE HEATER half power	03 FF	00
ENABLE HEATER quarter power	00 9F	96

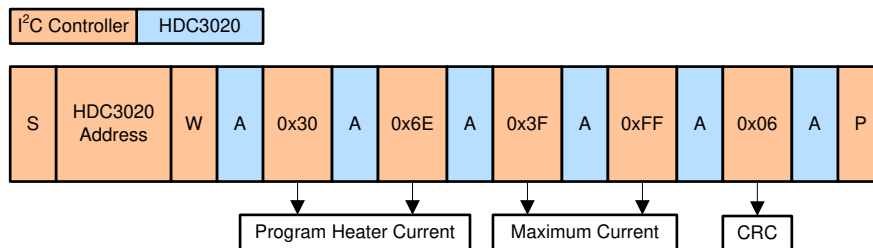

**Figure 8-37. I<sup>2</sup>C Command Sequence: Configure Heater Current Full Power**

### 8.5.7.9 Read NIST ID/Serial Number

Each HDC302x is configured with a unique 48-bit value that is used to support NIST traceability of the temperature and relative humidity sensor. It can also be used to represent the unique serial number for that device. Three commands are required to read the full 48-bit value as illustrated in Figure 8-38, Figure 8-39, and Figure 8-40. Each command will return two bytes of NIST ID followed by a CRC byte. From MSB to LSB, the full device NIST ID is read as NIST\_ID\_5, NIST\_ID\_4, NIST\_ID\_3, NIST\_ID\_2, NIST\_ID\_1, and NIST\_ID\_0.

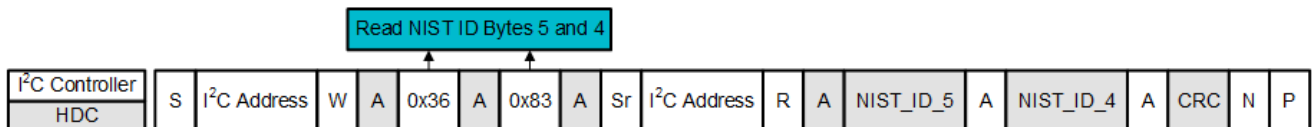

**Figure 8-38. I<sup>2</sup>C Command Sequence: Read NIST ID (Bytes NIST\_ID\_5, Then NIST\_ID\_4)**

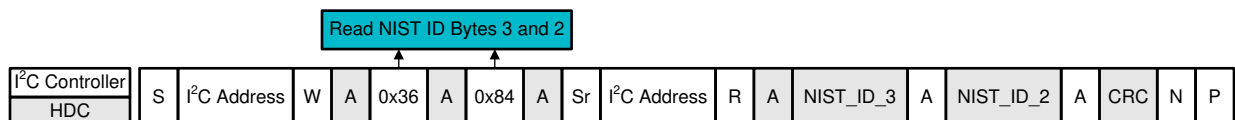

**Figure 8-39. I<sup>2</sup>C Command Sequence: Read NIST ID (Bytes NIST\_ID\_3, Then NIST\_ID\_2)**

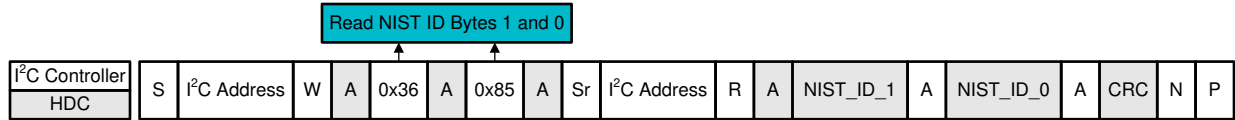

**Figure 8-40. I<sup>2</sup>C Command Sequence: Read NIST ID (Bytes NIST\_ID\_1, Then NIST\_ID\_0)**

## 9 Application and Implementation

---

### Note

Information in the following applications sections is not part of the TI component specification, and TI does not warrant its accuracy or completeness. TI's customers are responsible for determining suitability of components for their purposes, as well as validating and testing their design implementation to confirm system functionality.

---

### 9.1 Application Information

The HDC302x is used to measure the relative humidity and temperature of the board location where the device is mounted. The programmable I<sup>2</sup>C address option allow up to four locations be monitored on a single serial bus.

### 9.2 Typical Application

One common application which requires a relative humidity and temperature sensor is a HVAC system thermostat control. It is based on environmental sensors and a microcontroller. The microcontroller acquires data from humidity and temperature sensors and controls the heating and cooling system. The collected data are then shown on a display that can be easily controlled by the microcontroller. Based on data from the humidity and temperature sensor, the heating and cooling system then maintains the environment at the customer-defined preferred conditions.

Though a HVAC system thermostat is often line powered, low power is important in component selection, for energy star rating. The HDC302x, with 700 nA of current consumption (the average consumption over 1 second for RH and Temperature measurements), in conjunction with a MSP430, represents one way an engineer can obtain low power consumption. A system block diagram of a thermostat is shown in [Figure 9-1](#).

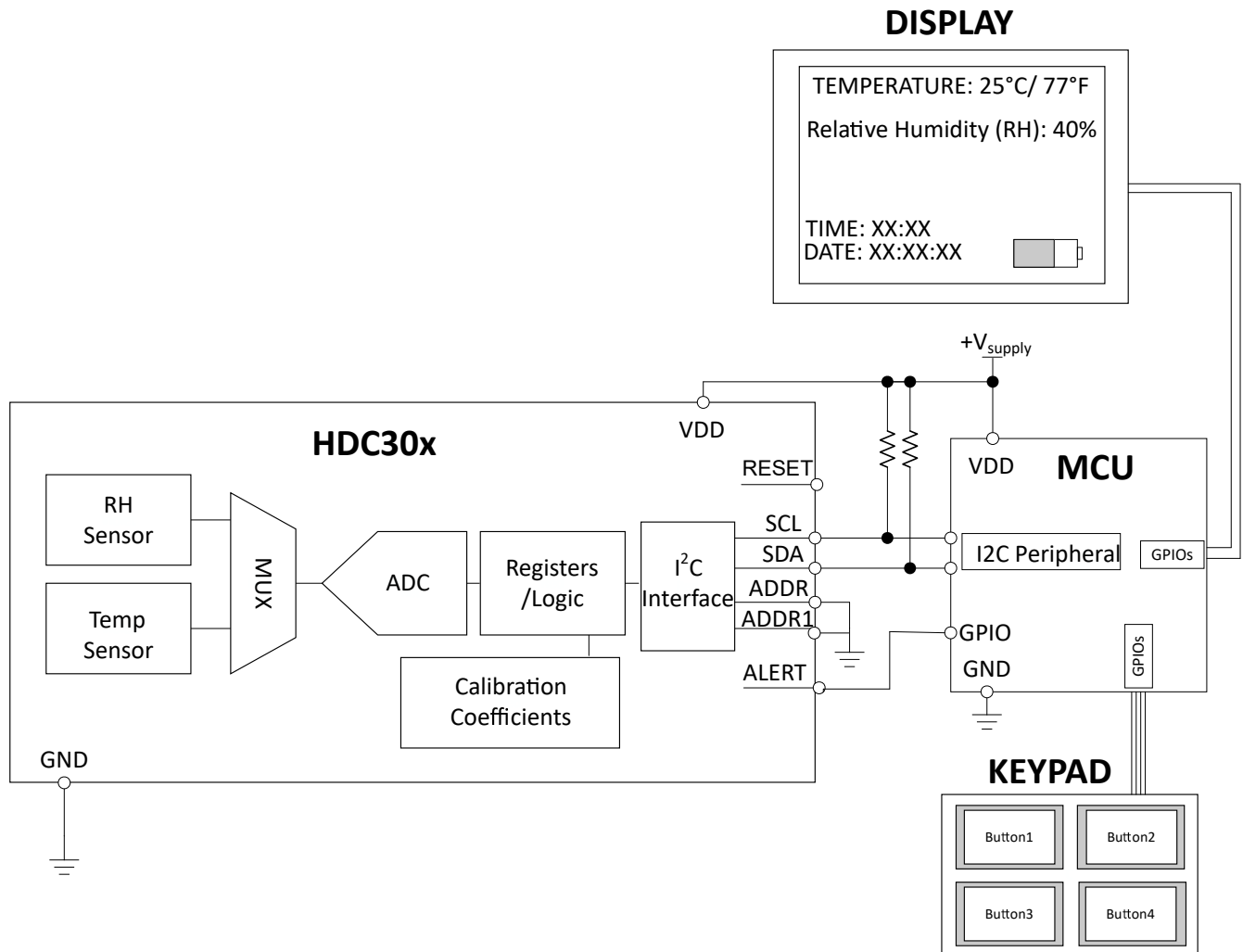

**Figure 9-1. Typical Application Schematic HVAC**

### 9.2.1 Design Requirements

To improve measurement accuracy, TI recommends to isolate the HDC302x from all heat sources in the form of active circuitry, batteries, displays and resistive elements. If design space is a constraint, cutouts surrounding the device or the inclusion of small trenches can help minimize heat transfer from PCB heat sources to the HDC302x. To avoid self-heating the HDC302x, TI recommends to configure the device to no faster than 1 measurement/second.

The HDC302x operates only as a target device and communicates with the host through the I2C-compatible serial interface. SCL is an input pin, SDA is a bidirectional pin, and ALERT is an output. The HDC302x requires a pullup resistor on the SDA. An SCL pullup resistor is required if the system microprocessor SCL pin is open-drain. The recommended value for the pullup resistors is generally 5 k $\Omega$ . In some applications, the pullup resistor can be lower or higher than 5 k $\Omega$ . The size of the pullup resistor is determined by the amount of capacitance on the I2C lines and the communication frequency. For further details, see the [I<sup>2</sup>C Pullup Resistor Calculation application note](#). A 0.1- $\mu$ F bypass capacitor is recommended to be connected between V+ and GND. Use a ceramic capacitor type with a temperature rating that matches the operating range of the application, and place the capacitor as close as possible to the VDD pin of the HDC302x. The ADDR and ADDR0 pins should be connected directly to GND or VDD for address selection of four possible unique target ID addresses per the addressing scheme (see [Table 8-2](#)). The ALERT output pin can be connected to a microcontroller interrupt that triggers an event that occurred when the relative humidity and/or temperature limit exceeds the programmed value. The ALERT pin should be left floating when not in use.

It is generally best practice to solder the package thermal pad to a board pad that is connected to ground, however to minimize thermal mass for maximum heater efficiency or to measure ambient temperature it may be left floating.

### 9.2.2 Detailed Design Procedure

When a circuit board layout is created from the schematic shown in [Figure 9-1](#), a small circuit board is possible. The accuracy of a temperature and relative humidity measurement is dependent upon the sensor accuracy and the setup of the sensing system. Since the HDC302x measures relative humidity and temperature in its immediate environment, it is critical that the local conditions at the sensor match the ambient environment. Use one or more openings in the physical cover over the device to obtain a good airflow even in static conditions. Refer to the layout [Figure 9-3](#) for a PCB layout which minimizes the thermal mass of the PCB in the region of the HDC302x, which can improve measurement response time and accuracy.

### 9.2.3 Application Curve

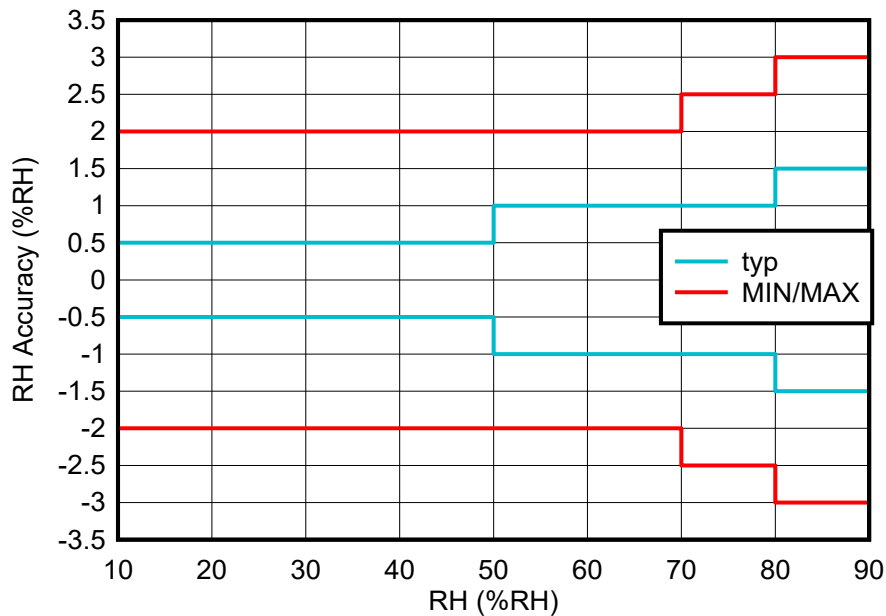

Figure 9-2. RH Accuracy vs RH

## 9.3 Power Supply Recommendations

The HDC302x supports a voltage supply range from 1.62 V up to 5.50 V. TI recommends a multilayer ceramic bypass X7R capacitor of 0.1  $\mu$ F between the  $V_{DD}$  and GND pins.

## 9.4 Layout

### 9.4.1 Layout Guidelines

Proper PCB layout of the HDC302x is critical to obtaining accurate measurements of temperature and relative humidity. Therefore, TI recommends to:

1. Isolate all heat sources from the HDC302x. This means positioning the HDC302x away from power intensive board components such as a battery, display, or microcontroller. Ideally, the only onboard component close to the HDC302x is the supply bypass capacitor. See the [Layout Example](#) for more information.
2. Eliminate copper layers below the device (GND,  $V_{DD}$ ).
3. Use slots or a cutout around the device to reduce the thermal mass and obtain a quicker response time to sudden environmental changes.
  - The diameter of the cutout around the part in this case is approximately 6 mm. The important details are to implement a separation of thermal planes while allowing for power, ground and data lines and place the part on the board, while still meeting mechanical assembly requirements. In addition to the [Layout](#)

*Example*, other representations of cutouts for thermal relief can be found in *Optimizing Placement and Routing for Humidity Sensors* section 2.3.

4. Follow the Example Board Layout and Example Stencil Design that is illustrated in *Mechanical, Packaging, and Orderable Information*.
  - The SCL and the SDA lines require pull up resistors and TI recommends to connect a 0.1-uF cap to the VDD line.
  - TI recommends a multilayer ceramic bypass X7R capacitor of 0.1  $\mu$ F between the VDD and GND pins.
5. It is generally best practice to solder the package thermal pad to a board pad that is connected to ground, however to minimize thermal mass for maximum heater efficiency or to measure ambient temperature it may be left floating. Floating the thermal pad is an option because the thermal pad has a non-conductive epoxy. See *HDC3x Silicon User's Guide* for more information regarding when leaving the thermal pad floating may be helpful for your application.

### 9.4.2 Layout Example

It is generally best practice to solder the package thermal pad to a board pad that is connected to ground as is shown in the layout example below, however to minimize thermal mass for maximum heater efficiency or to measure ambient temperature it may be left floating. Floating the thermal pad is an option because the thermal pad has a non-conductive epoxy.

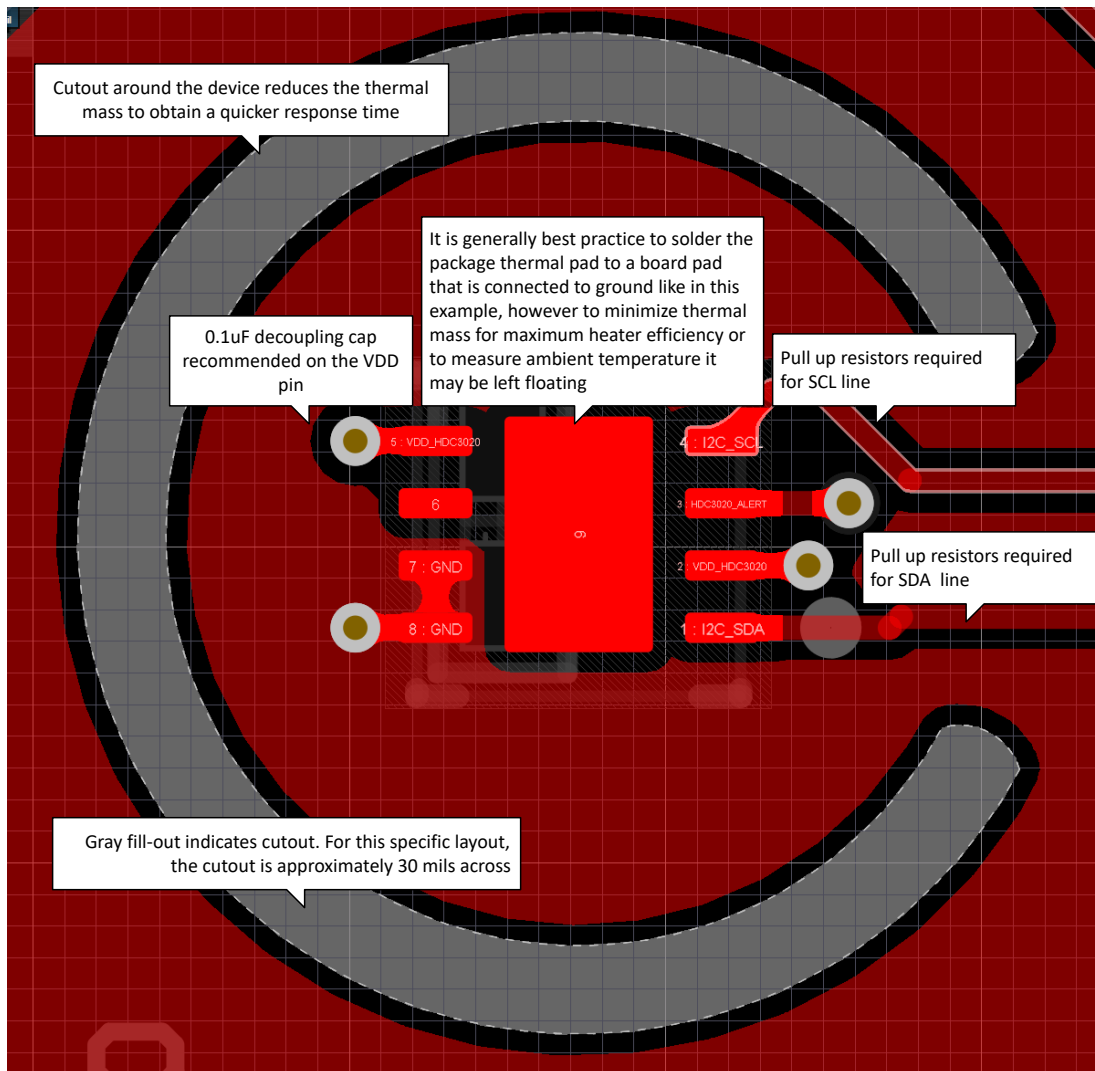

**Figure 9-3. HDC302x PCB Layout Example**

### 9.4.3 Storage and PCB Assembly

#### 9.4.3.1 Storage and Handling

As with all humidity sensors, the HDC302x must follow special guidelines regarding handling and storage that are not common with standard semiconductor devices. Long exposure to UV and visible light, or exposure to chemical vapors for prolonged periods, should be avoided as it may affect RH% accuracy. Additionally, the device should be protected from out-gassed solvent vapors produced during manufacturing, transport, operation, and package materials (that is, adhesive tapes, stickers, bubble foils). For further detailed information, see [HDC3x Silicon User's Guide](#).

#### 9.4.3.2 Soldering Reflow

For PCB assembly, standard reflow soldering ovens may be used. The HDC302x uses the standard soldering profile IPC/JEDEC J-STD-020 with peak temperatures at 260°C. When soldering the HDC3020, it is mandatory to use *no-clean* solder paste, and the paste must not be exposed to water or solvent rinses during assembly because these contaminants may affect sensor accuracy. When soldering HDC3021 or HDC3022, both which have a protective cover which protects the sensor, these devices allow for PCB board wash. After reflow, it is expected that the sensor will generally output a shift in relative humidity, which will reduce over time as the sensor is exposed to typical indoor ambient conditions 25C and 50% RH for 5 days. Following this rehydration procedure allows the polymer to correctly settle after reflow and return to the calibrated RH accuracy.

#### 9.4.3.3 Rework

TI recommends to limit the HDC302x to a single IR reflow with no rework, but a second reflow may be possible if the following guidelines are met:

- The exposed polymer (humidity sensor) is kept clean and undamaged.
- No-clean solder paste is used and the process is not exposed to any liquids, such as water or solvents.
- The peak soldering temperature does not exceed 260°C.

#### 9.4.3.4 Exposure to High Temperature and High Humidity Conditions

Long exposure outside the recommended operating conditions may temporarily offset the RH output. The recommended humidity operating range is 10 to 90% RH (non-condensing) over -20°C to 70°C. Prolonged operation beyond these ranges may shift the sensor reading with a slow recovery time.

#### 9.4.3.5 Bake/Rehydration Procedure

Prolonged exposure to extreme conditions or harsh contaminants may impact sensor performance. In the case that permanent offset is observed from contaminants, the following procedure is suggested, which may recover or reduce the error observed in sensor performance:

1. Baking: 100°C, at less than 5%RH, for 5 to 10 hours
2. Rehydration: 25°C and 50%RH for 5 days

## 10 Device and Documentation Support

### 10.1 Documentation Support

#### 10.1.1 Related Documentation

For related documentation, see the following:

- Texas Instruments, [Humidity Sensor: Storage and Handling Guidelines application report](#) (SNIA025)
- Texas Instruments, [Optimizing Placement and Routing for Humidity Sensors application report](#) (SNAA297)
- Texas Instruments, [HDC3020 EVM User's Guide](#) (SNAU267)
- Texas Instruments, [HDC3x Silicon User's Guide](#) (SNAU265)
- Texas Instruments, [I<sup>2</sup>C Pullup Resistor Calculation application note](#) (SLVA689)
- Texas Instruments, [85°C/85% RH Accelerated Life Test Impact on Humidity Sensors white paper](#) (SLYY210)
- Texas Instruments, [Leveraging Relative Humidity Sensor Enhanced Features for Ultra-Low-Power System application note](#) (SNAA352)
- Texas Instruments, [How the HDC3020 Humidity Sensor Family Achieves The Industry's Lowest Drift application note](#) (SNAA353)
- Texas Instruments, [Why long-term consistent performance matters for relative humidity sensors technical article](#)
- Texas Instruments, [Interface to sensors in seconds with ASC Studio technical article](#)

#### 10.2 Receiving Notification of Documentation Updates

To receive notification of documentation updates, navigate to the device product folder on [ti.com](#). Click on *Subscribe to updates* to register and receive a weekly digest of any product information that has changed. For change details, review the revision history included in any revised document.

#### 10.3 Support Resources

[TI E2E™ support forums](#) are an engineer's go-to source for fast, verified answers and design help — straight from the experts. Search existing answers or ask your own question to get the quick design help you need.

Linked content is provided "AS IS" by the respective contributors. They do not constitute TI specifications and do not necessarily reflect TI's views; see TI's [Terms of Use](#).

#### 10.4 Trademarks

TI E2E™ is a trademark of Texas Instruments.

All trademarks are the property of their respective owners.

#### 10.5 Electrostatic Discharge Caution



This integrated circuit can be damaged by ESD. Texas Instruments recommends that all integrated circuits be handled with appropriate precautions. Failure to observe proper handling and installation procedures can cause damage.

ESD damage can range from subtle performance degradation to complete device failure. Precision integrated circuits may be more susceptible to damage because very small parametric changes could cause the device not to meet its published specifications.

#### 10.6 Glossary

[TI Glossary](#) This glossary lists and explains terms, acronyms, and definitions.

## 11 Mechanical, Packaging, and Orderable Information

The following pages include mechanical, packaging, and orderable information. This information is the most current data available for the designated devices. This data is subject to change without notice and revision of this document. For browser-based versions of this data sheet, refer to the left-hand navigation.



**DEF0008A-C01**

**PACKAGE OUTLINE**  
**WSON - 0.8 mm max height**

PLASTIC SMALL OUTLINE - NO LEAD

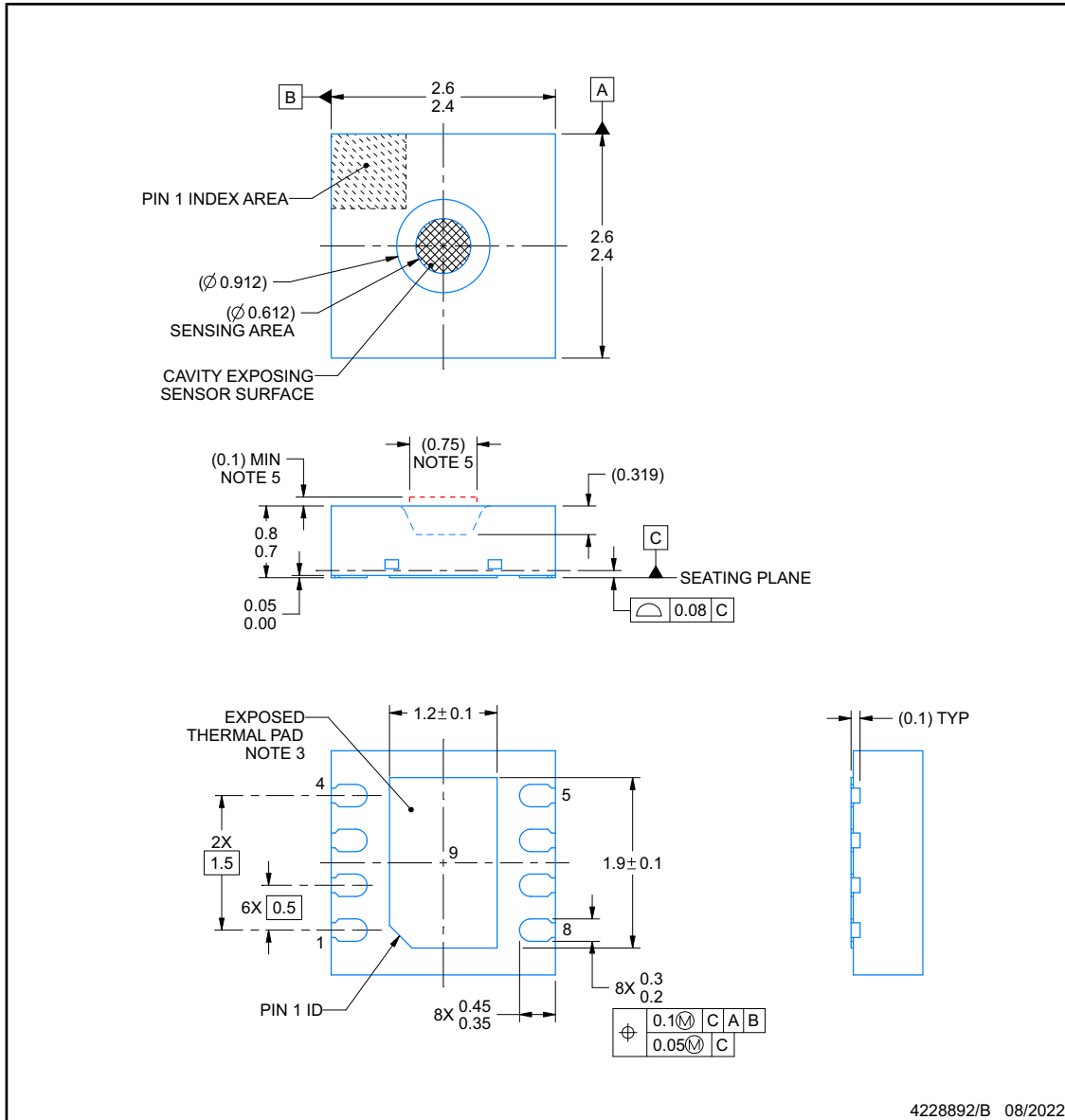

**NOTES:**

1. All linear dimensions are in millimeters. Any dimensions in parenthesis are for reference only. Dimensioning and tolerancing per ASME Y14.5M.
2. This drawing is subject to change without notice.
3. It is generally best practice to solder the package thermal pad to a board pad that is connected to ground, however to minimize thermal mass for maximum heater efficiency or to measure ambient temperature it may be left floating.
4. The pick and place nozzle internal diameter has to be between  $\varnothing 0.915$  and  $\varnothing 1.875$  mm.
5. Customers must maintain adequate clearance from this region to allow for proper functioning of the humidity sensor.

## EXAMPLE BOARD LAYOUT

**DEF0008A-C01**

**WSN - 0.8 mm max height**

PLASTIC SMALL OUTLINE - NO LEAD

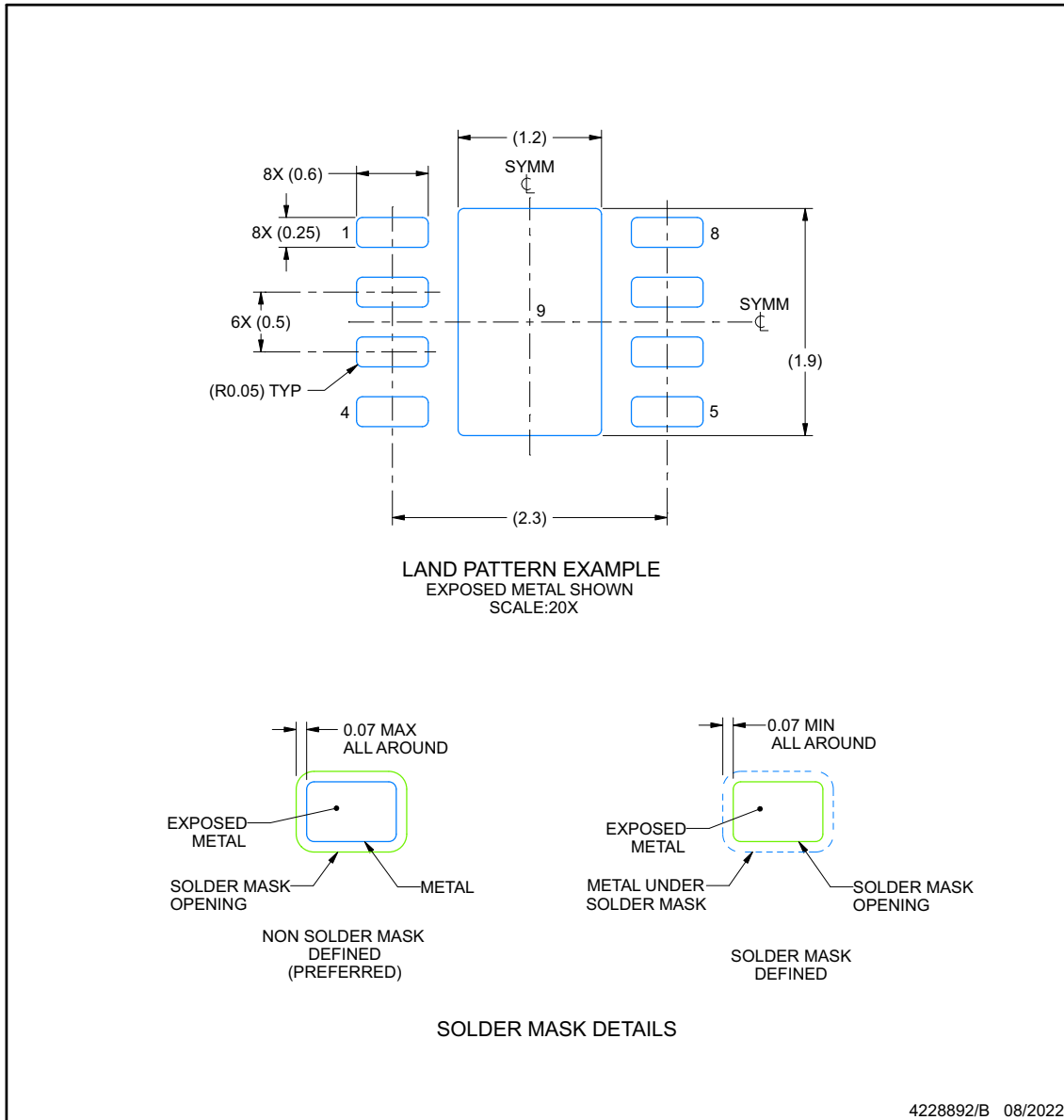

NOTES: (continued)

6. This package is designed to be soldered to a thermal pad on the board. For more information, see Texas Instruments literature number SLUA271 ([www.ti.com/lit/slua271](http://www.ti.com/lit/slua271)).
7. Vias are optional depending on application, refer to device data sheet. If any vias are implemented, refer to their locations shown on this view. It is recommended that vias under paste be filled, plugged or tented.

## EXAMPLE STENCIL DESIGN

**DEF0008A-C01**

**WSON - 0.8 mm max height**

PLASTIC SMALL OUTLINE - NO LEAD

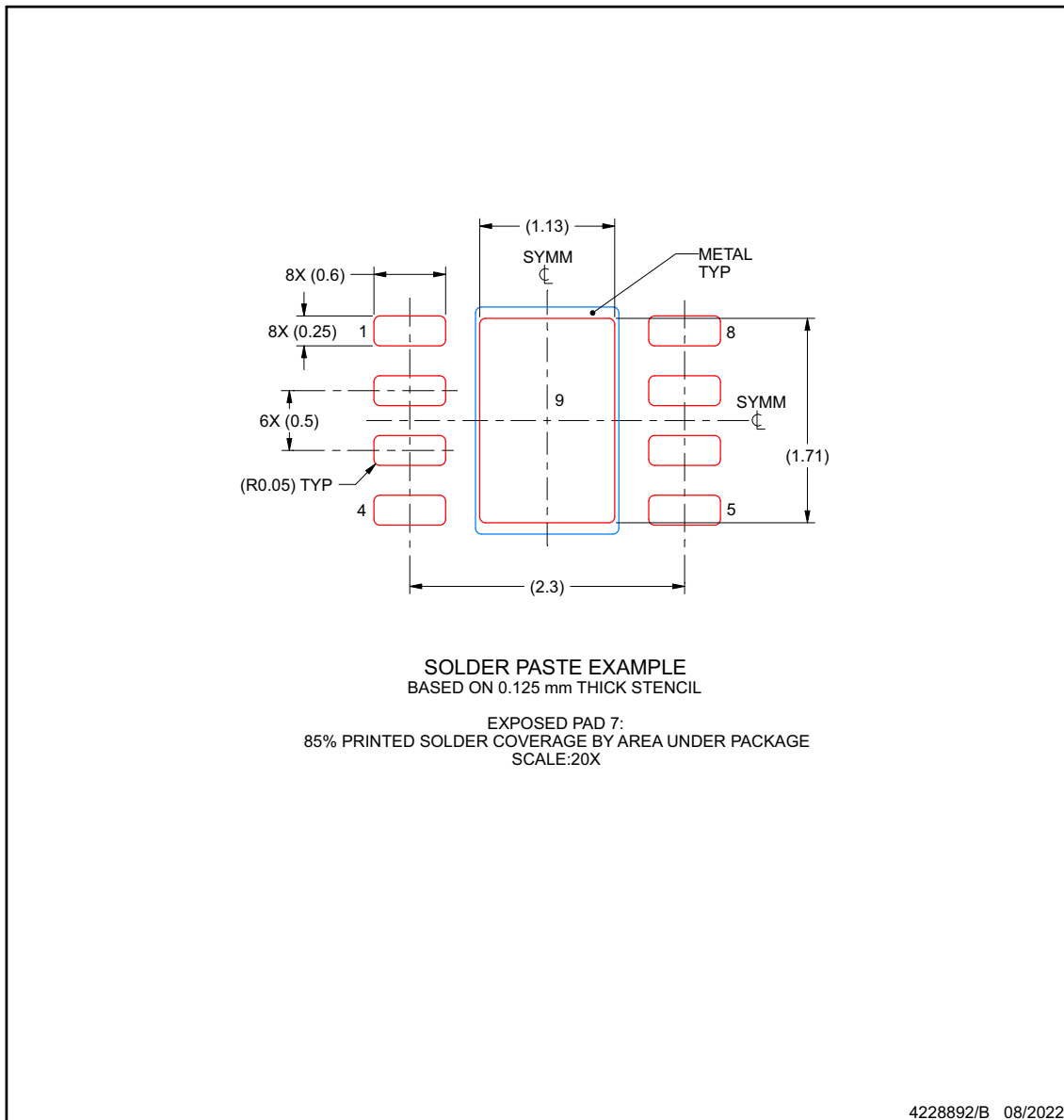

NOTES: (continued)

- 8. Laser cutting apertures with trapezoidal walls and rounded corners may offer better paste release. IPC-7525 may have alternate design recommendations.



**PACKAGE OUTLINE**

**DEH0008A-C01**

**WSON - 1.04 mm max height**

PLASTIC SMALL OUTLINE - NO LEAD

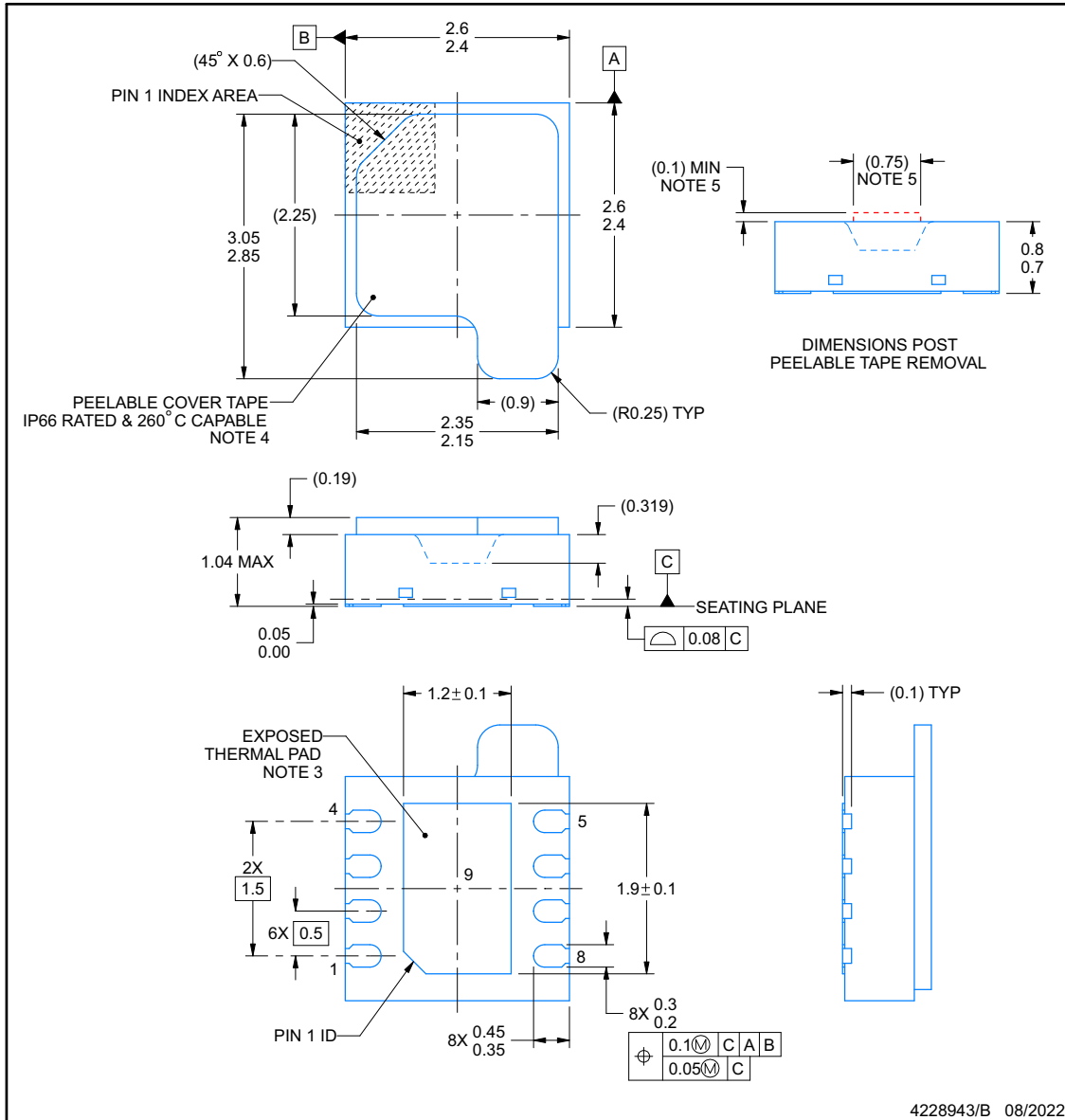

**NOTES:**

1. All linear dimensions are in millimeters. Any dimensions in parenthesis are for reference only. Dimensioning and tolerancing per ASME Y14.5M.
2. This drawing is subject to change without notice.
3. It is generally best practice to solder the package thermal pad to a board pad that is connected to ground, however to minimize thermal mass for maximum heater efficiency or to measure ambient temperature it may be left floating.
4. IPXY Rating represents environmental ingress protection from both dust and high pressure water sprays. X=6 represents resistance to dust and Y=6 represents high pressure water spray resistance per IEC60529 testing conditions.
5. Customers must maintain adequate clearance from this region to allow for proper functioning of the humidity sensor.

## EXAMPLE BOARD LAYOUT

**DEH0008A-C01**

**WSON - 1.04 mm max height**

PLASTIC SMALL OUTLINE - NO LEAD

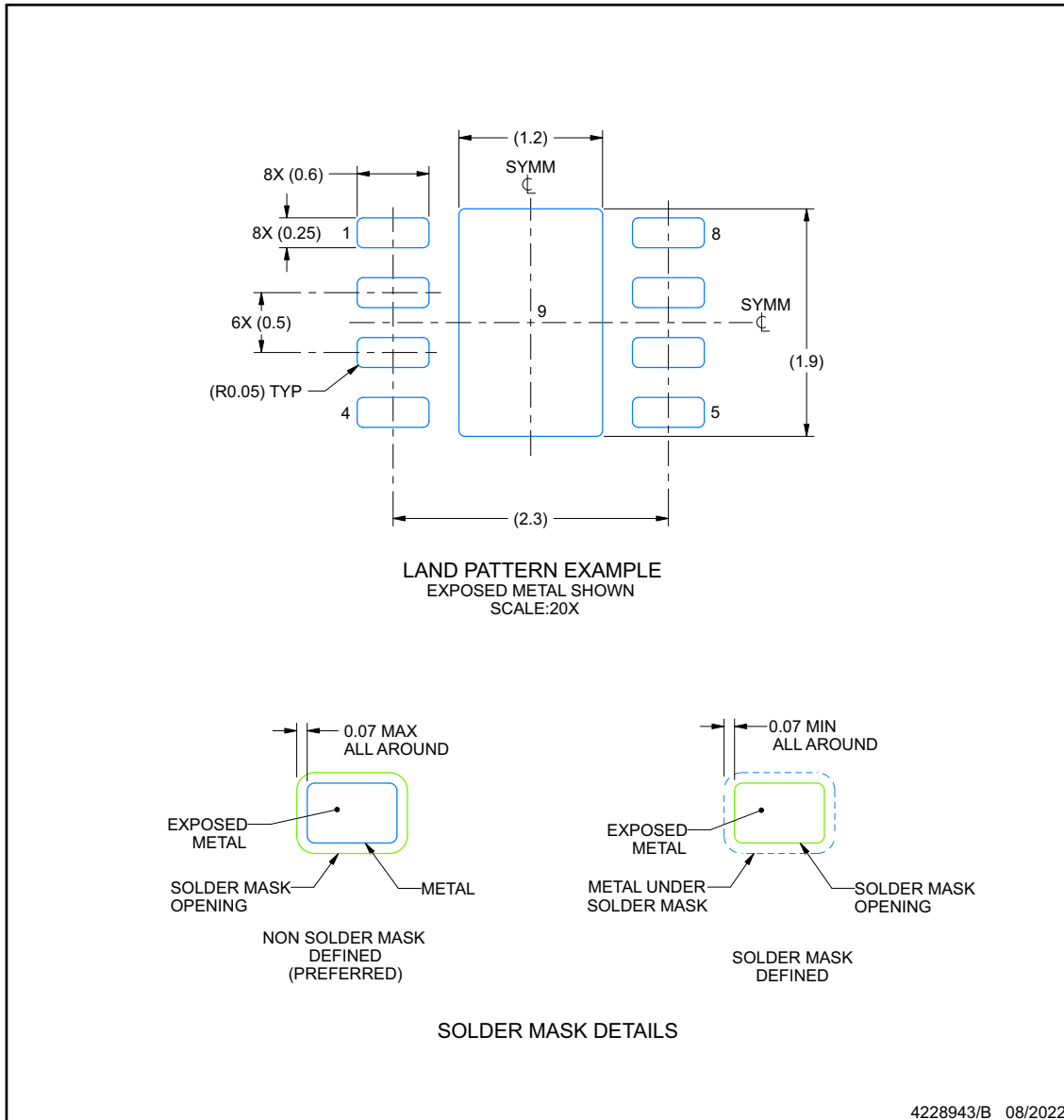

NOTES: (continued)

6. This package is designed to be soldered to a thermal pad on the board. For more information, see Texas Instruments literature number SLUA271 ([www.ti.com/lit/slua271](http://www.ti.com/lit/slua271)).
7. Vias are optional depending on application, refer to device data sheet. If any vias are implemented, refer to their locations shown on this view. It is recommended that vias under paste be filled, plugged or tented.

**EXAMPLE STENCIL DESIGN**

**DEH0008A-C01**

**WSON - 1.04 mm max height**

PLASTIC SMALL OUTLINE - NO LEAD

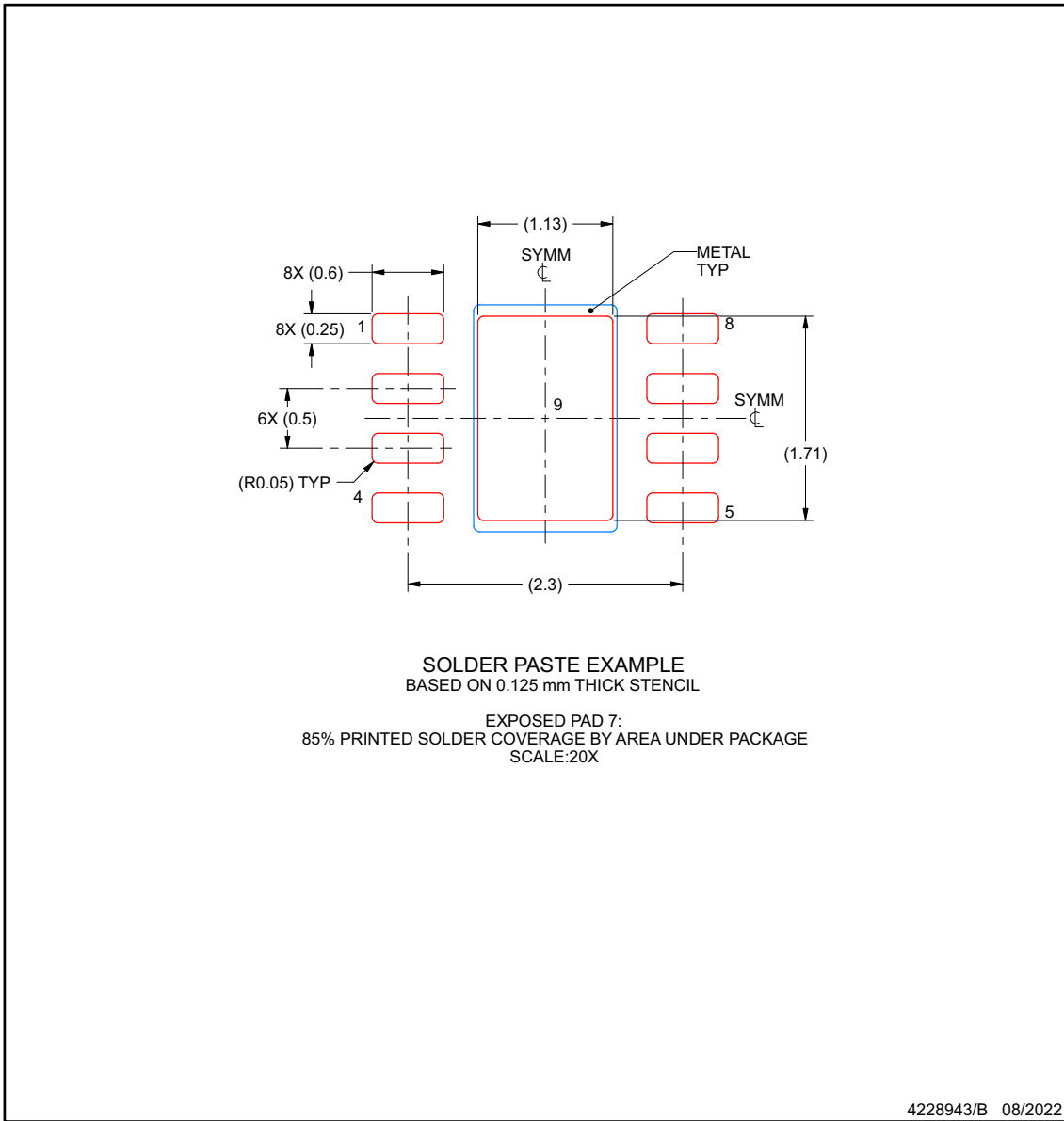

NOTES: (continued)

8. Laser cutting apertures with trapezoidal walls and rounded corners may offer better paste release. IPC-7525 may have alternate design recommendations.



**DEJ0008A-C01**

**PACKAGE OUTLINE**  
**WSON - 1.25 mm max height**

PLASTIC SMALL OUTLINE - NO LEAD

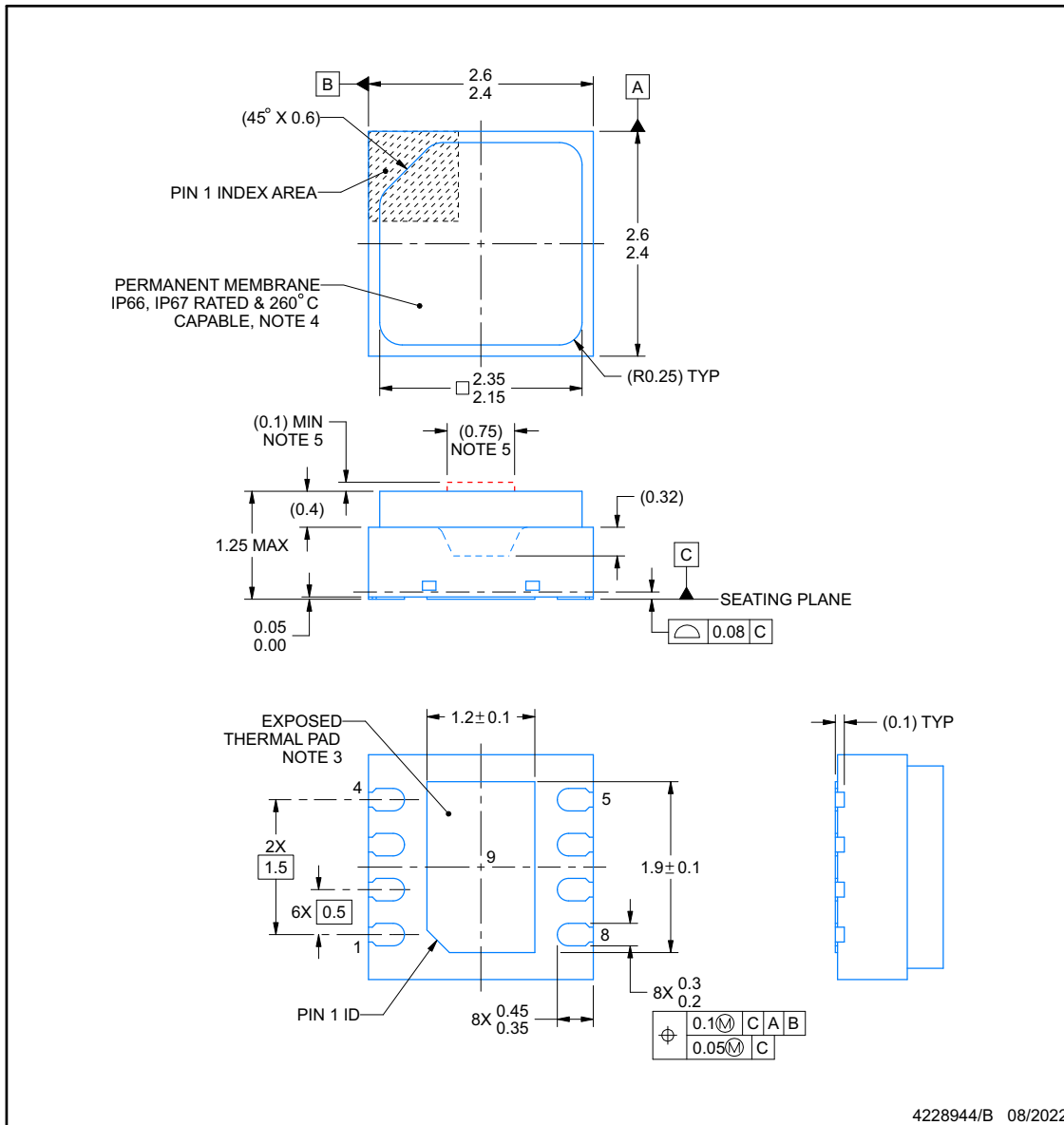

**NOTES:**

1. All linear dimensions are in millimeters. Any dimensions in parenthesis are for reference only. Dimensioning and tolerancing per ASME Y14.5M.
2. This drawing is subject to change without notice.
3. It is generally best practice to solder the package thermal pad to a board pad that is connected to ground, however to minimize thermal mass for maximum heater efficiency or to measure ambient temperature it may be left floating.
4. IPXY Rating represents environmental ingress protection from both dust and high pressure water sprays. X=6 represents resistance to dust, Y=6 represents high pressure water spray resistance and Y=7 allows 1m water submersion per IEC60529 testing conditions.
5. Customers must maintain adequate clearance from this region to allow for proper functioning of the humidity sensor.

## EXAMPLE BOARD LAYOUT

**DEJ0008A-C01**

**WSON - 1.25 mm max height**

PLASTIC SMALL OUTLINE - NO LEAD

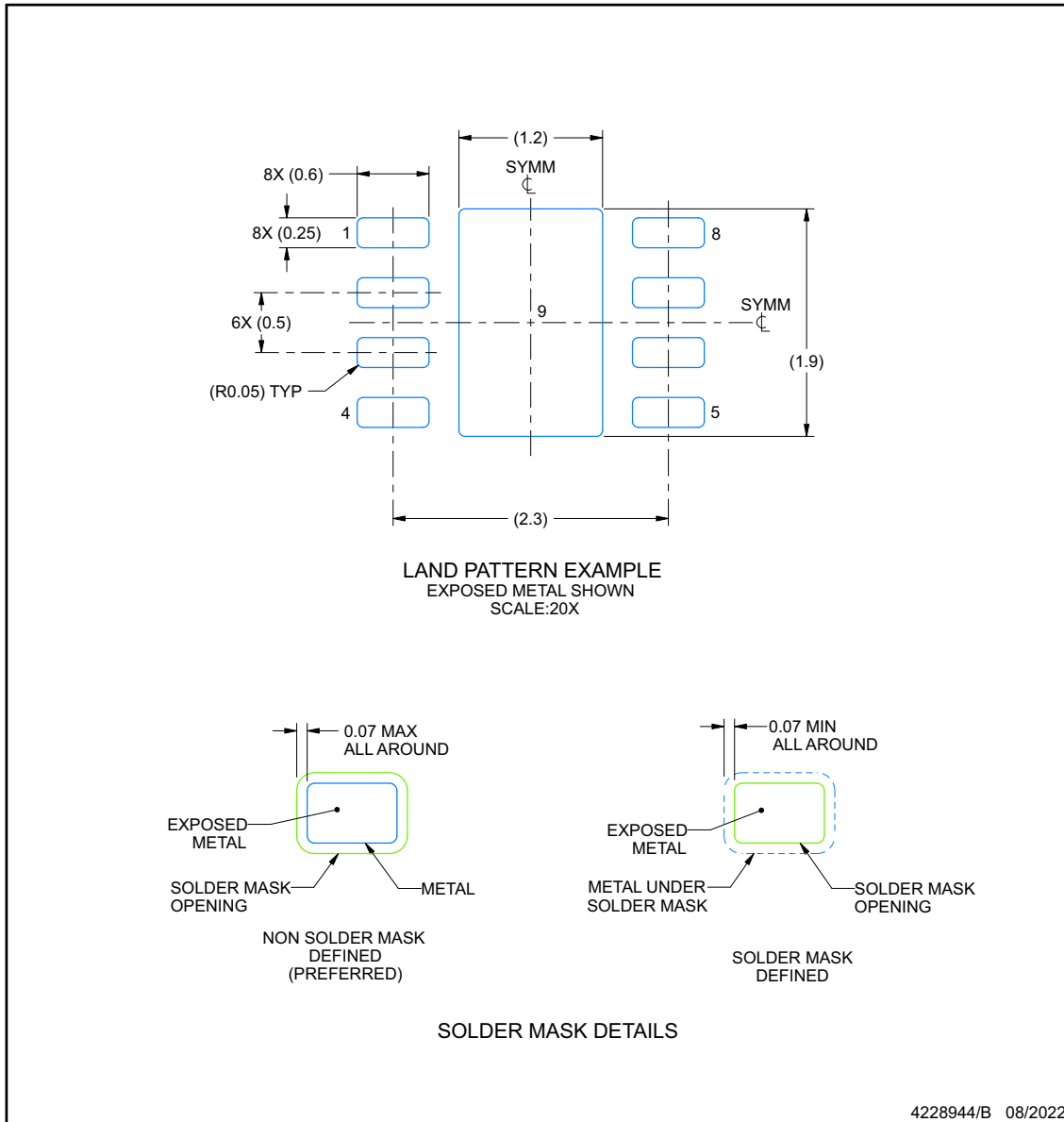

NOTES: (continued)

- This package is designed to be soldered to a thermal pad on the board. For more information, see Texas Instruments literature number SLUA271 ([www.ti.com/lit/slua271](http://www.ti.com/lit/slua271)).
- Vias are optional depending on application, refer to device data sheet. If any vias are implemented, refer to their locations shown on this view. It is recommended that vias under paste be filled, plugged or tented.

## EXAMPLE STENCIL DESIGN

**DEJ0008A-C01**

**WSON - 1.25 mm max height**

PLASTIC SMALL OUTLINE - NO LEAD

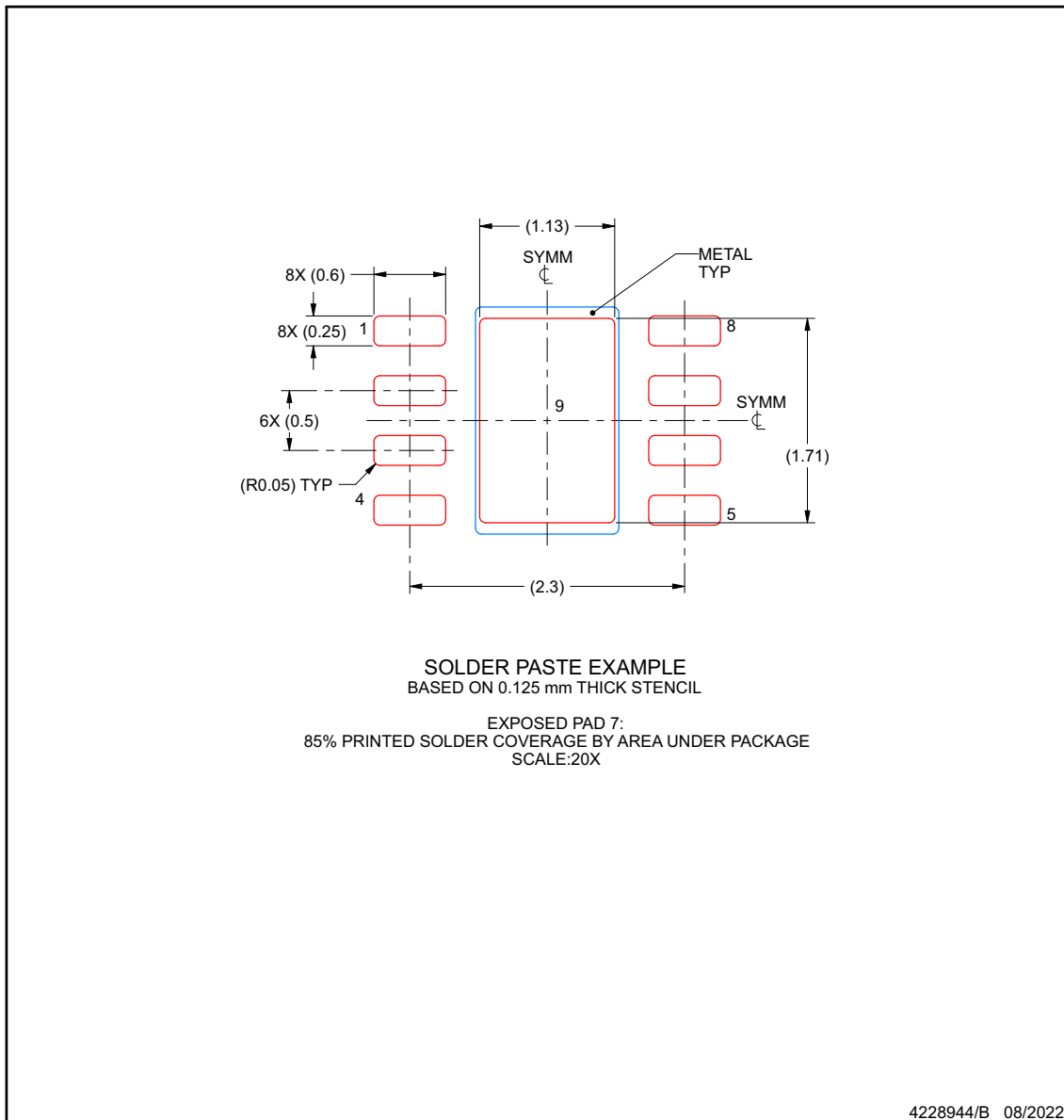

NOTES: (continued)

- 8. Laser cutting apertures with trapezoidal walls and rounded corners may offer better paste release. IPC-7525 may have alternate design recommendations.

**PACKAGING INFORMATION**

Orderable Device	Status (1)	Package Type	Package Drawing	Pins	Package Qty	Eco Plan (2)	Lead finish/ Ball material (6)	MSL Peak Temp (3)	Op Temp (°C)	Device Marking (4/5)	Samples
HDC3020DEFR	ACTIVE	WSO	DEF	8	3000	RoHS & Green	NIPDAU	Level-1-260C-UNLIM	-40 to 125	P G	<a href="#">Samples</a>
HDC3021DEHR	ACTIVE	WSO	DEH	8	3000	RoHS & Green	NIPDAU	Level-1-260C-UNLIM	-40 to 125	P H	<a href="#">Samples</a>
HDC3022DEJR	ACTIVE	WSO	DEJ	8	3000	RoHS & Green	NIPDAU	Level-1-260C-UNLIM	-40 to 125	P J	<a href="#">Samples</a>

(1) The marketing status values are defined as follows:

**ACTIVE:** Product device recommended for new designs.

**LIFEBUY:** TI has announced that the device will be discontinued, and a lifetime-buy period is in effect.

**NRND:** Not recommended for new designs. Device is in production to support existing customers, but TI does not recommend using this part in a new design.

**PREVIEW:** Device has been announced but is not in production. Samples may or may not be available.

**OBSELETE:** TI has discontinued the production of the device.

(2) **RoHS:** TI defines "RoHS" to mean semiconductor products that are compliant with the current EU RoHS requirements for all 10 RoHS substances, including the requirement that RoHS substance do not exceed 0.1% by weight in homogeneous materials. Where designed to be soldered at high temperatures, "RoHS" products are suitable for use in specified lead-free processes. TI may reference these types of products as "Pb-Free".

**RoHS Exempt:** TI defines "RoHS Exempt" to mean products that contain lead but are compliant with EU RoHS pursuant to a specific EU RoHS exemption.

**Green:** TI defines "Green" to mean the content of Chlorine (Cl) and Bromine (Br) based flame retardants meet JS709B low halogen requirements of <=1000ppm threshold. Antimony trioxide based flame retardants must also meet the <=1000ppm threshold requirement.

(3) MSL, Peak Temp. - The Moisture Sensitivity Level rating according to the JEDEC industry standard classifications, and peak solder temperature.

(4) There may be additional marking, which relates to the logo, the lot trace code information, or the environmental category on the device.

(5) Multiple Device Markings will be inside parentheses. Only one Device Marking contained in parentheses and separated by a "~" will appear on a device. If a line is indented then it is a continuation of the previous line and the two combined represent the entire Device Marking for that device.

(6) Lead finish/Ball material - Orderable Devices may have multiple material finish options. Finish options are separated by a vertical ruled line. Lead finish/Ball material values may wrap to two lines if the finish value exceeds the maximum column width.

**Important Information and Disclaimer:**The information provided on this page represents TI's knowledge and belief as of the date that it is provided. TI bases its knowledge and belief on information provided by third parties, and makes no representation or warranty as to the accuracy of such information. Efforts are underway to better integrate information from third parties. TI has taken and continues to take reasonable steps to provide representative and accurate information but may not have conducted destructive testing or chemical analysis on incoming materials and chemicals. TI and TI suppliers consider certain information to be proprietary, and thus CAS numbers and other limited information may not be available for release.

In no event shall TI's liability arising out of such information exceed the total purchase price of the TI part(s) at issue in this document sold by TI to Customer on an annual basis.

**OTHER QUALIFIED VERSIONS OF HDC3020, HDC3021 :**

- Automotive : [HDC3020-Q1](#), [HDC3021-Q1](#)

**NOTE: Qualified Version Definitions:**

- Automotive - Q100 devices qualified for high-reliability automotive applications targeting zero defects

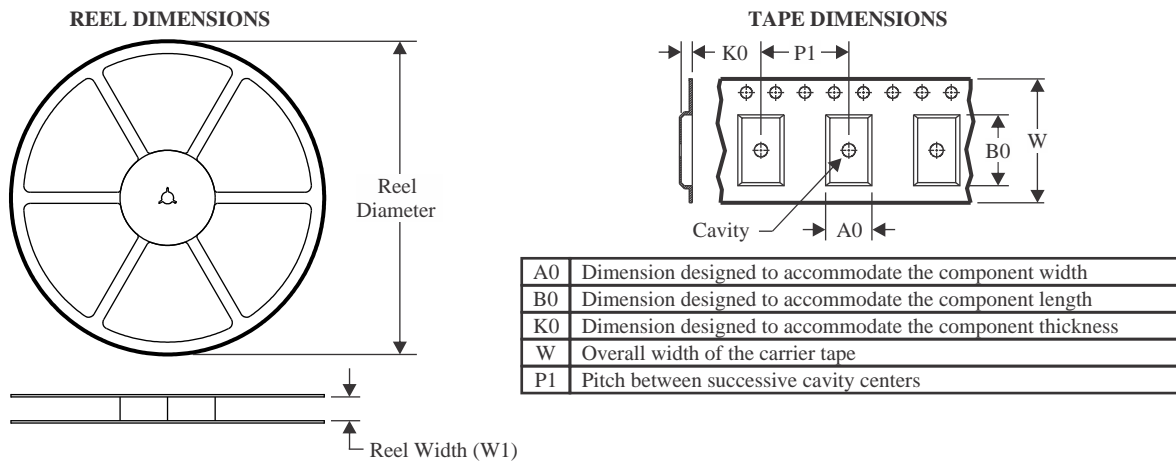
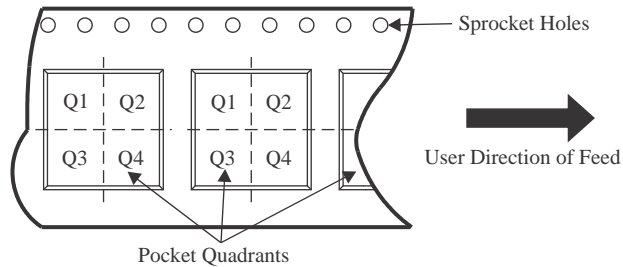
**TAPE AND REEL INFORMATION**

**QUADRANT ASSIGNMENTS FOR PIN 1 ORIENTATION IN TAPE**

\*All dimensions are nominal

Device	Package Type	Package Drawing	Pins	SPQ	Reel Diameter (mm)	Reel Width W1 (mm)	A0 (mm)	B0 (mm)	K0 (mm)	P1 (mm)	W (mm)	Pin1 Quadrant
HDC3020DEFR	WSON	DEF	8	3000	330.0	12.4	2.75	2.75	1.3	8.0	12.0	Q1
HDC3021DEHR	WSON	DEH	8	3000	330.0	12.4	2.8	2.8	1.1	8.0	12.0	Q1
HDC3022DEJR	WSON	DEJ	8	3000	330.0	12.4	2.75	2.75	1.3	8.0	12.0	Q1

**TAPE AND REEL BOX DIMENSIONS**

\*All dimensions are nominal

Device	Package Type	Package Drawing	Pins	SPQ	Length (mm)	Width (mm)	Height (mm)
HDC3020DEFR	WSON	DEF	8	3000	356.0	338.0	48.0
HDC3021DEHR	WSON	DEH	8	3000	356.0	338.0	48.0
HDC3022DEJR	WSON	DEJ	8	3000	356.0	338.0	48.0

## IMPORTANT NOTICE AND DISCLAIMER

TI PROVIDES TECHNICAL AND RELIABILITY DATA (INCLUDING DATA SHEETS), DESIGN RESOURCES (INCLUDING REFERENCE DESIGNS), APPLICATION OR OTHER DESIGN ADVICE, WEB TOOLS, SAFETY INFORMATION, AND OTHER RESOURCES "AS IS" AND WITH ALL FAULTS, AND DISCLAIMS ALL WARRANTIES, EXPRESS AND IMPLIED, INCLUDING WITHOUT LIMITATION ANY IMPLIED WARRANTIES OF MERCHANTABILITY, FITNESS FOR A PARTICULAR PURPOSE OR NON-INFRINGEMENT OF THIRD PARTY INTELLECTUAL PROPERTY RIGHTS.

These resources are intended for skilled developers designing with TI products. You are solely responsible for (1) selecting the appropriate TI products for your application, (2) designing, validating and testing your application, and (3) ensuring your application meets applicable standards, and any other safety, security, regulatory or other requirements.

These resources are subject to change without notice. TI grants you permission to use these resources only for development of an application that uses the TI products described in the resource. Other reproduction and display of these resources is prohibited. No license is granted to any other TI intellectual property right or to any third party intellectual property right. TI disclaims responsibility for, and you will fully indemnify TI and its representatives against, any claims, damages, costs, losses, and liabilities arising out of your use of these resources.

TI's products are provided subject to [TI's Terms of Sale](#) or other applicable terms available either on [ti.com](https://www.ti.com) or provided in conjunction with such TI products. TI's provision of these resources does not expand or otherwise alter TI's applicable warranties or warranty disclaimers for TI products.

TI objects to and rejects any additional or different terms you may have proposed.

Mailing Address: Texas Instruments, Post Office Box 655303, Dallas, Texas 75265  
Copyright © 2023, Texas Instruments Incorporated

## Looking for pricing, stock, or lifecycle information?

Click below to explore more details on WIN SOURCE:

 [View HDC3021DEHR on WIN SOURCE](#)

 [Texas Instruments](#) Information

## Optimize Your Supply Chain with WIN SOURCE Solutions

-  Global Sourcing Solution
-  Obsolete Management
-  Cost Control Management
-  Shortage Management
-  Alternative Solution
-  Excess Inventory Management