



**THE DATASHEET OF  
74AVC4T3144GU12X**



# 74AVC4T3144

4-bit dual-supply buffer/level translator; 3-state

Rev. 3 — 2 July 2024

Product data sheet

## 1. General description

The 74AVC4T3144 is a 4-bit, dual-supply level translating buffer with 3-state outputs. It features four data inputs (An and B4), four data outputs (YBn and YA4), and an output enable input ( $\overline{OE}$ ). The device is configured to translate three inputs from  $V_{CC(A)}$  to  $V_{CC(B)}$  and one input from  $V_{CC(B)}$  to  $V_{CC(A)}$ .  $\overline{OE}$ , An and YA4 are referenced to  $V_{CC(A)}$  and YBn and B4 are referenced to  $V_{CC(B)}$ . A HIGH on  $\overline{OE}$  causes the outputs to assume a high-impedance OFF-state.

The device is fully specified for partial power-down applications using  $I_{OFF}$ . The  $I_{OFF}$  circuitry disables outputs, preventing any damaging backflow current through the device when it is powered down. In suspend mode when either  $V_{CC(A)}$  or  $V_{CC(B)}$  are at GND level, all outputs are in the high-impedance OFF-state.

## 2. Features and benefits

- Wide supply voltage range:
  - $V_{CC(A)}$ : 0.8 V to 3.6 V
  - $V_{CC(B)}$ : 0.8 V to 3.6 V
- Complies with JEDEC standards:
  - JESD8-12 (0.8 V to 1.3 V)
  - JESD8-11 (0.9 V to 1.65 V)
  - JESD8-7 (1.2 V to 1.95 V)
  - JESD8-5 (1.8 V to 2.7 V)
  - JESD8-B (2.7 V to 3.6 V)
- Maximum data rates:
  - 380 Mbit/s ( $\geq 1.8$  V to 3.3 V translation)
  - 200 Mbit/s ( $\geq 1.1$  V to 3.3 V translation)
  - 200 Mbit/s ( $\geq 1.1$  V to 2.5 V translation)
  - 200 Mbit/s ( $\geq 1.1$  V to 1.8 V translation)
  - 150 Mbit/s ( $\geq 1.1$  V to 1.5 V translation)
  - 100 Mbit/s ( $\geq 1.1$  V to 1.2 V translation)
- Suspend mode
- Latch-up performance exceeds 100 mA per JESD 78 Class II
- Inputs accept voltages up to 3.6 V
- $I_{OFF}$  circuitry provides partial Power-down mode operation
- ESD protection:
  - HBM: ANSI/ESDA/JEDEC JS-001 class 3B exceeds 8000 V
  - CDM: ANSI/ESDA/JEDEC JS-002 class C3 exceeds 1000 V
- Specified from  $-40$  °C to  $+85$  °C and  $-40$  °C to  $+125$  °C

### 3. Ordering information

Table 1. Ordering information

Type number	Package			Version
	Temperature range	Name	Description	
<a href="#">74AVC4T3144GU12</a>	-40 °C to +125 °C	XQFN12	plastic, extremely thin quad flat package; no leads; 12 terminals; body 1.70 × 2.0 × 0.50 mm	<a href="#">SOT1174-1</a>

### 4. Marking

Table 2. Marking codes

Type number	Marking code
74AVC4T3144GU12	Bd

### 5. Functional diagram

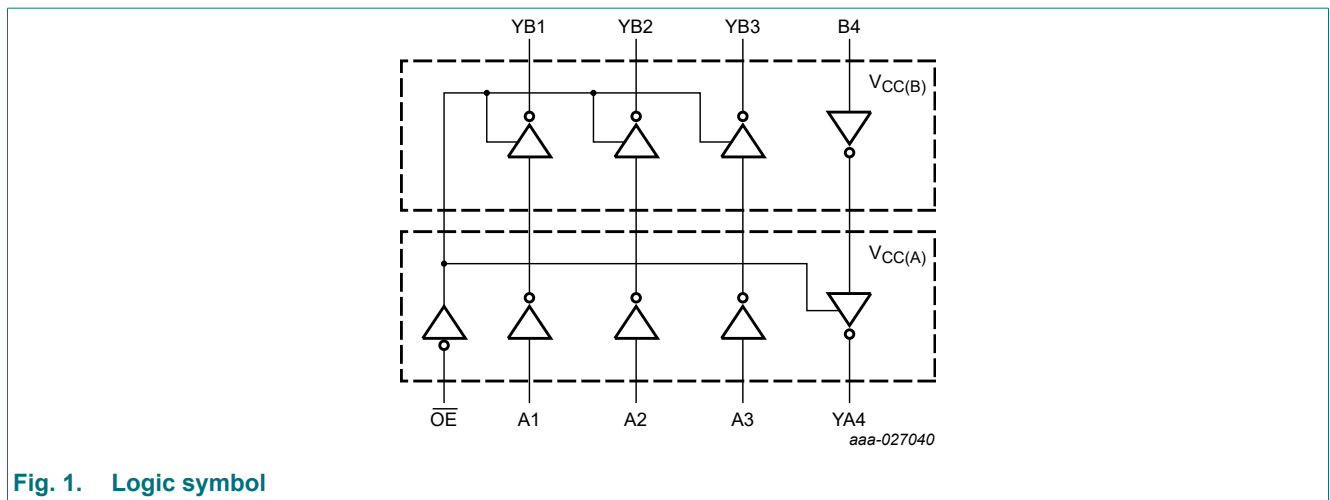

Fig. 1. Logic symbol

## 6. Pinning information

### 6.1. Pinning

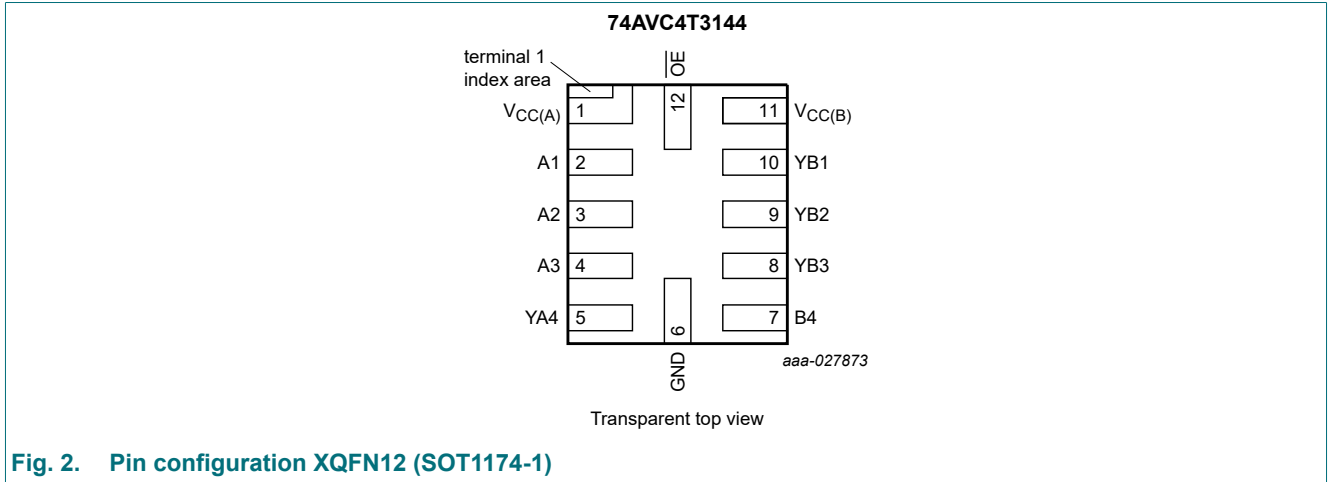

Fig. 2. Pin configuration XQFN12 (SOT1174-1)

### 6.2. Pin description

Table 3. Pin description

Symbol	Pin	Description
$V_{CC(A)}$	1	supply voltage A (A1, A2, A3, YA4 and $\overline{OE}$ pins are referenced to $V_{CC(A)}$ )
A1, A2, A3, B4	2, 3, 4, 7	data input
GND	6	ground (0 V)
YB1, YB2, YB3, YA4	10, 9, 8, 5	data output
$\overline{OE}$	12	output enable input (active LOW)
$V_{CC(B)}$	11	supply voltage B (YB1, YB2, YB3 and B4 pins are referenced to $V_{CC(B)}$ )

## 7. Functional description

Table 4. Function table

*H = HIGH voltage level; L = LOW voltage level; X = don't care; Z = high-impedance OFF-state.*

*The A1, A2, A3, YA4 and  $\overline{OE}$  pins are referenced to  $V_{CC(A)}$ ; The YB1, YB2, YB3 and B4 pins are referenced to  $V_{CC(B)}$ .*

Supply voltage	Input	Input	Output
$V_{CC(A)}, V_{CC(B)}$	$\overline{OE}$	An, B4	YBn, YA4
0.8 V to 3.6 V	L	L	L
0.8 V to 3.6 V	L	H	H
0.8 V to 3.6 V	H	X	Z
GND [1]	X	Z	Z

[1] If at least one of  $V_{CC(A)}$  or  $V_{CC(B)}$  is at GND level, the device goes into suspend mode.

## 8. Limiting values

**Table 5. Limiting values**

In accordance with the Absolute Maximum Rating System (IEC 60134). Voltages are referenced to GND (ground = 0 V).

Symbol	Parameter	Conditions	Min	Max	Unit
$V_{CC(A)}$	supply voltage A		-0.5	+4.6	V
$V_{CC(B)}$	supply voltage B		-0.5	+4.6	V
$I_{IK}$	input clamping current	$V_I < 0$ V	-50	-	mA
$V_I$	input voltage	[1]	-0.5	+4.6	V
$I_{OK}$	output clamping current	$V_O < 0$ V	-50	-	mA
$V_O$	output voltage	Active mode [1] [2] [3]	-0.5	$V_{CCO} + 0.5$	V
		Suspend or 3-state mode [1]	-0.5	+4.6	V
$I_O$	output current	$V_O = 0$ V to $V_{CCO}$ [2]	-	$\pm 50$	mA
$I_{CC}$	supply current	$I_{CC(A)}$ or $I_{CC(B)}$	-	100	mA
$I_{GND}$	ground current		-100	-	mA
$T_{stg}$	storage temperature		-65	+150	°C
$P_{tot}$	total power dissipation	$T_{amb} = -40$ °C to $+125$ °C	-	250	mW

- [1] The minimum input voltage ratings and output voltage ratings may be exceeded if the input and output current ratings are observed.  
 [2]  $V_{CCO}$  is the supply voltage associated with the output port.  
 [3]  $V_{CCO} + 0.5$  V should not exceed 4.6 V.

## 9. Recommended operating conditions

**Table 6. Recommended operating conditions**

Symbol	Parameter	Conditions	Min	Max	Unit
$V_{CC(A)}$	supply voltage A		0.8	3.6	V
$V_{CC(B)}$	supply voltage B		0.8	3.6	V
$V_I$	input voltage		0	3.6	V
$V_O$	output voltage	Active mode [1]	0	$V_{CCO}$	V
		Suspend or 3-state mode	0	3.6	V
$T_{amb}$	ambient temperature		-40	+125	°C
$\Delta t/\Delta V$	input transition rise and fall rate	$V_{CCI} = 0.8$ V to 3.6 V [2]	-	10	ns/V

- [1]  $V_{CCO}$  is the supply voltage associated with the output port.  
 [2]  $V_{CCI}$  is the supply voltage associated with the input port.

## 10. Static characteristics

**Table 7. Typical static characteristics at  $T_{amb} = 25\text{ °C}$  [1] [2]**

At recommended operating conditions; voltages are referenced to GND (ground = 0 V).

Symbol	Parameter	Conditions	Min	Typ	Max	Unit
$V_{OH}$	HIGH-level output voltage	$V_I = V_{IH}$ or $V_{IL}$				
		$I_O = -1.5\text{ mA}$ ; $V_{CC(A)} = V_{CC(B)} = 0.8\text{ V}$	-	0.69	-	V
$V_{OL}$	LOW-level output voltage	$V_I = V_{IH}$ or $V_{IL}$				
		$I_O = 1.5\text{ mA}$ ; $V_{CC(A)} = V_{CC(B)} = 0.8\text{ V}$	-	0.07	-	V
$I_I$	input leakage current	$\overline{OE}$ input; $V_I = 0\text{ V}$ or $3.6\text{ V}$ ; $V_{CC(A)} = V_{CC(B)} = 0.8\text{ V}$ to $3.6\text{ V}$	-	$\pm 0.025$	$\pm 0.25$	$\mu\text{A}$
$I_{OZ}$	OFF-state output current	A or B port; $V_O = 0\text{ V}$ or $V_{CCO}$ ; $V_{CC(A)} = V_{CC(B)} = 3.6\text{ V}$	-	$\pm 0.5$	$\pm 2.5$	$\mu\text{A}$
		suspend mode A port; $V_O = 0\text{ V}$ or $V_{CCO}$ ; $V_{CC(A)} = 3.6\text{ V}$ ; $V_{CC(B)} = 0\text{ V}$	-	$\pm 0.5$	$\pm 2.5$	$\mu\text{A}$
		suspend mode B port; $V_O = 0\text{ V}$ or $V_{CCO}$ ; $V_{CC(A)} = 0\text{ V}$ ; $V_{CC(B)} = 3.6\text{ V}$	-	$\pm 0.5$	$\pm 2.5$	$\mu\text{A}$
$I_{OFF}$	power-off leakage current	A port; $V_I$ or $V_O = 0\text{ V}$ to $3.6\text{ V}$ ; $V_{CC(A)} = 0\text{ V}$ ; $V_{CC(B)} = 0.8\text{ V}$ to $3.6\text{ V}$	-	$\pm 0.1$	$\pm 1$	$\mu\text{A}$
		B port; $V_I$ or $V_O = 0\text{ V}$ to $3.6\text{ V}$ ; $V_{CC(B)} = 0\text{ V}$ ; $V_{CC(A)} = 0.8\text{ V}$ to $3.6\text{ V}$	-	$\pm 0.1$	$\pm 1$	$\mu\text{A}$
$C_I$	input capacitance	$\overline{OE}$ input; $V_I = 0\text{ V}$ or $3.3\text{ V}$ ; $V_{CC(A)} = V_{CC(B)} = 3.3\text{ V}$	-	2.0	-	pF
$C_{I/O}$	input/output capacitance	A and B port; $V_O = 3.3\text{ V}$ or $0\text{ V}$ ; $V_{CC(A)} = V_{CC(B)} = 3.3\text{ V}$	-	4.0	-	pF

[1]  $V_{CCO}$  is the supply voltage associated with the output port.

[2]  $V_{CCI}$  is the supply voltage associated with the data input port.

**Table 8. Static characteristics [1] [2]**

At recommended operating conditions; voltages are referenced to GND (ground = 0 V).

Symbol	Parameter	Conditions	-40 °C to +85 °C		-40 °C to +125 °C		Unit
			Min	Max	Min	Max	
$V_{IH}$	HIGH-level input voltage	data input					
		$V_{CCI} = 0.8\text{ V}$	$0.70V_{CCI}$	-	$0.70V_{CCI}$	-	V
		$V_{CCI} = 1.1\text{ V}$ to $1.95\text{ V}$	$0.65V_{CCI}$	-	$0.65V_{CCI}$	-	V
		$V_{CCI} = 2.3\text{ V}$ to $2.7\text{ V}$	1.6	-	1.6	-	V
		$V_{CCI} = 3.0\text{ V}$ to $3.6\text{ V}$	2	-	2	-	V
		$\overline{OE}$ input					
		$V_{CC(A)} = 0.8\text{ V}$	$0.70V_{CC(A)}$	-	$0.70V_{CC(A)}$	-	V
		$V_{CC(A)} = 1.1\text{ V}$ to $1.95\text{ V}$	$0.65V_{CC(A)}$	-	$0.65V_{CC(A)}$	-	V
		$V_{CC(A)} = 2.3\text{ V}$ to $2.7\text{ V}$	1.6	-	1.6	-	V
		$V_{CC(A)} = 3.0\text{ V}$ to $3.6\text{ V}$	2	-	2	-	V

Symbol	Parameter	Conditions	-40 °C to +85 °C		-40 °C to +125 °C		Unit
			Min	Max	Min	Max	
V <sub>IL</sub>	LOW-level input voltage	data input					
		V <sub>CCI</sub> = 0.8 V	-	0.30V <sub>CCI</sub>	-	0.30V <sub>CCI</sub>	V
		V <sub>CCI</sub> = 1.1 V to 1.95 V	-	0.35V <sub>CCI</sub>	-	0.35V <sub>CCI</sub>	V
		V <sub>CCI</sub> = 2.3 V to 2.7 V	-	0.7	-	0.7	V
		V <sub>CCI</sub> = 3.0 V to 3.6 V	-	0.8	-	0.8	V
		$\overline{\text{OE}}$ input					
		V <sub>CC(A)</sub> = 0.8 V	-	0.30V <sub>CC(A)</sub>	-	0.30V <sub>CC(A)</sub>	V
		V <sub>CC(A)</sub> = 1.1 V to 1.95 V	-	0.35V <sub>CC(A)</sub>	-	0.35V <sub>CC(A)</sub>	V
		V <sub>CC(A)</sub> = 2.3 V to 2.7 V	-	0.7	-	0.7	V
V <sub>CC(A)</sub> = 3.0 V to 3.6 V	-	0.8	-	0.8	V		
V <sub>OH</sub>	HIGH-level output voltage	V <sub>I</sub> = V <sub>IH</sub> or V <sub>IL</sub>					
		I <sub>O</sub> = -100 μA; V <sub>CC(A)</sub> = V <sub>CC(B)</sub> = 0.8 V to 3.6 V	V <sub>CCO</sub> - 0.1	-	V <sub>CCO</sub> - 0.1	-	V
		I <sub>O</sub> = -3 mA; V <sub>CC(A)</sub> = V <sub>CC(B)</sub> = 1.1 V	0.85	-	0.85	-	V
		I <sub>O</sub> = -6 mA; V <sub>CC(A)</sub> = V <sub>CC(B)</sub> = 1.4 V	1.05	-	1.05	-	V
		I <sub>O</sub> = -8 mA; V <sub>CC(A)</sub> = V <sub>CC(B)</sub> = 1.65 V	1.2	-	1.2	-	V
		I <sub>O</sub> = -9 mA; V <sub>CC(A)</sub> = V <sub>CC(B)</sub> = 2.3 V	1.75	-	1.75	-	V
		I <sub>O</sub> = -12 mA; V <sub>CC(A)</sub> = V <sub>CC(B)</sub> = 3.0 V	2.3	-	2.3	-	V
V <sub>OL</sub>	LOW-level output voltage	V <sub>I</sub> = V <sub>IH</sub> or V <sub>IL</sub>					
		I <sub>O</sub> = 100 μA; V <sub>CC(A)</sub> = V <sub>CC(B)</sub> = 0.8 V to 3.6 V	-	0.1	-	0.1	V
		I <sub>O</sub> = 3 mA; V <sub>CC(A)</sub> = V <sub>CC(B)</sub> = 1.1 V	-	0.25	-	0.25	V
		I <sub>O</sub> = 6 mA; V <sub>CC(A)</sub> = V <sub>CC(B)</sub> = 1.4 V	-	0.35	-	0.35	V
		I <sub>O</sub> = 8 mA; V <sub>CC(A)</sub> = V <sub>CC(B)</sub> = 1.65 V	-	0.45	-	0.45	V
		I <sub>O</sub> = 9 mA; V <sub>CC(A)</sub> = V <sub>CC(B)</sub> = 2.3 V	-	0.55	-	0.55	V
		I <sub>O</sub> = 12 mA; V <sub>CC(A)</sub> = V <sub>CC(B)</sub> = 3.0 V	-	0.7	-	0.7	V
I <sub>I</sub>	input leakage current	$\overline{\text{OE}}$ input; V <sub>I</sub> = 0 V or 3.6 V; V <sub>CC(A)</sub> = V <sub>CC(B)</sub> = 0.8 V to 3.6 V	-	±1	-	±5	μA
I <sub>OZ</sub>	OFF-state output current	A or B port; V <sub>O</sub> = 0 V or V <sub>CCO</sub> ; V <sub>CC(A)</sub> = V <sub>CC(B)</sub> = 3.6 V	-	±5	-	±30	μA
		suspend mode A port; V <sub>O</sub> = 0 V or V <sub>CCO</sub> ; V <sub>CC(A)</sub> = 3.6 V; V <sub>CC(B)</sub> = 0 V	-	±5	-	±30	μA
		suspend mode B port; V <sub>O</sub> = 0 V or V <sub>CCO</sub> ; V <sub>CC(A)</sub> = 0 V; V <sub>CC(B)</sub> = 3.6 V	-	±5	-	±30	μA

4-bit dual-supply buffer/level translator; 3-state

Symbol	Parameter	Conditions	-40 °C to +85 °C		-40 °C to +125 °C		Unit
			Min	Max	Min	Max	
I <sub>OFF</sub>	power-off leakage current	A port; V <sub>I</sub> or V <sub>O</sub> = 0 V to 3.6 V; V <sub>CC(A)</sub> = 0 V; V <sub>CC(B)</sub> = 0.8 V to 3.6 V	-	±5	-	±30	μA
		B port; V <sub>I</sub> or V <sub>O</sub> = 0 V to 3.6 V; V <sub>CC(B)</sub> = 0 V; V <sub>CC(A)</sub> = 0.8 V to 3.6 V	-	±5	-	±30	μA
I <sub>CC</sub>	supply current	A port; V <sub>I</sub> = 0 V or V <sub>CCI</sub> ; I <sub>O</sub> = 0 A					
		V <sub>CC(A)</sub> = 0.8 V to 3.6 V; V <sub>CC(B)</sub> = 0.8 V to 3.6 V	-	10	-	55	μA
		V <sub>CC(A)</sub> = 1.1 V to 3.6 V; V <sub>CC(B)</sub> = 1.1 V to 3.6 V	-	8	-	50	μA
		V <sub>CC(A)</sub> = 3.6 V; V <sub>CC(B)</sub> = 0 V	-	8	-	50	μA
		V <sub>CC(A)</sub> = 0 V; V <sub>CC(B)</sub> = 3.6 V	-2	-	-12	-	μA
		B port; V <sub>I</sub> = 0 V or V <sub>CCI</sub> ; I <sub>O</sub> = 0 A					
		V <sub>CC(A)</sub> = 0.8 V to 3.6 V; V <sub>CC(B)</sub> = 0.8 V to 3.6 V	-	10	-	55	μA
		V <sub>CC(A)</sub> = 1.1 V to 3.6 V; V <sub>CC(B)</sub> = 1.1 V to 3.6 V	-	8	-	50	μA
		V <sub>CC(A)</sub> = 3.6 V; V <sub>CC(B)</sub> = 0 V	-2	-	-12	-	μA
		V <sub>CC(A)</sub> = 0 V; V <sub>CC(B)</sub> = 3.6 V	-	8	-	50	μA
		A plus B port (I <sub>CC(A)</sub> + I <sub>CC(B)</sub> ); I <sub>O</sub> = 0 A; V <sub>I</sub> = 0 V or V <sub>CCI</sub> ; V <sub>CC(A)</sub> = 0.8 V to 3.6 V; V <sub>CC(B)</sub> = 0.8 V to 3.6 V	-	20	-	70	μA
		A plus B port (I <sub>CC(A)</sub> + I <sub>CC(B)</sub> ); I <sub>O</sub> = 0 A; V <sub>I</sub> = 0 V or V <sub>CCI</sub> ; V <sub>CC(A)</sub> = 1.1 V to 3.6 V; V <sub>CC(B)</sub> = 1.1 V to 3.6 V	-	16	-	65	μA
ΔI <sub>CC</sub>	additional supply current	V <sub>I</sub> = 3.0 V; V <sub>CC(A)</sub> = V <sub>CC(B)</sub> = 3.6 V	-	500	-	650	μA

- [1] V<sub>CCO</sub> is the supply voltage associated with the output port.
- [2] V<sub>CCI</sub> is the supply voltage associated with the data input port.

Table 9. Typical total supply current (I<sub>CC(A)</sub> + I<sub>CC(B)</sub>)

V <sub>CC(A)</sub>	V <sub>CC(B)</sub>							Unit
	0 V	0.8 V	1.2 V	1.5 V	1.8 V	2.5 V	3.3 V	
0 V	0	0.1	0.1	0.1	0.1	0.1	0.1	μA
0.8 V	0.1	0.1	0.1	0.1	0.1	0.3	1.6	μA
1.2 V	0.1	0.1	0.1	0.1	0.1	0.1	0.8	μA
1.5 V	0.1	0.1	0.1	0.1	0.1	0.1	0.4	μA
1.8 V	0.1	0.1	0.1	0.1	0.1	0.1	0.2	μA
2.5 V	0.1	0.3	0.1	0.1	0.1	0.1	0.1	μA
3.3 V	0.1	1.6	0.8	0.4	0.2	0.1	0.1	μA

## 11. Dynamic characteristics

**Table 10. Typical power dissipation capacitance at  $V_{CC(A)} = V_{CC(B)}$  and  $T_{amb} = 25\text{ °C}$  [1] [2]**

Voltages are referenced to GND (ground = 0 V).

Symbol	Parameter	Conditions	$V_{CC(A)} = V_{CC(B)}$						Unit
			0.8 V	1.2 V	1.5 V	1.8 V	2.5 V	3.3 V	
$C_{PD}$	power dissipation capacitance	inputs An, B4	0.2	0.2	0.2	0.2	0.3	0.5	pF
		outputs YBn, YA4	9.3	9.5	9.6	9.7	9.9	11.2	pF

[1]  $C_{PD}$  is used to determine the dynamic power dissipation ( $P_D$  in  $\mu\text{W}$ ).

$$P_D = C_{PD} \times V_{CC}^2 \times f_i \times N + \Sigma(C_L \times V_{CC}^2 \times f_o) \text{ where:}$$

$f_i$  = input frequency in MHz;

$f_o$  = output frequency in MHz;

$C_L$  = load capacitance in pF;

$V_{CC}$  = supply voltage in V;

$N$  = number of inputs switching;

$\Sigma(C_L \times V_{CC}^2 \times f_o)$  = sum of the outputs.

[2]  $f_i = 10\text{ MHz}$ ;  $V_i = \text{GND to } V_{CC}$ ;  $t_r = t_f = 1\text{ ns}$ ;  $C_L = 0\text{ pF}$ ;  $R_L = \infty\ \Omega$ .

**Table 11. Typical dynamic characteristics at  $V_{CC(A)} = 0.8\text{ V}$  and  $T_{amb} = 25\text{ °C}$  [1]**

Voltages are referenced to GND (ground = 0 V); for test circuit see Fig. 5; for wave forms see Fig. 3 and Fig. 4

Symbol	Parameter	Conditions	$V_{CC(B)}$						Unit
			0.8 V	1.2 V	1.5 V	1.8 V	2.5 V	3.3 V	
$t_{pd}$	propagation delay	An to YBn	14.5	7.3	6.5	6.2	5.9	6.0	ns
		B4 to YA4	14.5	12.7	12.4	12.3	12.1	12.0	ns
$t_{dis}$	disable time	$\overline{OE}$ to YBn	14.3	14.3	14.3	14.3	14.3	14.3	ns
		$\overline{OE}$ to YA4	17.0	9.9	9.0	9.4	9.0	9.7	ns
$t_{en}$	enable time	$\overline{OE}$ to YBn	18.2	18.2	18.2	18.2	18.2	18.2	ns
		$\overline{OE}$ to YA4	19.2	10.7	9.8	9.6	9.7	10.2	ns

[1]  $t_{pd}$  is the same as  $t_{PLH}$  and  $t_{PHL}$ ;  $t_{dis}$  is the same as  $t_{PLZ}$  and  $t_{PHZ}$ ;  $t_{en}$  is the same as  $t_{PZL}$  and  $t_{PZH}$ .

**Table 12. Typical dynamic characteristics at  $V_{CC(B)} = 0.8\text{ V}$  and  $T_{amb} = 25\text{ °C}$  [1]**

Voltages are referenced to GND (ground = 0 V); for test circuit see Fig. 5; for wave forms see Fig. 3 and Fig. 4

Symbol	Parameter	Conditions	$V_{CC(A)}$						Unit
			0.8 V	1.2 V	1.5 V	1.8 V	2.5 V	3.3 V	
$t_{pd}$	propagation delay	An to YBn	14.5	12.7	12.4	12.3	12.1	12.0	ns
		B4 to YA4	14.5	7.3	6.5	6.2	5.9	6.0	ns
$t_{dis}$	disable time	$\overline{OE}$ to YBn	14.3	5.5	4.1	4.0	3.0	3.5	ns
		$\overline{OE}$ to YA4	17.0	13.8	13.4	13.1	12.9	12.7	ns
$t_{en}$	enable time	$\overline{OE}$ to YBn	18.2	5.6	4.0	3.2	2.4	2.2	ns
		$\overline{OE}$ to YA4	19.2	14.6	14.1	13.9	13.7	13.6	ns

[1]  $t_{pd}$  is the same as  $t_{PLH}$  and  $t_{PHL}$ ;  $t_{dis}$  is the same as  $t_{PLZ}$  and  $t_{PHZ}$ ;  $t_{en}$  is the same as  $t_{PZL}$  and  $t_{PZH}$ .

Table 13. Dynamic characteristics for temperature range -40 °C to +85 °C [1]

Voltages are referenced to GND (ground = 0 V); for test circuit see Fig. 5; for wave forms see Fig. 3 and Fig. 4

Symbol	Parameter	Conditions	V <sub>CC(B)</sub>										Unit
			1.2 V ±0.1 V		1.5 V ±0.1 V		1.8 V ±0.15 V		2.5 V ±0.2 V		3.3 V ±0.3 V		
			Min	Max	Min	Max	Min	Max	Min	Max	Min	Max	
<b>V<sub>CC(A)</sub> = 1.1 V to 1.3 V</b>													
t <sub>pd</sub>	propagation delay	An to YBn	2.0	10.5	1.3	7.8	1.2	6.9	1.0	5.9	0.8	5.7	ns
		B4 to YA4	2.0	10.5	1.5	9.9	1.5	9.7	1.4	9.4	1.4	9.3	ns
t <sub>dis</sub>	disable time	$\overline{OE}$ to YBn	2.0	10.0	2.0	10.0	2.0	10.0	2.0	10.0	2.0	10.0	ns
		$\overline{OE}$ to YA4	2.0	11.1	2.0	8.6	1.0	8.0	0.7	7.0	1.0	8.0	ns
t <sub>en</sub>	enable time	$\overline{OE}$ to YBn	2.0	13.5	2.0	13.5	2.0	13.5	2.0	13.5	2.0	13.5	ns
		$\overline{OE}$ to YA4	2.0	15.0	2.0	11.0	2.0	9.4	1.0	7.8	1.0	7.4	ns
<b>V<sub>CC(A)</sub> = 1.4 V to 1.6 V</b>													
t <sub>pd</sub>	propagation delay	An to YBn	1.5	9.9	1.0	7.1	1.0	6.0	0.5	4.8	0.5	4.3	ns
		B4 to YA4	1.3	7.8	1.0	7.1	0.9	6.9	0.8	6.6	0.6	6.5	ns
t <sub>dis</sub>	disable time	$\overline{OE}$ to YBn	1.0	6.0	1.0	6.0	1.0	6.0	1.0	6.0	1.0	6.0	ns
		$\overline{OE}$ to YA4	2.0	10.2	1.5	7.5	0.9	7.2	0.4	6.2	0.4	6.1	ns
t <sub>en</sub>	enable time	$\overline{OE}$ to YBn	1.0	7.5	1.0	7.5	1.0	7.5	1.0	7.5	1.0	7.5	ns
		$\overline{OE}$ to YA4	2.0	14.4	1.4	7.9	1.3	7.7	1.1	6.4	1.1	5.6	ns
<b>V<sub>CC(A)</sub> = 1.65 V to 1.95 V</b>													
t <sub>pd</sub>	propagation delay	An to YBn	1.5	9.7	0.9	6.9	0.8	5.7	0.5	4.5	0.3	4.0	ns
		B4 to YA4	1.2	6.9	1.0	6.0	0.8	5.7	0.5	5.5	0.5	5.3	ns
t <sub>dis</sub>	disable time	$\overline{OE}$ to YBn	0.5	5.7	0.5	5.7	0.5	5.7	0.5	5.7	0.5	5.7	ns
		$\overline{OE}$ to YA4	2.0	9.9	1.5	7.0	0.8	6.9	0.2	5.8	0.2	5.9	ns
t <sub>en</sub>	enable time	$\overline{OE}$ to YBn	1.0	6.7	1.0	6.7	1.0	6.7	1.0	6.7	1.0	6.7	ns
		$\overline{OE}$ to YA4	1.5	13.9	1.2	7.2	1.2	6.9	0.8	5.4	0.6	5.0	ns
<b>V<sub>CC(A)</sub> = 2.3 V to 2.7 V</b>													
t <sub>pd</sub>	propagation delay	An to YBn	1.4	9.4	0.8	6.6	0.5	5.5	0.4	4.2	0.2	3.7	ns
		B4 to YA4	1.0	5.9	0.5	4.8	0.5	4.5	0.4	4.2	0.3	3.9	ns
t <sub>dis</sub>	disable time	$\overline{OE}$ to YBn	0.2	4.0	0.2	4.0	0.2	4.0	0.2	4.0	0.2	4.0	ns
		$\overline{OE}$ to YA4	2.0	9.3	1.5	6.7	0.7	6.3	0.2	5.0	0.2	5.7	ns
t <sub>en</sub>	enable time	$\overline{OE}$ to YBn	0.6	4.5	0.6	4.5	0.6	4.5	0.6	4.5	0.6	4.5	ns
		$\overline{OE}$ to YA4	1.5	13.6	1.0	6.8	1.0	6.0	0.8	4.6	0.6	4.2	ns
<b>V<sub>CC(A)</sub> = 3.0 V to 3.6 V</b>													
t <sub>pd</sub>	propagation delay	An to YBn	1.4	9.3	0.6	6.5	0.5	5.3	0.3	3.9	0.2	3.5	ns
		B4 to YA4	0.8	5.7	0.5	4.3	0.3	4.0	0.2	3.7	0.2	3.5	ns
t <sub>dis</sub>	disable time	$\overline{OE}$ to YBn	0.2	4.5	0.2	4.5	0.2	4.5	0.2	4.5	0.2	4.5	ns
		$\overline{OE}$ to YA4	2.0	9.0	1.5	6.4	0.7	6.1	0.2	4.8	0.2	5.6	ns
t <sub>en</sub>	enable time	$\overline{OE}$ to YBn	0.5	4.0	0.5	4.0	0.5	4.0	0.5	4.0	0.5	4.0	ns
		$\overline{OE}$ to YA4	1.5	13.4	1.0	6.7	1.0	5.9	0.7	4.4	0.5	4.0	ns

[1] t<sub>pd</sub> is the same as t<sub>PLH</sub> and t<sub>PHL</sub>; t<sub>dis</sub> is the same as t<sub>PLZ</sub> and t<sub>PHZ</sub>; t<sub>en</sub> is the same as t<sub>PZL</sub> and t<sub>PZH</sub>.

Table 14. Dynamic characteristics for temperature range -40 °C to +125 °C [1]

Voltages are referenced to GND (ground = 0 V); for test circuit see Fig. 5; for wave forms see Fig. 3 and Fig. 4

Symbol	Parameter	Conditions	V <sub>CC(B)</sub>										Unit
			1.2 V ±0.1 V		1.5 V ±0.1 V		1.8 V ±0.15 V		2.5 V ±0.2 V		3.3 V ±0.3 V		
			Min	Max	Min	Max	Min	Max	Min	Max	Min	Max	
<b>V<sub>CC(A)</sub> = 1.1 V to 1.3 V</b>													
t <sub>pd</sub>	propagation delay	An to YBn	2.0	12.1	1.3	9.0	1.2	8.0	1.0	6.8	0.8	6.6	ns
		B4 to YA4	2.0	12.1	1.5	11.4	1.5	11.2	1.4	10.9	1.4	10.7	ns
t <sub>dis</sub>	disable time	$\overline{OE}$ to YBn	2.0	11.5	2.0	11.5	2.0	11.5	2.0	11.5	2.0	11.5	ns
		$\overline{OE}$ to YA4	2.0	12.8	2.0	9.9	1.0	9.2	0.7	8.1	1.0	9.2	ns
t <sub>en</sub>	enable time	$\overline{OE}$ to YBn	2.0	15.6	2.0	15.6	2.0	15.6	2.0	15.6	2.0	15.6	ns
		$\overline{OE}$ to YA4	2.0	17.3	2.0	12.7	2.0	10.9	1.0	9.0	1.0	8.6	ns
<b>V<sub>CC(A)</sub> = 1.4 V to 1.6 V</b>													
t <sub>pd</sub>	propagation delay	An to YBn	1.5	11.4	1.0	8.2	1.0	6.9	0.5	5.6	0.5	5.0	ns
		B4 to YA4	1.3	9.0	1.0	8.2	0.9	8.0	0.8	7.6	0.6	7.5	ns
t <sub>dis</sub>	disable time	$\overline{OE}$ to YBn	1.0	6.9	1.0	6.9	1.0	6.9	1.0	6.9	1.0	6.9	ns
		$\overline{OE}$ to YA4	2.0	11.8	1.5	8.7	0.9	8.3	0.4	7.2	0.4	7.1	ns
t <sub>en</sub>	enable time	$\overline{OE}$ to YBn	1.0	8.7	1.0	8.7	1.0	8.7	1.0	8.7	1.0	8.7	ns
		$\overline{OE}$ to YA4	2.0	16.6	1.4	9.1	1.3	8.9	1.1	7.4	1.1	6.5	ns
<b>V<sub>CC(A)</sub> = 1.65 V to 1.95 V</b>													
t <sub>pd</sub>	propagation delay	An to YBn	1.5	11.2	0.9	8.0	0.8	6.6	0.5	5.2	0.3	4.6	ns
		B4 to YA4	1.2	8.0	1.0	6.9	0.8	6.6	0.5	6.4	0.5	6.1	ns
t <sub>dis</sub>	disable time	$\overline{OE}$ to YBn	0.5	6.6	0.5	6.6	0.5	6.6	0.5	6.6	0.5	6.6	ns
		$\overline{OE}$ to YA4	2.0	11.4	1.5	8.1	0.8	8.0	0.2	6.7	0.2	6.8	ns
t <sub>en</sub>	enable time	$\overline{OE}$ to YBn	1.0	7.8	1.0	7.8	1.0	7.8	1.0	7.8	1.0	7.8	ns
		$\overline{OE}$ to YA4	1.5	16.0	1.2	8.3	1.2	8.0	0.8	6.3	0.6	5.8	ns
<b>V<sub>CC(A)</sub> = 2.3 V to 2.7 V</b>													
t <sub>pd</sub>	propagation delay	An to YBn	1.4	10.9	0.8	7.6	0.5	6.4	0.4	4.9	0.2	4.3	ns
		B4 to YA4	1.0	6.8	0.5	5.6	0.5	5.2	0.4	4.9	0.3	4.5	ns
t <sub>dis</sub>	disable time	$\overline{OE}$ to YBn	0.2	4.6	0.2	4.6	0.2	4.6	0.2	4.6	0.2	4.6	ns
		$\overline{OE}$ to YA4	2.0	10.7	1.5	7.8	0.7	7.3	0.2	5.8	0.2	6.6	ns
t <sub>en</sub>	enable time	$\overline{OE}$ to YBn	0.6	5.2	0.6	5.2	0.6	5.2	0.6	5.2	0.6	5.2	ns
		$\overline{OE}$ to YA4	1.5	15.7	1.0	7.9	1.0	6.9	0.8	5.3	0.6	4.9	ns
<b>V<sub>CC(A)</sub> = 3.0 V to 3.6 V</b>													
t <sub>pd</sub>	propagation delay	An to YBn	1.4	10.7	0.6	7.5	0.5	6.1	0.3	4.5	0.2	4.1	ns
		B4 to YA4	0.8	6.6	0.5	5.0	0.3	4.6	0.2	4.3	0.2	4.1	ns
t <sub>dis</sub>	disable time	$\overline{OE}$ to YBn	0.2	5.2	0.2	5.2	0.2	5.2	0.2	5.2	0.2	5.2	ns
		$\overline{OE}$ to YA4	2.0	10.4	1.5	7.4	0.7	7.1	0.2	5.6	0.2	6.5	ns
t <sub>en</sub>	enable time	$\overline{OE}$ to YBn	0.5	4.6	0.5	4.6	0.5	4.6	0.5	4.6	0.5	4.6	ns
		$\overline{OE}$ to YA4	1.5	15.5	1.0	7.8	1.0	6.8	0.7	5.1	0.5	4.6	ns

[1] t<sub>pd</sub> is the same as t<sub>PLH</sub> and t<sub>PHL</sub>; t<sub>dis</sub> is the same as t<sub>PLZ</sub> and t<sub>PHZ</sub>; t<sub>en</sub> is the same as t<sub>PZL</sub> and t<sub>PZH</sub>.

11.1. Waveforms and test circuit

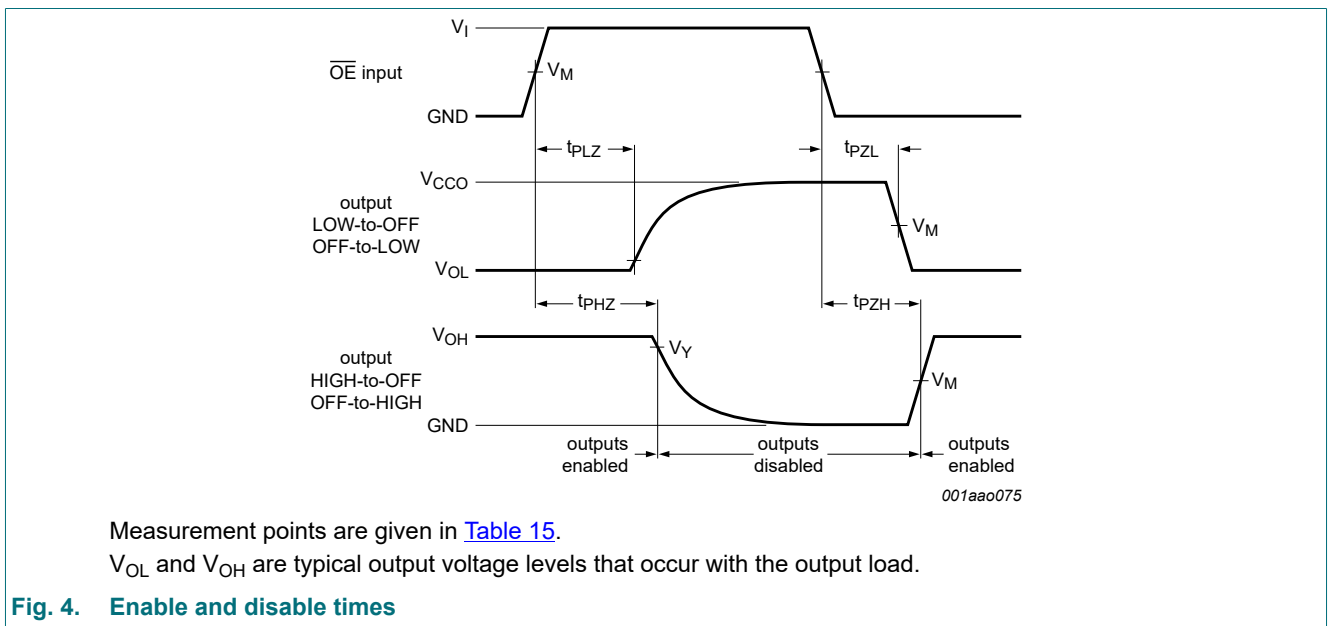
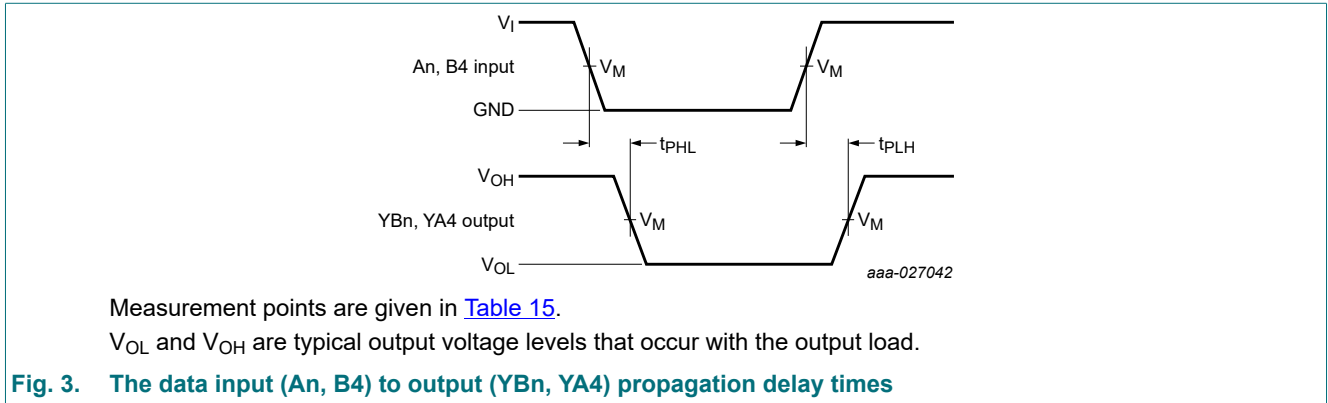
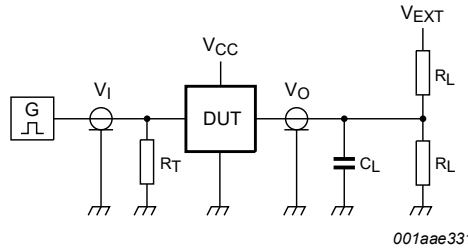
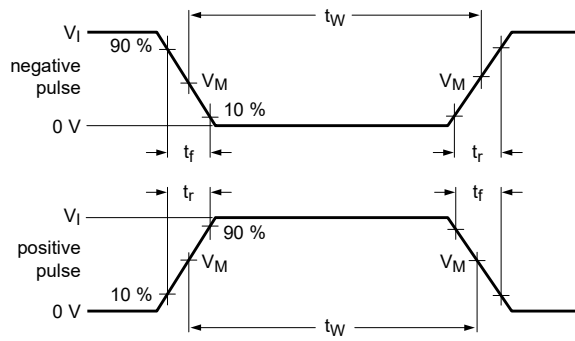

Table 15. Measurement points

Supply voltage	Input [1]	Output [2]		
$V_{CC(A)}, V_{CC(B)}$	$V_M$	$V_M$	$V_X$	$V_Y$
0.8 V to 1.6 V	$0.5V_{CCI}$	$0.5V_{CCO}$	$V_{OL} + 0.1\text{ V}$	$V_{OH} - 0.1\text{ V}$
1.65 V to 2.7 V	$0.5V_{CCI}$	$0.5V_{CCO}$	$V_{OL} + 0.15\text{ V}$	$V_{OH} - 0.15\text{ V}$
3.0 V to 3.6 V	$0.5V_{CCI}$	$0.5V_{CCO}$	$V_{OL} + 0.3\text{ V}$	$V_{OH} - 0.3\text{ V}$

[1]  $V_{CCI}$  is the supply voltage associated with the data input port.

[2]  $V_{CCO}$  is the supply voltage associated with the output port.



001aae331

Test data is given in [Table 16](#) .

Definitions test circuit:

$R_L$  = Load resistance;

$C_L$  = Load capacitance including jig and probe capacitance;

$R_T$  = Termination resistance;

$V_{EXT}$  = External voltage for measuring switching times.

**Fig. 5. Test circuit for measuring switching times**

**Table 16. Test data**

Supply voltage	Input		Load		$V_{EXT}$		
$V_{CC(A)}, V_{CC(B)}$	$V_I$ [1]	$\Delta t/\Delta V$ [2]	$C_L$	$R_L$	$t_{PLH}, t_{PHL}$	$t_{PZH}, t_{PHZ}$	$t_{PZL}, t_{PLZ}$ [3]
0.8 V to 1.6 V	$V_{CCI}$	$\leq 1.0$ ns/V	15 pF	2 k $\Omega$	open	GND	$2V_{CCO}$
1.65 V to 2.7 V	$V_{CCI}$	$\leq 1.0$ ns/V	15 pF	2 k $\Omega$	open	GND	$2V_{CCO}$
3.0 V to 3.6 V	$V_{CCI}$	$\leq 1.0$ ns/V	15 pF	2 k $\Omega$	open	GND	$2V_{CCO}$

[1]  $V_{CCI}$  is the supply voltage associated with the data input port.

[2]  $dV/dt \geq 1.0$  V/ns

[3]  $V_{CCO}$  is the supply voltage associated with the output port.

11.2. Typical propagation delay characteristics

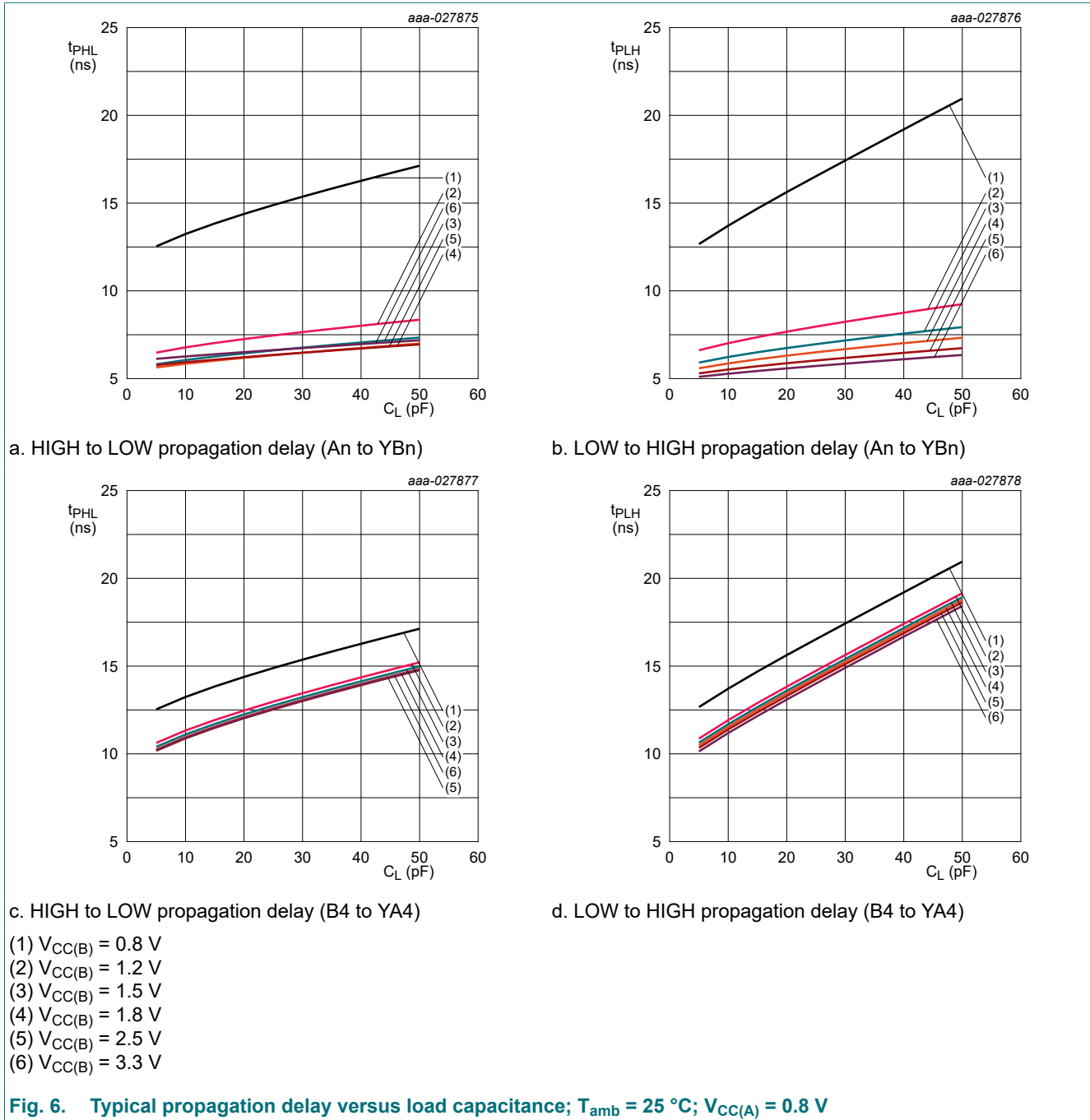

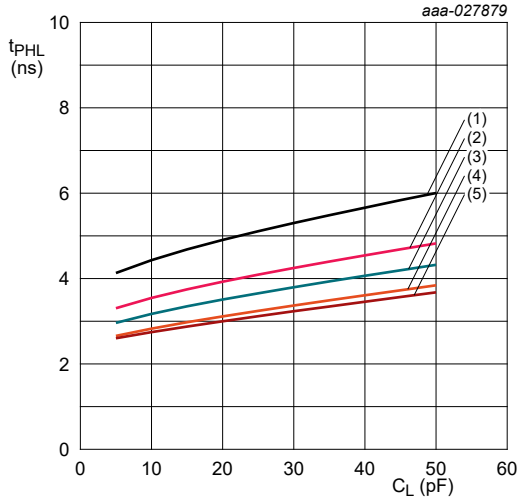

a. HIGH to LOW propagation delay (An to YBn)

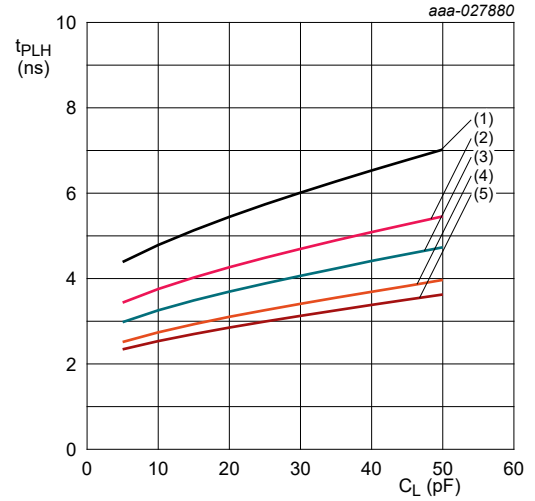

b. LOW to HIGH propagation delay (An to YBn)

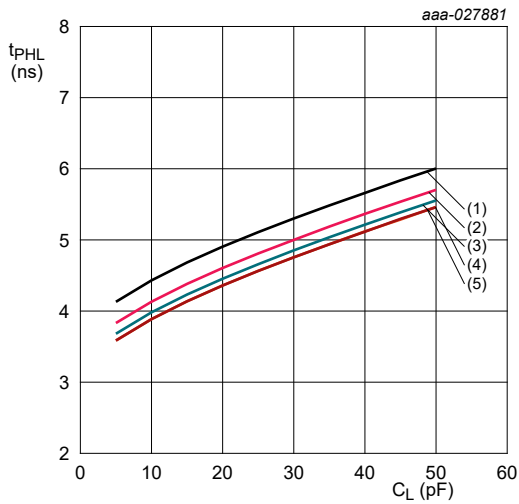

c. HIGH to LOW propagation delay (B4 to YA4)

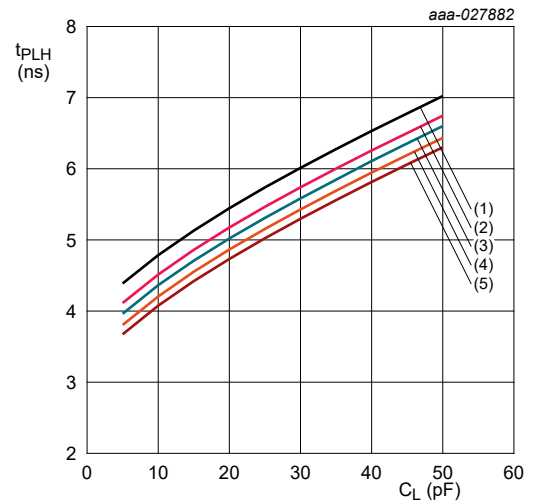

d. LOW to HIGH propagation delay (B4 to YA4)

- (1)  $V_{CC(B)} = 1.2\text{ V}$
- (2)  $V_{CC(B)} = 1.5\text{ V}$
- (3)  $V_{CC(B)} = 1.8\text{ V}$
- (4)  $V_{CC(B)} = 2.5\text{ V}$
- (5)  $V_{CC(B)} = 3.3\text{ V}$

Fig. 7. Typical propagation delay versus load capacitance;  $T_{amb} = 25\text{ }^\circ\text{C}$ ;  $V_{CC(A)} = 1.2\text{ V}$

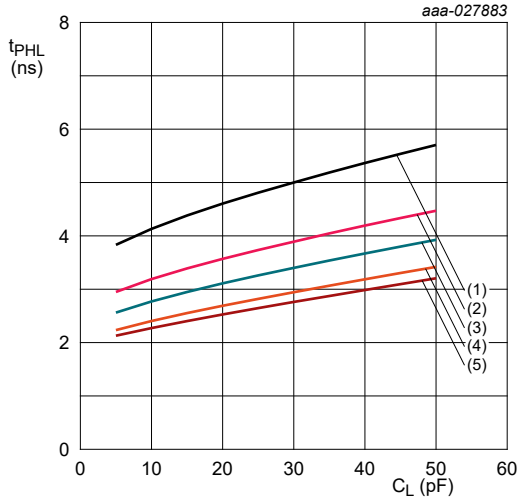

a. HIGH to LOW propagation delay (An to YBn)

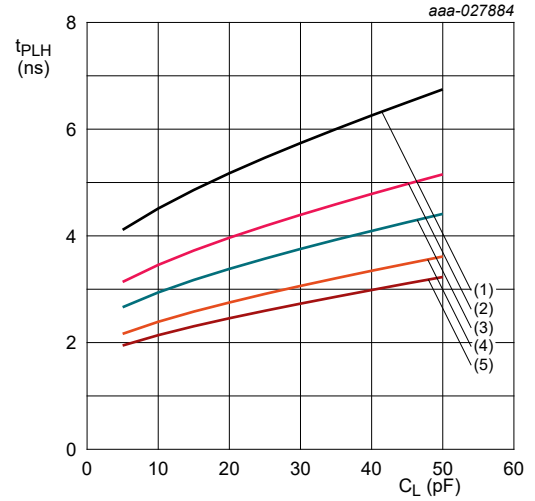

b. LOW to HIGH propagation delay (An to YBn)

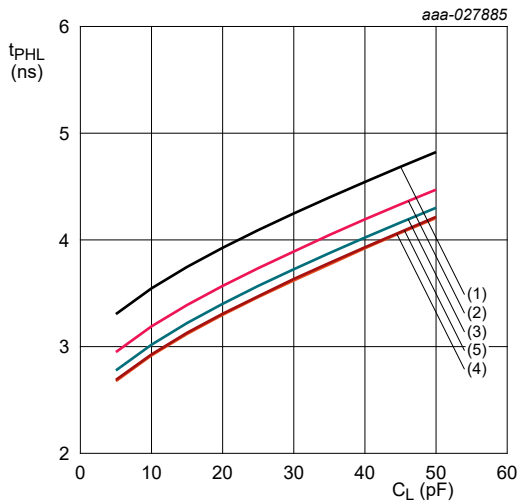

c. HIGH to LOW propagation delay (B4 to YA4)

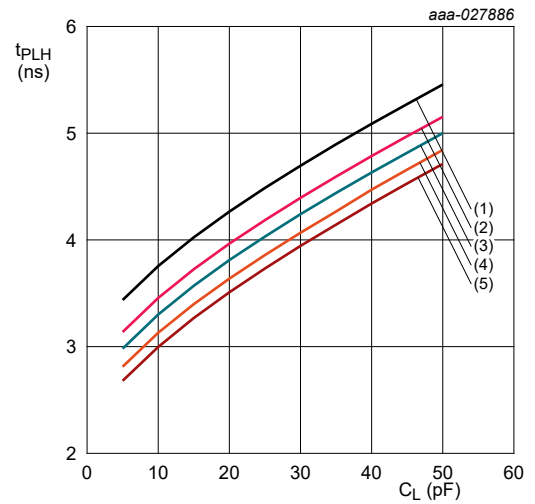

d. LOW to HIGH propagation delay (B4 to YA4)

- (1)  $V_{CC(B)} = 1.2\text{ V}$
- (2)  $V_{CC(B)} = 1.5\text{ V}$
- (3)  $V_{CC(B)} = 1.8\text{ V}$
- (4)  $V_{CC(B)} = 2.5\text{ V}$
- (5)  $V_{CC(B)} = 3.3\text{ V}$

Fig. 8. Typical propagation delay versus load capacitance;  $T_{amb} = 25\text{ }^\circ\text{C}$ ;  $V_{CC(A)} = 1.5\text{ V}$

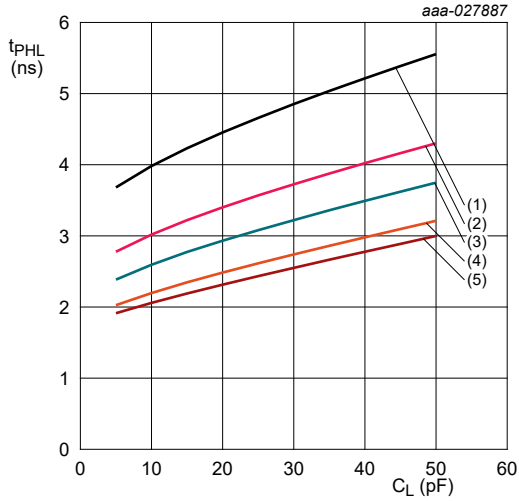

a. HIGH to LOW propagation delay (An to YBn)

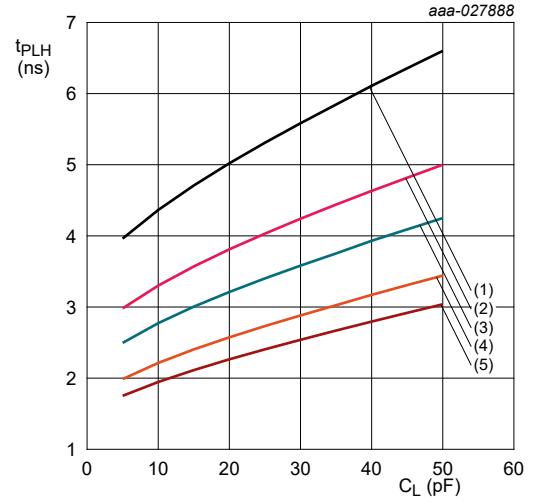

b. LOW to HIGH propagation delay (An to YBn)

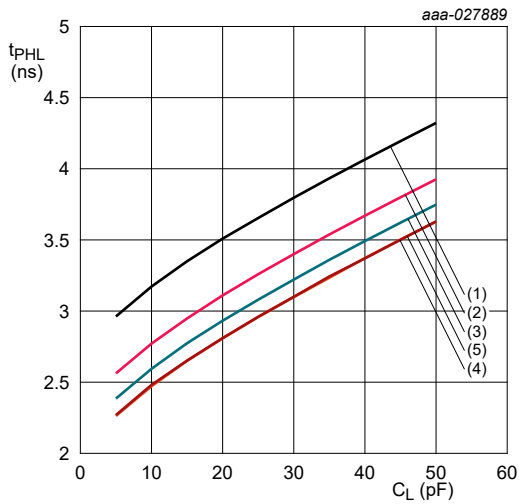

c. HIGH to LOW propagation delay (B4 to YA4)

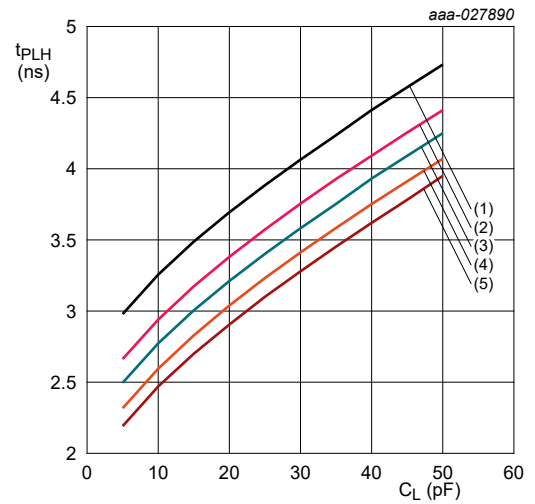

d. LOW to HIGH propagation delay (B4 to YA4)

- (1)  $V_{CC(B)} = 1.2\text{ V}$
- (2)  $V_{CC(B)} = 1.5\text{ V}$
- (3)  $V_{CC(B)} = 1.8\text{ V}$
- (4)  $V_{CC(B)} = 2.5\text{ V}$
- (5)  $V_{CC(B)} = 3.3\text{ V}$

Fig. 9. Typical propagation delay versus load capacitance;  $T_{amb} = 25\text{ }^\circ\text{C}$ ;  $V_{CC(A)} = 1.8\text{ V}$

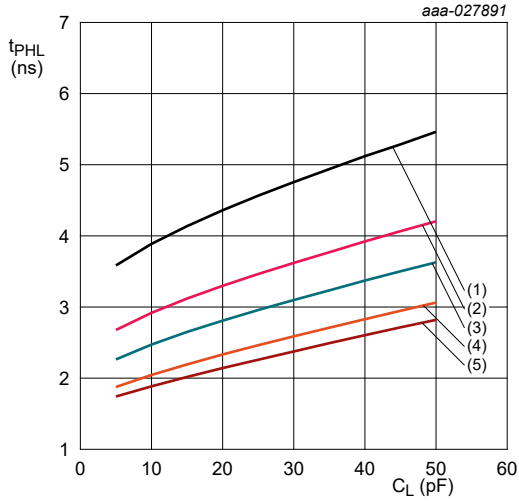

a. HIGH to LOW propagation delay (An to YBn)

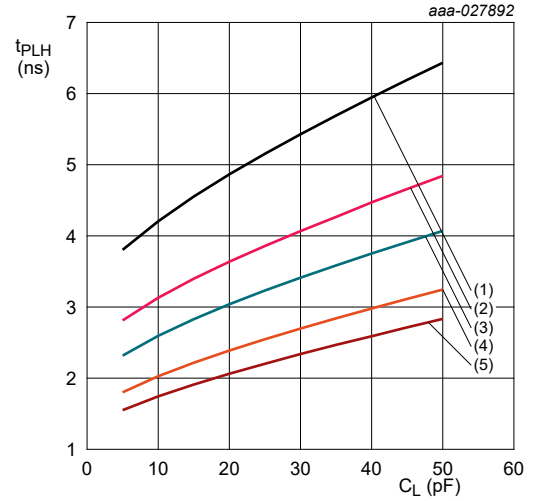

b. LOW to HIGH propagation delay (An to YBn)

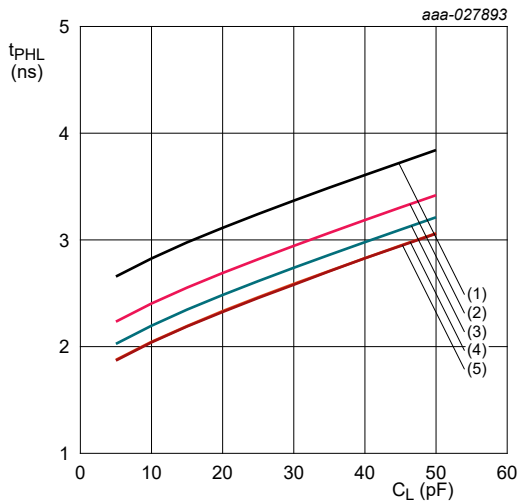

c. HIGH to LOW propagation delay (B4 to YA4)

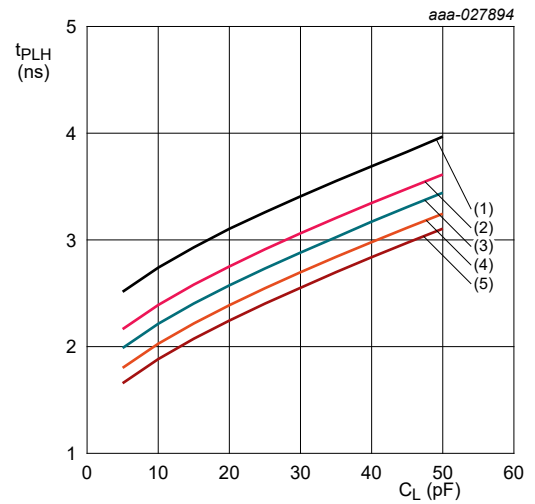

d. LOW to HIGH propagation delay (B4 to YA4)

- (1)  $V_{CC(B)} = 1.2\text{ V}$
- (2)  $V_{CC(B)} = 1.5\text{ V}$
- (3)  $V_{CC(B)} = 1.8\text{ V}$
- (4)  $V_{CC(B)} = 2.5\text{ V}$
- (5)  $V_{CC(B)} = 3.3\text{ V}$

Fig. 10. Typical propagation delay versus load capacitance;  $T_{amb} = 25\text{ }^\circ\text{C}$ ;  $V_{CC(A)} = 2.5\text{ V}$

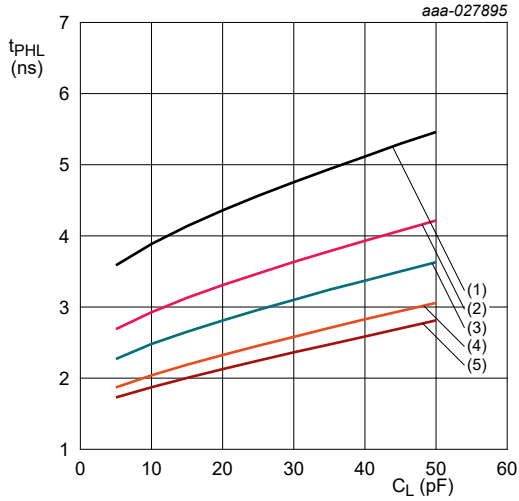

a. HIGH to LOW propagation delay (An to YBn)

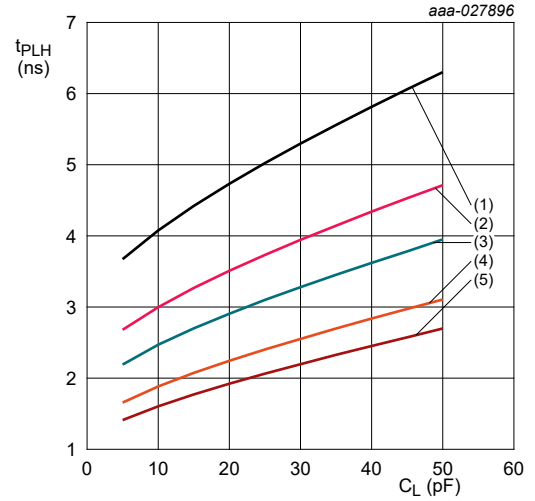

b. LOW to HIGH propagation delay (An to YBn)

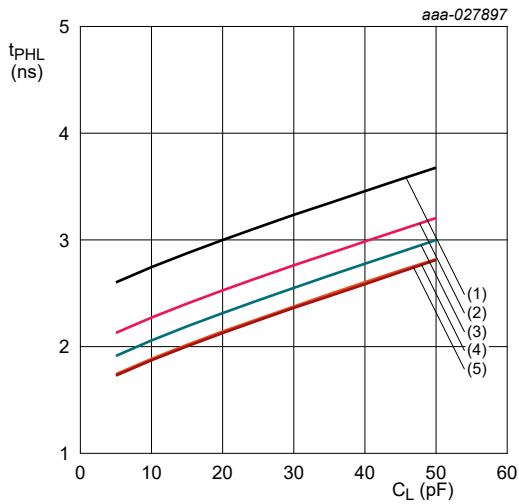

c. HIGH to LOW propagation delay (B4 to YA4)

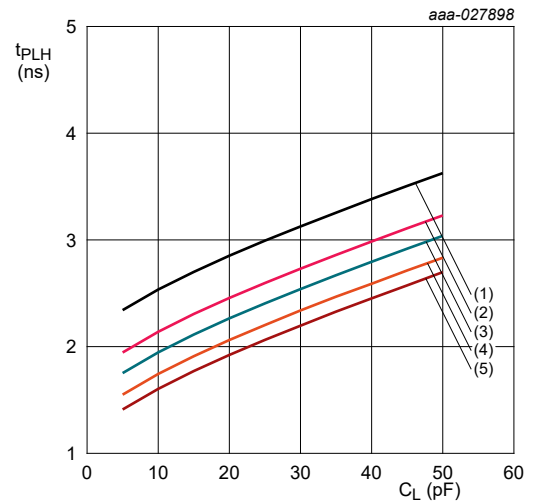

d. LOW to HIGH propagation delay (B4 to YA4)

- (1)  $V_{CC(B)} = 1.2\text{ V}$
- (2)  $V_{CC(B)} = 1.5\text{ V}$
- (3)  $V_{CC(B)} = 1.8\text{ V}$
- (4)  $V_{CC(B)} = 2.5\text{ V}$
- (5)  $V_{CC(B)} = 3.3\text{ V}$

Fig. 11. Typical propagation delay versus load capacitance;  $T_{amb} = 25\text{ }^\circ\text{C}$ ;  $V_{CC(A)} = 3.3\text{ V}$

## 12. Package outline

**XQFN12: plastic, extremely thin quad flat package; no leads; 12 terminals; body 1.70 x 2.00 x 0.50 mm**

SOT1174-1

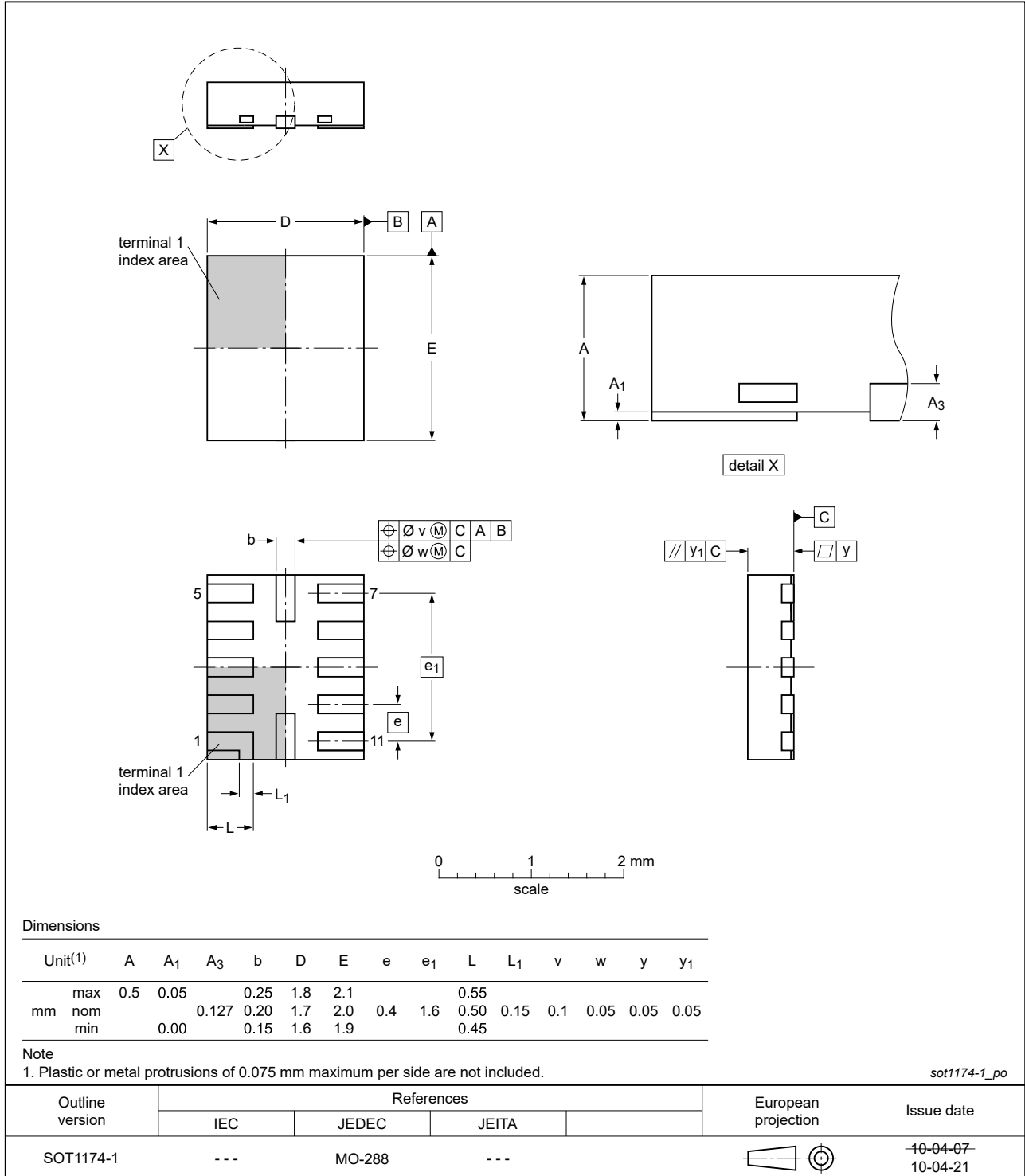

Fig. 12. Package outline SOT1174-1 (XQFN12)

## 13. Abbreviations

Table 17. Abbreviations

Acronym	Description
ANSI	American National Standards Institute
CDM	Charged Device Model
CMOS	Complementary Metal Oxide Semiconductor
DUT	Device Under Test
ESD	ElectroStatic Discharge
ESDA	ElectroStatic Discharge Association
HBM	Human Body Model
JEDEC	Joint Electron Device Engineering Council

## 14. Revision history

Table 18. Revision history

Document ID	Release date	Data sheet status	Change notice	Supersedes
74AVC4T3144 v.3	20240702	Product data sheet	-	74AVC4T3144 v.2
Modifications:	<ul style="list-style-type: none"> <li><a href="#">Section 2</a>: ESD specification updated according to the latest JEDEC standard.</li> </ul>			
74AVC4T3144 v.2	20180724	Product data sheet	-	74AVC4T3144 v.1
Modifications:	<ul style="list-style-type: none"> <li><a href="#">Table 3</a>: pin number corrected for GND pin.</li> </ul>			
74AVC4T3144 v.1	20171218	Product data sheet	-	-

## 15. Legal information

### Data sheet status

Document status [1][2]	Product status [3]	Definition
Objective [short] data sheet	Development	This document contains data from the objective specification for product development.
Preliminary [short] data sheet	Qualification	This document contains data from the preliminary specification.
Product [short] data sheet	Production	This document contains the product specification.

- [1] Please consult the most recently issued document before initiating or completing a design.
- [2] The term 'short data sheet' is explained in section "Definitions".
- [3] The product status of device(s) described in this document may have changed since this document was published and may differ in case of multiple devices. The latest product status information is available on the internet at <https://www.nexperia.com>.

### Definitions

**Draft** — The document is a draft version only. The content is still under internal review and subject to formal approval, which may result in modifications or additions. Nexperia does not give any representations or warranties as to the accuracy or completeness of information included herein and shall have no liability for the consequences of use of such information.

**Short data sheet** — A short data sheet is an extract from a full data sheet with the same product type number(s) and title. A short data sheet is intended for quick reference only and should not be relied upon to contain detailed and full information. For detailed and full information see the relevant full data sheet, which is available on request via the local Nexperia sales office. In case of any inconsistency or conflict with the short data sheet, the full data sheet shall prevail.

**Product specification** — The information and data provided in a Product data sheet shall define the specification of the product as agreed between Nexperia and its customer, unless Nexperia and customer have explicitly agreed otherwise in writing. In no event however, shall an agreement be valid in which the Nexperia product is deemed to offer functions and qualities beyond those described in the Product data sheet.

### Disclaimers

**Limited warranty and liability** — Information in this document is believed to be accurate and reliable. However, Nexperia does not give any representations or warranties, expressed or implied, as to the accuracy or completeness of such information and shall have no liability for the consequences of use of such information. Nexperia takes no responsibility for the content in this document if provided by an information source outside of Nexperia.

In no event shall Nexperia be liable for any indirect, incidental, punitive, special or consequential damages (including - without limitation - lost profits, lost savings, business interruption, costs related to the removal or replacement of any products or rework charges) whether or not such damages are based on tort (including negligence), warranty, breach of contract or any other legal theory.

Notwithstanding any damages that customer might incur for any reason whatsoever, Nexperia's aggregate and cumulative liability towards customer for the products described herein shall be limited in accordance with the Terms and conditions of commercial sale of Nexperia.

**Right to make changes** — Nexperia reserves the right to make changes to information published in this document, including without limitation specifications and product descriptions, at any time and without notice. This document supersedes and replaces all information supplied prior to the publication hereof.

**Suitability for use** — Nexperia products are not designed, authorized or warranted to be suitable for use in life support, life-critical or safety-critical systems or equipment, nor in applications where failure or malfunction of an Nexperia product can reasonably be expected to result in personal

injury, death or severe property or environmental damage. Nexperia and its suppliers accept no liability for inclusion and/or use of Nexperia products in such equipment or applications and therefore such inclusion and/or use is at the customer's own risk.

**Quick reference data** — The Quick reference data is an extract of the product data given in the Limiting values and Characteristics sections of this document, and as such is not complete, exhaustive or legally binding.

**Applications** — Applications that are described herein for any of these products are for illustrative purposes only. Nexperia makes no representation or warranty that such applications will be suitable for the specified use without further testing or modification.

Customers are responsible for the design and operation of their applications and products using Nexperia products, and Nexperia accepts no liability for any assistance with applications or customer product design. It is customer's sole responsibility to determine whether the Nexperia product is suitable and fit for the customer's applications and products planned, as well as for the planned application and use of customer's third party customer(s). Customers should provide appropriate design and operating safeguards to minimize the risks associated with their applications and products.

Nexperia does not accept any liability related to any default, damage, costs or problem which is based on any weakness or default in the customer's applications or products, or the application or use by customer's third party customer(s). Customer is responsible for doing all necessary testing for the customer's applications and products using Nexperia products in order to avoid a default of the applications and the products or of the application or use by customer's third party customer(s). Nexperia does not accept any liability in this respect.

**Limiting values** — Stress above one or more limiting values (as defined in the Absolute Maximum Ratings System of IEC 60134) will cause permanent damage to the device. Limiting values are stress ratings only and (proper) operation of the device at these or any other conditions above those given in the Recommended operating conditions section (if present) or the Characteristics sections of this document is not warranted. Constant or repeated exposure to limiting values will permanently and irreversibly affect the quality and reliability of the device.

**Terms and conditions of commercial sale** — Nexperia products are sold subject to the general terms and conditions of commercial sale, as published at <http://www.nexperia.com/profile/terms>, unless otherwise agreed in a valid written individual agreement. In case an individual agreement is concluded only the terms and conditions of the respective agreement shall apply. Nexperia hereby expressly objects to applying the customer's general terms and conditions with regard to the purchase of Nexperia products by customer.

**No offer to sell or license** — Nothing in this document may be interpreted or construed as an offer to sell products that is open for acceptance or the grant, conveyance or implication of any license under any copyrights, patents or other industrial or intellectual property rights.

**Export control** — This document as well as the item(s) described herein may be subject to export control regulations. Export might require a prior authorization from competent authorities.

**Non-automotive qualified products** — Unless this data sheet expressly states that this specific Nexperia product is automotive qualified, the product is not suitable for automotive use. It is neither qualified nor tested in accordance with automotive testing or application requirements. Nexperia accepts no liability for inclusion and/or use of non-automotive qualified products in automotive equipment or applications.

In the event that customer uses the product for design-in and use in automotive applications to automotive specifications and standards, customer (a) shall use the product without Nexperia's warranty of the product for such automotive applications, use and specifications, and (b) whenever customer uses the product for automotive applications beyond Nexperia's specifications such use shall be solely at customer's own risk, and (c) customer fully indemnifies Nexperia for any liability, damages or failed product claims resulting from customer design and use of the product for automotive applications beyond Nexperia's standard warranty and Nexperia's product specifications.

**Translations** — A non-English (translated) version of a document is for reference only. The English version shall prevail in case of any discrepancy between the translated and English versions.

### Trademarks

Notice: All referenced brands, product names, service names and trademarks are the property of their respective owners.

## Contents

<b>1. General description</b> .....	<b>1</b>
<b>2. Features and benefits</b> .....	<b>1</b>
<b>3. Ordering information</b> .....	<b>2</b>
<b>4. Marking</b> .....	<b>2</b>
<b>5. Functional diagram</b> .....	<b>2</b>
<b>6. Pinning information</b> .....	<b>3</b>
6.1. Pinning.....	3
6.2. Pin description.....	3
<b>7. Functional description</b> .....	<b>3</b>
<b>8. Limiting values</b> .....	<b>4</b>
<b>9. Recommended operating conditions</b> .....	<b>4</b>
<b>10. Static characteristics</b> .....	<b>5</b>
<b>11. Dynamic characteristics</b> .....	<b>8</b>
11.1. Waveforms and test circuit.....	11
11.2. Typical propagation delay characteristics.....	13
<b>12. Package outline</b> .....	<b>19</b>
<b>13. Abbreviations</b> .....	<b>20</b>
<b>14. Revision history</b> .....	<b>20</b>
<b>15. Legal information</b> .....	<b>21</b>

© Nexperia B.V. 2024. All rights reserved



For more information, please visit: <http://www.nexperia.com>

For sales office addresses, please send an email to: [salesaddresses@nexperia.com](mailto:salesaddresses@nexperia.com)

Date of release: 2 July 2024

## Looking for pricing, stock, or lifecycle information?

Click below to explore more details on WIN SOURCE:

-  [View 74AVC4T3144GU12X on WIN SOURCE](#)
-  [Nexperia USA Inc. Information](#)

## Optimize Your Supply Chain with WIN SOURCE Solutions

-  Global Sourcing Solution
-  Obsolete Management
-  Cost Control Management
-  Shortage Management
-  Alternative Solution
-  Excess Inventory Management