



# THE DATASHEET OF CMDSH-3 TR



**CMDSH-3**  
**SURFACE MOUNT SILICON**  
**SCHOTTKY DIODE**



[www.centrasemi.com](http://www.centrasemi.com)

**DESCRIPTION:**

The CENTRAL SEMICONDUCTOR CMDSH-3 is a silicon Schottky diode, manufactured in an SOD-323 surface mount package, designed for fast switching applications requiring a low forward voltage drop.



**SOD-323 CASE**

**MARKING CODE: S1**

**MAXIMUM RATINGS:** ( $T_A=25^\circ\text{C}$  unless otherwise noted)

	SYMBOL		UNITS
Peak Repetitive Reverse Voltage	$V_{RRM}$	30	V
Average Forward Current	$I_O$	100	mA
Peak Forward Surge Current, $t_p=10\text{ms}$	$I_{FSM}$	750	mA
Power Dissipation	$P_D$	250	mW
Power Dissipation ( $T_L=25^\circ\text{C}$ )	$P_D$	833	mW
Operating and Storage Junction Temperature	$T_J, T_{stg}$	-65 to +150	$^\circ\text{C}$
Thermal Resistance	$\theta_{JA}$	500	$^\circ\text{C/W}$
Thermal Resistance	$\theta_{JL}$	150	$^\circ\text{C/W}$

**ELECTRICAL CHARACTERISTICS:** ( $T_A=25^\circ\text{C}$ )

SYMBOL	TEST CONDITIONS	MIN	TYP	MAX	UNITS
$I_R$	$V_R=25\text{V}$			1.0	$\mu\text{A}$
$BV_R$	$I_F=100\mu\text{A}$	30			V
$V_F$	$I_F=2.0\text{mA}$		0.29		V
$V_F$	$I_F=15\text{mA}$		0.37		V
$V_F$	$I_F=50\text{mA}$		0.44	0.55	V
$V_F$	$I_F=100\text{mA}$		0.51	0.80	V
$C_J$	$V_R=1.0\text{V}, f=1.0\text{MHz}$		7.0		pF

**CMDSH-3**  
**SURFACE MOUNT SILICON**  
**SCHOTTKY DIODE**



**SOD-323 CASE - MECHANICAL OUTLINE**

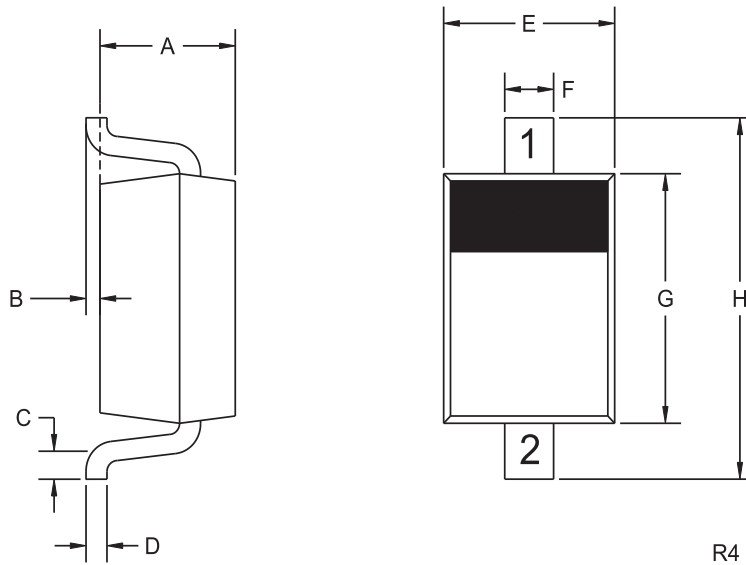

**LEAD CODE:**

- 1) Cathode
- 2) Anode

**MARKING CODE: S1**

SYMBOL	INCHES		MILLIMETERS	
	MIN	MAX	MIN	MAX
A	0.031	0.039	0.80	1.00
B	0.000	0.004	0.00	0.10
C	0.008	-	0.20	-
D	0.004	0.007	0.11	0.19
E	0.045	0.053	1.15	1.35
F	-	0.014	-	0.35
G	0.063	0.071	1.60	1.80
H	0.094	0.102	2.40	2.60

SOD-323 (REV: R4)

R9 (11-February 2016)

**CMDSH-3**  
**SURFACE MOUNT SILICON**  
**SCHOTTKY DIODE**



**TYPICAL ELECTRICAL CHARACTERISTICS**

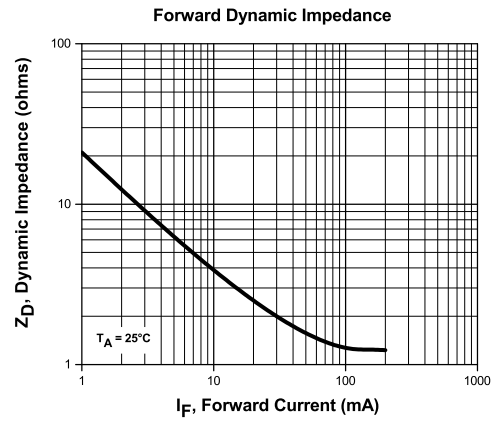
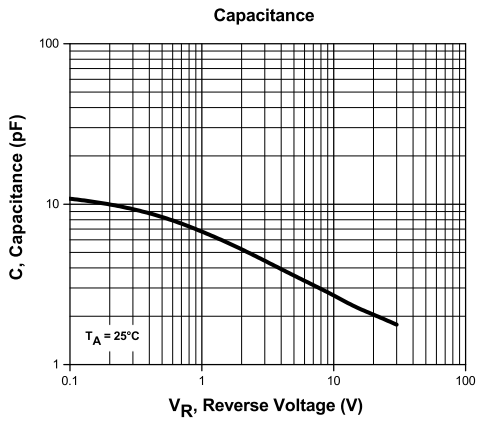
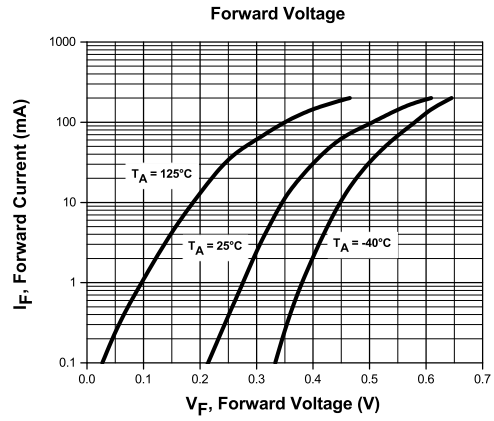
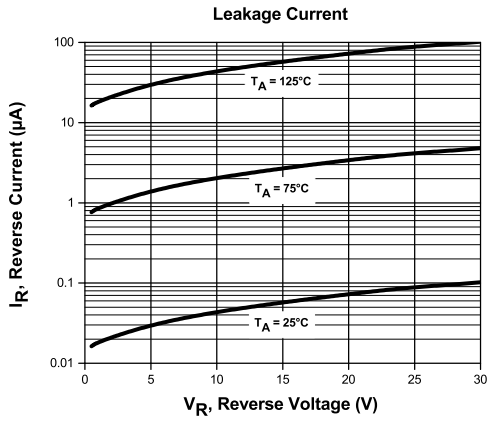

R9 (11-February 2016)

**CMDSH-3**  
**SURFACE MOUNT SILICON**  
**SCHOTTKY DIODE**



**TYPICAL ELECTRICAL CHARACTERISTICS**

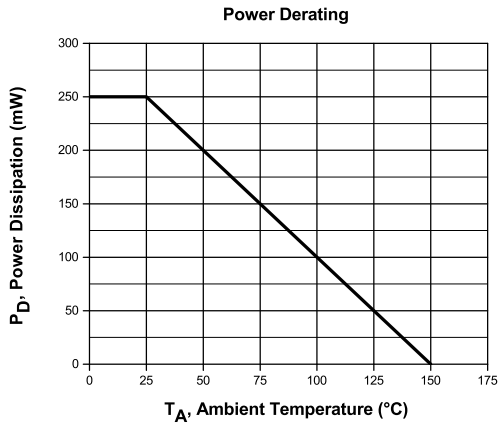
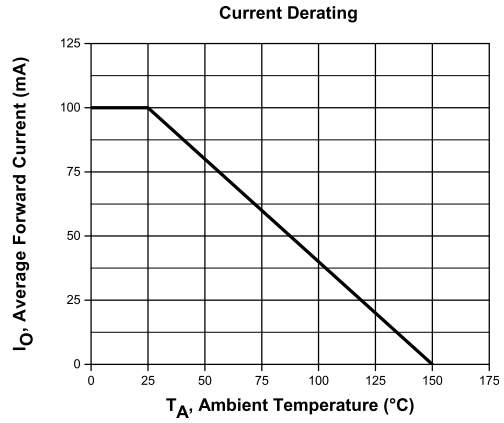
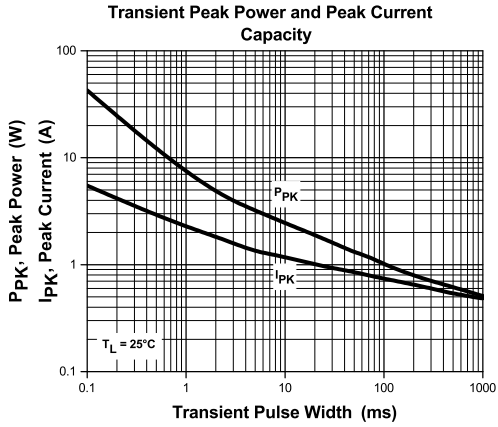

R9 (11-February 2016)

## OUTSTANDING SUPPORT AND SUPERIOR SERVICES



---

### PRODUCT SUPPORT

Central's operations team provides the highest level of support to insure product is delivered on-time.

- Supply management (Customer portals)
- Inventory bonding
- Consolidated shipping options
- Custom bar coding for shipments
- Custom product packing

---

### DESIGNER SUPPORT/SERVICES

Central's applications engineering team is ready to discuss your design challenges. Just ask.

- Free quick ship samples (2<sup>nd</sup> day air)
- Online technical data and parametric search
- SPICE models
- Custom electrical curves
- Environmental regulation compliance
- Customer specific screening
- Up-screening capabilities
- Special wafer diffusions
- PbSn plating options
- Package details
- Application notes
- Application and design sample kits
- Custom product and package development

---

### REQUESTING PRODUCT PLATING

1. If requesting Tin/Lead plated devices, add the suffix " TIN/LEAD" to the part number when ordering (example: 2N2222A TIN/LEAD).
2. If requesting Lead (Pb) Free plated devices, add the suffix " PBFREE" to the part number when ordering (example: 2N2222A PBFREE).

---

### CONTACT US

#### Corporate Headquarters & Customer Support Team

Central Semiconductor Corp.  
145 Adams Avenue  
Hauppauge, NY 11788 USA  
Main Tel: (631) 435-1110  
Main Fax: (631) 435-1824  
Support Team Fax: (631) 435-3388  
[www.centrasemi.com](http://www.centrasemi.com)

**Worldwide Field Representatives:**  
[www.centrasemi.com/wwreps](http://www.centrasemi.com/wwreps)



**Worldwide Distributors:**  
[www.centrasemi.com/wwdistributors](http://www.centrasemi.com/wwdistributors)

---

For the latest version of Central Semiconductor's **LIMITATIONS AND DAMAGES DISCLAIMER**, which is part of Central's Standard Terms and Conditions of sale, visit: [www.centrasemi.com/terms](http://www.centrasemi.com/terms)

## Looking for pricing, stock, or lifecycle information?

Click below to explore more details on WIN SOURCE:

-  [View CMDSH-3 TR on WIN SOURCE](#)
-  [Central Semiconductor Corp Information](#)

## Optimize Your Supply Chain with WIN SOURCE Solutions

-  Global Sourcing Solution
-  Obsolete Management
-  Cost Control Management
-  Shortage Management
-  Alternative Solution
-  Excess Inventory Management